

June 1987 • Volume 10 • Issue 6

£1.50

PRACTICAL COMPUTING

FOR BUSINESS AND PROFESSIONAL MICRO USERS



IBM'S NEW STANDARD

HARDWARE Microvax 2000 • Kaypro 386

SOFTWARE Carbon Copy • Money Power

FEATURES Computer disasters

PLUS Colour DTP on the Mac

The secret of Borland's success is "Quality, Speed, Power, & Price"

We're one of the biggest software companies in the world—and we got that way by making "Quality, Speed, Power, & Price" essential characteristics of every Borland software program. Look for Borland software—then look no further.



Turbo Prolog™

Our new Turbo Prolog has drawn rave reviews—which we think are well deserved—because Turbo Prolog brings 5th-generation language and super-computer power to your IBM PC and compatibles. Turbo Prolog is a high-speed compiler for the artificial intelligence language, Prolog, which is probably one of the most powerful programming languages ever conceived. We made a worldwide impact with Turbo Pascal, and you can expect the same results and revolution from Turbo Prolog, the natural language of Artificial Intelligence. Minimum memory: 384K.

Reflex® and Reflex Workshop™

No matter what business you're in, if you use Lotus 1-2-3® or dBASE® you need Reflex and the new Reflex Workshop to give you all the tools and views to see what your numbers mean. The new Reflex 1.1 with expanded memory support allows you to manage huge databases of up to 8 megabytes of RAM, 32,000 records, and 250 fields per record with "Reflex Lightning Speed." The Reflex Workshop gives you a wide range of analytical tools written for specific applications like Finance/Accounting, Administration, Sales and Marketing, and Production and Operations. You can use the tools "as is" or modify them to suit your business needs. Minimum memory: 384K.

SuperKey™ Turns 1000 Keystrokes Into 1!

If you use SideKick, you need SuperKey. They're designed to work together—and work for you. SuperKey's an amazing keyboard enhancer for your IBM PC and compatibles. With easy-to-write macros, you and SuperKey can turn 1000 keystrokes into 1. Minimum memory: 128K.

SideKick® Instant Desktop Management!

Powerful desktop management program and the #1 best seller for the IBM PC. SideKick includes notepad, calendar, calculator, appointment scheduler, telephone directory, autodialer, and ASCII table. It's RAM-resident—which means SideKick is always there ready to react when you need to do something, call someone, or find out something in a hurry. And it does all this while you run other programs. Minimum memory: 128K.

Traveling SideKick™

It's the electronic organizer for this electronic age. Neither you nor your secretary need to face 1987 with old-fashioned 1887 diaries. Traveling SideKick has everything they have—and a lot more. (Unlike dusty old diaries, Traveling SideKick doesn't "expire" at the end of '87, because it's electronic and good for '88, '89, '90 and on and on and on.) It's a professional binder, a software program, and a report generator—a modern business tool that prints your ever-changing appointments in daily/weekly/monthly/yearly form. (If your schedule changes hourly, Traveling SideKick handles the changes instantly.) Whether you use your own personal computer or have someone's help with that, Traveling SideKick is the smart new way to take your computer with you—without taking your computer with you. Minimum memory: 256K.

Turbo Lightning® Solves All Your Spelling Problems!

While you use SideKick, Reflex, Lotus 1-2-3®, and most popular programs, Turbo Lightning proofreads as you write! If you misspell a word, Turbo Lightning will beep at you instantly, and suggest a correction for the word you just misspelled. Press one key, and the misspelled word is immediately replaced by the correct word. And if you're ever stuck for a word, Turbo Lightning's thesaurus is there with instant alternatives. Minimum memory: 256K.

Lightning Word Wizard™ Technical Reference Manual For Turbo Lightning!

An important addition to Turbo Lightning, Lightning Word Wizard includes fascinating and challenging word games like "Akerue" (try reading that backwards), "That's Rite," "CodeCracker," "CrossSolver," "MixUp," and "FixUp," to name some of them. Lightning Word Wizard introduces you to the "nuts and bolts" of Turbo Lightning technology, and gives you more than 20 different calls to the Lightning engine. Minimum memory: 256K.



Turbo Pascal, the worldwide standard in high-speed compilers, and Family.

Turbo Database Toolbox™

A perfect complement to Turbo Pascal, because it contains a complete library of Pascal procedures that allows you to search and sort data and build powerful database applications. It comes with source code for a free sample database—right on disk. Minimum memory: 128K.

Turbo Editor Toolbox™

Recently released, we call our new Turbo Editor Toolbox a "construction set to write your own word processor." Source code is included, and we also include MicroStar, a full-blown text editor with pull-down menus and windowing. It interfaces directly with Turbo Lightning to let you spell-check your MicroStar files. Minimum memory: 192K.

Turbo GameWorks®

Turbo GameWorks is what you think it is: "Games" and "Works." Games you can play right away (like Chess, Bridge and Go-Moku), plus the Works—which is how computer games work. All the secrets and strategies of game theory are there for you to learn. You can play the games "as is" or modify them any which way you want. Source code is included to let you do that. Minimum memory: 192K.

Turbo Tutor™ 2.0

The new Turbo Tutor can take you from "What's a computer?" through complex data structures, assembly languages, trees, tips on writing long programs in Turbo Pascal, and a high level of expertise. Source code for everything is included. New split screens allow you to put source text in the bottom half of the screen and run the examples in the top half. There are quizzes that ask you, show you, tell you, teach you. Minimum memory: 192K.

Turbo Graphics Toolbox™

Includes a library of graphics routines for Turbo Pascal programs. Lets even beginning programmers create high-resolution graphics with an IBM® Hercules™ or compatible graphics adapter. Our Turbo Graphics Toolbox includes all the tools you'll ever need for complex business graphics, easy windowing, and storing screen images to memory. It comes complete with source code, ready to compile. Minimum memory: 192K.



Turbo C: The fastest, most efficient and easy-to-use C compiler at any price

Turbo C: The fastest, most efficient and easy-to-use C compiler at any price.



Compilation speed is more than 7 000 lines a minute, which makes anything less than Turbo C an exercise in slow motion. Expect what only Borland delivers: Quality, Speed, Power and Price.

Turbo C: The C compiler for amateurs and professionals

If you're just beginning and you've "always wanted to learn C" now's your chance to do it the easy way. Like Turbo Pascal, Turbo C's got everything to get you going. If you're already programming in C, switching to Turbo C will considerably increase your productivity and help make your programs both smaller and faster. Actually, writing in Turbo C is a highly productive and effective method - and we speak from experience. Eureka: The Solver™ and our new generation of software have been developed using Turbo C.



£89.95

Free MicroCalc spreadsheet with source code

Turbo C: a complete interactive development environment

Like Turbo Pascal® and Turbo Prolog™, Turbo C comes with an interactive editor that will show you syntax errors right in your source code. Developing, debugging, and running a Turbo C program is a snap.

Turbo C: The C compiler everybody's been waiting for. Everybody but the competition

Borland's "Quality, Speed, Power and Price" commitment isn't idle corporate chatter. The price tag on Turbo C isn't a "typo", it's real. So if you'd like to learn C in a hurry, pick up the phone. If you're already using C, switch to Turbo C and see the difference for yourself.

Steve benchmark (25 iterations)

	Turbo C	Microsoft®C	Lattice C
Compile time	3.89	16.37	13.90
Compile and link time	9.94	29.06	27.79
Execution time	5.77	9.51	13.79
Object code size	274	297	301

Benchmark run on a 6 Mhz IBM AT using Turbo C version 1.0 and the Turbo Linker version 1.0; Microsoft C version 4.0 and the MS overlay linker version 3.51; Lattice C version 3.1 and the MS object linker version 3.05.

Technical Specifications

- Compiler.** One-pass compiler generating linkable object modules and inline assembler. Included is Borland's high performance "Turbo Linker". The object module is compatible with the PC-DOS linker. Supports tiny, small, compact, medium, large, and huge memory model libraries. Can mix models with near and far pointers. Includes floating point emulator (utilises 8087/80287 if installed).
- Interactive Editor:** The system includes a powerful, interactive fullscreen text editor. If the compiler detects an error, the editor automatically positions the cursor appropriately in the source code.
- Development Environment:** A powerful "Make" is included so that managing Turbo C program development is highly efficient. Also includes pull-down menus and windows.
- Links with relocatable object modules** created using Borland's Turbo Prolog into a single program.
- ANSI C compatible.**
- Start-up routine source code included.**
- Both command line and integrated environment versions included.**

YES! I want the best!

Copies	Product	Price	Totals
___	Turbo C	£ 89.95	£ ___
___	Turbo Basic	69.95	£ ___
___	Turbo Pascal (PC/MS-DOS)	69.95	£ ___
___	Turbo Pascal (Amstrad CP/M)	59.95	£ ___
___	Turbo Prolog	69.95	£ ___
___	Reflex: the Database Manager	*129.95	£ ___
___	Reflex Workshop	*69.95	£ ___
___	Reflex & Reflex Workshop	**129.95	£ ___
___	Turbo Numerical Methods Toolbox	69.95	£ ___
___	Turbo Database Toolbox	49.95	£ ___
___	Turbo Graphix Toolbox	49.95	£ ___
___	Turbo Tutor 2.0	39.95	£ ___
___	Turbo Editor Toolbox	49.95	£ ___
___	Turbo GameWorks	49.95	£ ___
___	Turbo Lightning	69.95	£ ___
___	Lightning Word Wizard	49.95	£ ___
___	Turbo Lightning & Lightning Word Wizard	99.95	£ ___
___	SideKick	69.95	£ ___
___	Travelling SideKick	69.95	£ ___
___	SideKick & Travelling SideKick	125.00	£ ___
___	Superkey	69.95	£ ___
___	Turbo Jumbo Pack	245.00	£ ___
___	Outside UK add £10		£ ___
___	shipping per copy		£ ___
___	Add 15% VAT		£ ___
___	Amount enclosed		£ ___

Prices include shipping to all UK cities
Carefully describe your computer system:
Mine is: ___ 8 bit ___ 16 bit
I use ___ PC-DOS ___ CP/M 80
___ MS-DOS ___ CP/M 86
My computer's name and model is _____

The disc size I use is 5 1/4" 3 1/2" 3"
Payment: Access Visa Money order Cheque
Credit card expiration date _____
Card No. _____

Signature _____
Name: _____
Shipping Address: _____

Postal Code: _____
Telephone: _____

CODs and purchase orders WILL NOT BE accepted by Borland. Outside UK make payment by credit card or International Postal Money Order
*New U.K. version

**Time limited promotional offer
NOT COPY PROTECTED
60 DAY MONEY-BACK GUARANTEE

If within 60 days of purchase you find that this product does not perform in accordance with our claims call our customer service department and we will gladly arrange a refund.
All prices are suggested list prices and are subject to change without notice.

BORLAND INTERNATIONAL Department A6
1, GREAT CUMBERLAND PLACE,
LONDON W1H 7AL
(01) 258-3797

Vive la différence

→ circle 129 on enquiry card ←

System requirements
IBM PC, XT, AT and true compatibles, PC-DOS (MS-DOS) 2.0 or later,
1 floppy drive, 320 k.

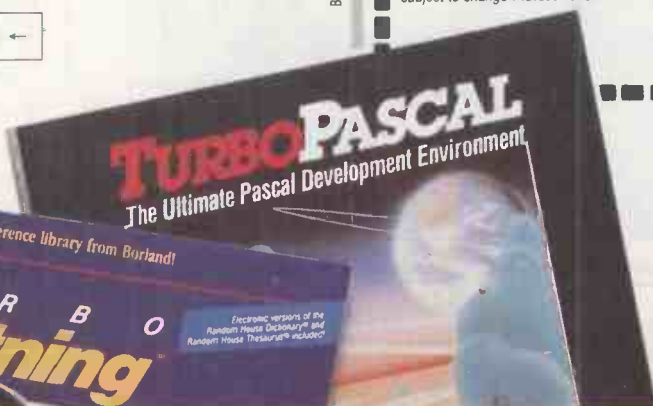
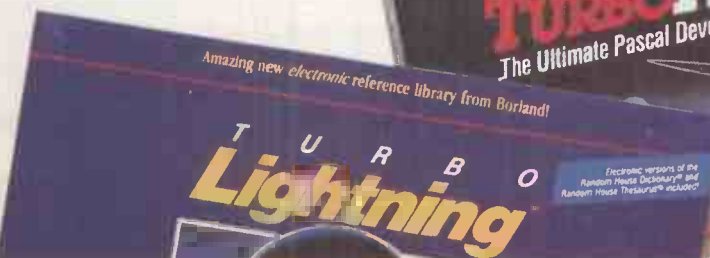

BE 10/2



Olivetti's new M15.

The desk top computer for people without desk tops.

If, like our antiquated architect, you're a businessman who spends a lot of time out in the field, you're sure to welcome the arrival of the new Olivetti M15.

A lightweight computer with heavyweight capabilities.

It weighs in at only 12½lbs – but packed into that 12½lbs is all the performance of a desk top PC.

A 512 KB memory.

Twin integrated 3½" disk drives, with the capacity to transfer data and programmes to and from an external 5¼" drive.

A full 10½" tiltable screen – larger than any other portable. (With normal monitor proportions, to prevent picture distortion.)

And, of course, the standard MS-DOS operating system – making the M15 fully compatible with industry software and hardware.

So you can run all the programmes you've got in the office, out of the office.

The M15 has a dual power supply – 6 hour rechargeable batteries, or mains.

A detachable keyboard – so you don't have to have the whole thing on your lap.

And to round the package off, the computer comes complete with its own holdall. And the service and back-up you'd expect from Europe's leading PC manufacturer.

What you might not expect is the extremely competitive price:

For more information, simply send off the coupon, or talk to your local dealer.

*£1355 for the complete system.

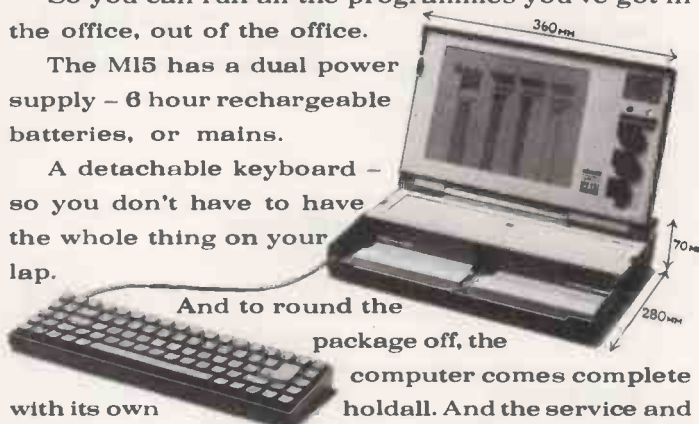

To: Carol White, British Olivetti Limited, Olivetti House, 86-88 Upper Richmond Road, London SW15 2UR. 01-785 6666. I'll be out of the office soon. Please send me details of the Olivetti M15 computer.

Name _____ Position _____

Company _____ Address _____

Postcode _____

Tel. No. _____

olivetti
YOUR PERSONAL SOLUTION

PC 87



THE NEW IBMs

They are here at last: IBM has unveiled its next generation of machines. But instead of clarifying the situation they seem to have spread nothing but fear, uncertainty and doubt. In this special section we give a detailed analysis of the implications for companies, what the new hardware standards are, how well the equipment performs, and look at OS/2 in detail

85



IBM PS/2 The full range of models in detail — page 91.

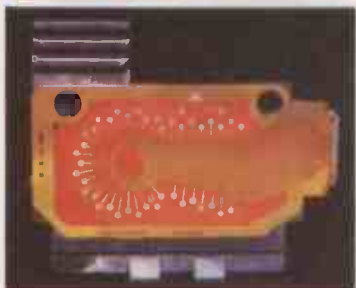

Quietwriter III Quality thermal printer — page 98.

PRACTICAL COMPUTING

JUNE 1987 CONTENTS

DEC MICROVAX 2000

Against a background of IBM launches, DEC has further strengthened its line with this low-end Vax system

42

KAYPRO 386

Kaypro has joined the 386 club. *Steve Malone* tries out its latest machine

46

HP LASERJET II

Ian Stobie looks at Hewlett-Packard's revamped printer. Is it good enough to keep the company ahead?

50

XPRESS

The new Mac II opens up the possibility of full-colour DTP. *Carol Hammond* looks at one of the programs to exploit it

54

PRIME TIME

Organising your time is crucial, but is a micro the best way to do it? We try out one solution

58

CARBON COPY

Mike Lewis looks at a package which lets you run a PC application down the phone

65

LOW-COST CALCS

Not all spreadsheets look like 1-2-3. *Glyn Moody* reviews some bargain offerings which take an independent line

67

KODAK DATASHOW

A new idea in presentation technology based around LCDs and overhead projectors, tested out by *Ian Stobie*

72

XEROX

Steve Malone finds out what is coming next from the company which invented networking, DTP and laser printers

75

COMPUTER DISASTERS

A computer breakdown can be a business catastrophe. *Carol Hammond* explains how to minimise its effects

78

DISTRIBUTORS' DEAL

You buy from a dealer who buys from a distributor. We report on the big three and their attitudes to the industry

81

MS-DOS UTILITIES

Deleting files is made quicker and safer with this program from *Jim Bates*

109



Microvax 2000 DEC's mini mini — page 42.



Xpress Colour DTP for the Macintosh — page 54.

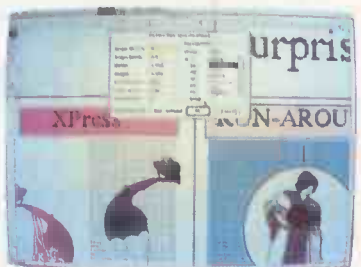

NEWS

HARDWARE NEWS

Mac II expansion cards **10**

SOFTWARE NEWS

Lotus/IBM joint venture **12**

GENERAL NEWS

Profits up **16**

REGULARS

EDITORIAL

Workers' power.....**7**

FEEDBACK

Your letters.....**9**

COMMS LINK

Textline.....**21**

SOFTWARE WORKSHOP

Graphics programming....**27**

CHIP-CHAT

Memory moves on.....**34**

LEGAL STATEMENTS

Is copying legal?.....**37**

ASK PC

You ask, we answer.....**39**

TOP 10

On-line info.....**102**

BOOKS

Best of the bunch.....**105**

What's the colour of your money?



80p*

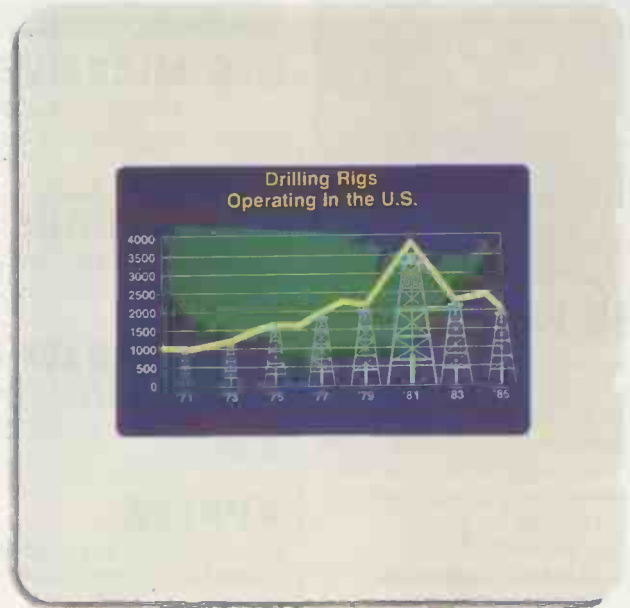

The slide on the left was made by a Polaroid Palette computer image recorder in under half an hour for under a pound. The slide on the right was produced by an outside agency for about a hundred pounds more.

It's an odd world when some people are prepared to pay more money to get less and take longer over it.

With Polaroid's Palette you can produce 35 mm colour slides, overheads and prints at a fraction of the cost and time. You can also update your information right up to the last few minutes before a presentation. And all along, you're in full control of the colour you want. (And also in full control of who exactly will see the information on the slide. This means it's completely confidential.)

The colour you get from our Palette is the perfect way to add a smooth finish to your presentation. And not paint your bank balance red. For further information fill in the coupon below.



*Based on the cost of origination of twelve slides using Polaroid's new High Contrast Polachrome film.

For further information on the Polaroid Palette computer image recorder return this coupon or call: Ray Taylor, Polaroid (UK) Ltd, Ashley Road, St. Albans, Herts. AL1 5PR. Tel St. Albans 07072 78283.

Name _____ Position _____

Company _____

Address _____

Tel _____

 **Polaroid**
Instant Presentations

*Polaroid is a regd. trademark of the Polaroid Corporation, Mass., USA

→ circle 131 on enquiry card ←

EDITORIAL 01-661 3633 Telecom Gold 81:RPL002

▷ PUBLISHER/EDITOR GLYN MOODY DEPUTY EDITOR (Production) JOHN LIEBMAN ART EDITOR HUGH ANDERSON ASSISTANT EDITOR IAN STOBIE
TECHNICAL EDITOR STEVE MALONE REPORTER CAROL HAMMOND CONSULTANTS JACK SCHOFIELD, MIKE LEWIS
ADVERTISING 01-661 3612 ▷ ADVERTISEMENT MANAGER NEIL MARCHANT 01-661 3021
ADVERTISEMENT EXECUTIVES KATE SCALLY 01-661 8425 JANET THORPE 01-661 3468 MIDLANDS AND NORTH 061-872 8861
ADVERTISEMENT PRODUCTION CONTROL JACKIE PERRY 01-661 8649 BRIAN BANNISTER 01-661 8648
SECRETARY LYNN DAWSON CLASSIFIED SUSAN PLATTS 01-661 3033

TIME TO ARM THE WORKERS

Ask any manager: the most important people in a company are not the salesmen and women, even though they bring in the money; not the accounts department, even though they handle the money; not even the managing director, who decides what to do with the money. Rather, it is the secretaries, wherever they may be, and whomever they may serve.

Their task is nothing less than the smooth running of the office. Where others are concerned with the nitty-gritty of the company's activities, secretaries are the great generalists. Typically they are responsible for information flow in the form of typed documents, filing, time-scheduling and taking messages. Put another way, they are the human equivalent of word processors, databases, spreadsheets and comms packages.

Against this background, consider a typical pattern of introducing micros into the office. Senior management cottons on to the fact that micros seem to be no bad thing. Standards are set, and official machines specified — much like the company car policy. Indeed, the approach taken with company cars is an irresistible model for the allocation of micros. As a result, directors end up with Toshiba 3100s. Nominally the rationale behind this is that they need compatibility combined with the portability that will allow them to take work home. In reality, the Toshiba scores because its sleek, dark lines make it look the part as a top executive's personal computer. As far as working at home is concerned, it would be far simpler — and cheaper — to give everyone a second desk-top micro.

Further down the ladder, senior managers might get PC/ATs and the line managers IBM PCs. Everyone else probably ends up with an Amstrad or the like. Secretaries are lucky if they get an electronic typewriter with a single-line LCD. For such key workers, most of whose tasks are crying out for a micro, this is madness.

Companies must learn that machines need to be introduced bottom up rather than top down. Possessed of a shiny new micro, many managers find they lack the time or the inclination to grapple with its details. The likely benefit seems too intangible. Even if they are converted to the joys of the spreadsheet — as most soon are — they will remain sceptical of other functions like word processing and databases, both of which require heavy typing input.

For the secretary, on the other hand, there are no such problems. Not burdened with their bosses' aversion to the keyboard, secretaries soon appreciate that the micro can liberate them from the drudgery of their work. Repetitive typing is no longer repetitive once it is possible to incorporate revisions by means of a few keystrokes. Maintaining files becomes a civilised pleasure if the computer does the sorting and sifting, and continuous updating is trivial.

Companies may well come to accept that it is sensible to give micros to secretaries as well as to their managers. True, this will require an effort of corporate willpower to overcome deep-

rooted prejudices about status and its visible trappings. After all, giving a secretary a PC/AT or equivalent — which is what every secretary should have — is, in the eyes of some hierarchy-conscious diehards, like giving sales reps Porsches instead of Astras.

But even assuming companies are sufficiently brave about buying the machines in the first place, it is unlikely that they will be mature enough to face up to the inevitable corollary of such a move. For once secretaries gain tools which complement their working patterns so closely it will become clear that they are not only the most crucial resource in a company, but also its most underutilised one.

No longer tied to mindless retyping of standard letters, pointless filing of carbon copies or fruitless attempts at making telephone calls, secretaries will find themselves with time on their hands and — more importantly — skills as well. The power of their computers will allow them to broaden their role within the office. They will become flexible office assistants, providing a range of in-house resources.

Graphics packages will turn them into art departments; desk-top publishing and laser printers will make them personal-publishing divisions; commercial databases accessed either down the phone or from CD-ROMs will transform them into research libraries. Ultimately, with the development of viable expert systems, a time could come when secretaries take over completely. Which would just go to prove what many managers secretly fear: that it is they, not their secretaries, who are dispensable.

5 YEARS AGO...

For several months now there have been rumours that ICL is going into the microcomputer business in a big way. First came the news that the British computer giant was going to market the Rair Black Box range of microcomputers under an ICL label. Now the company's plans are brought into perspective by its Trader Point scheme.

Trader Point is, as its name suggests, a marketing strategy. It is a bold venture, both from the point of view of ICL and the dealers who enter into agreements with it. Because ICL knows little about the micro market, it is prepared to lend its name and expertise to the dealers who, in return, will sell the machines for ICL. Some dealers are expressing concern that they will be competing for sales against ICL salesmen. Others are worried that the lack of local licence agreements will usher in cut-throat selling, signifying the destruction of their businesses.

Despite these fears, the microcomputing industry should benefit by this new development. Trader Point is not just concerned with selling the new ICL microcomputer, though the machine should make up the bulk of these sales.

The ICL personal computer is expected to sell in very large quantities. According to the sales team at ICL, the biggest buyers will be large international and national companies. The main competition is expected to be the IBM personal, which is not yet officially on sale in Europe.

Volume 5 Issue 6

How to make sure your Printer doesn't slow your PC down.



Without a Megabuffer your Printer can slow down the rate your PC outputs to the rate your Printer prints. Turning a 5 minute print file into half-an-hour. Which means that the PC can be out of action for long periods. Merely outputting. With a Megabuffer the PC outputs at its top speed into the Megabuffer memory, the PC is then released for further work, and the Printer prints at its own rate from the Megabuffer memory.

- Allows you to use your PC more
- Can emulate special plotter handshake protocols
- Compatible with most computers, printers and plotters: IBM & compatibles, AMSTRAD, HP, ACT, SHARP, EPSON, CALCOMP and many more • Can cut PC output time to one sixth or less.
- Software-independent
- Data Buffer and interface converter
- Pause, 'reprint page' and multiple copy facilities

Full range of memory sizes for every application: 64K **£160**, 128K **£216**, 256K **£278**, 512K **£388**, 1MB **£556**.

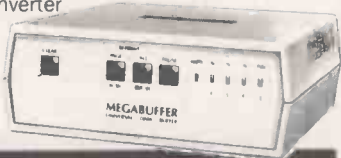

Flexible Interfacing that keeps them all talking

Eliminate miles of spaghetti and all those 'T' and 'X' switches with a simple Megaswitch which allows your PC to instantly connect to a selection of printers and plotters.

MEGASWITCH AS - Serial Data Selector

- Single unit multiplexer and demultiplexer • 2K data buffer
 - RS-232 and RS-422 versions • Can operate as RS-232/RS-422 converter • Diagnostic output • Megabuffer compatible
 - Multiplexer - Ideal for printer sharing. 4 inputs and 2 outputs. Can automatically select any channel supplying data
 - Demultiplexer - Ideal for driving several different printers from a PC. 2 inputs and 4 outputs
- Software and manual selection. Downloadable code translation tables. Hardware and XON/XOFF handshakes

(RS-232) **£189**



INPUT UP TO 5 PCs

MEGASWITCH S - RS232 Serial Selector

- Connects any of 5 inputs to either of 2 outputs
- Universally compatible - works with all baud rates and handshake arrangements
- LED indication of data flow
- Use it with a Megabuffer for additional time saving **£99**



OUTPUT UP TO 2 PRINTERS UP TO 2 PLOTTERS

RINGDALE PERIPHERALS

11 Decoy Road, Worthing, West Sussex BN14 8ND
Telephone (0903) 213131
Telex 265871 REF: JBC2021

MEGASWITCH AP - Parallel Data Selector

- Connects any of 4 inputs to either/both of 2 outputs
- Can automatically switch to any channel supplying data
- Ideal for laser printer sharing
- Universally compatible - works with all standard centronics computer and printer interfaces
- Use it with a Megabuffer for additional time saving **£169**

UK delivery £3/UNIT, cables from £15. VAT extra Dealer and Export Enquiries welcome

→ circle 132 on enquiry card ←

NEXT MONTH

SOFTWARE

We look at the latest version of **WordStar** and how it shapes up against the latest generation of word processors. And there is a review of **Aldus Pagemaker** for the IBM PC: will it dominate in the PC world the way it has on the Mac? Ashton-Tate's mid-range database **Rapid File** also comes under scrutiny.

HARDWARE

Laser printers are one of the hottest areas around, and things are likely to get even hotter following the recent launch of a low-cost model from **Epson**. And following our preview of the new Macs, we take a detailed look at the **Mac SE**.

FEATURES

How will the current chip war affect business micros? We look at what is at stake and discuss the likely knock-on effects. We will also be surveying one of the most neglected areas of microcomputing: **consumables**. How much do we use, who makes them, and what changes are there in the industry?

SPECIAL SECTION

UNIX AND ITS RIVALS

Unix has been around for a long time, and shows no sign of going away. The recent announcement of OS/2 confirms that the DOS world is staying strictly single-user, so is Unix's victory inevitable? We look at what's happening now in the world of Unix, Pick and the rest, and what could happen soon.

TOP 10

ADD-ON BOARDS

We survey the best things to perk up your PC.

Don't miss the July issue of

PRACTICAL COMPUTING

On sale at W H Smith and all good newsagents after 17 June.

Contents may vary due to circumstances beyond our control and are subject to change without notice.

Quintet

WITH reference to the Top 10 Spreadsheets feature in your April issue. I would like to correct one error: Grafox never announced a product called Quintet, and has no expectation of doing so.

IAN McCALLA,
Grafox,
Oxford.

DAVID BARLOW REPLIES: My apologies. The Quintet integrated package is distributed not by Grafox but by Graffcom Systems, CP House, 97-107 Uxbridge Road, London W5 5TL; telephone 01-579 9407. In addition to the single-user MS-DOS package a multi-user version is available, running under Concurrent DOS.

Bromcom QC

WE WOULD like to point out that the Bromcom QC, reviewed in your January issue, does not use the Commissionaire package mentioned in April's Feedback. The Bromcom QC has its own Quic front-end software built-in, which is produced and designed by Bromcom.

DEIRDRE CARGILL,
Bromcom Computers,
Bromley,
Kent.

Mace superbug

IN your February issue I read Ian Stobie's review of Mace, a package which claims to improve disc performance but which actually trashes your directory. I was appalled!

We run a data-recovery service and often meet discs that have been corrupted by accident, accidentally formatted or have had a mass of files deleted. The mind boggles at the thought that there is a program around which will cause such a problem systematically. There should be a word stronger than bug to describe programs that don't just not work, but stop your entire computer from working — I suggest Superbug.

Your reviewer did a backup before running the program but many people would not. I think that you should ask the supplier in the strongest possible terms to withdraw the program from sale. We get enough corrupted discs coming through our doors as it is, without a new flood caused by a superbug.

ALAN SOLOMON,
S&S Enterprises,
Amersham,
Buckinghamshire.

In our Feedback columns readers have the opportunity of bringing their computing experience and problems to the attention of others, as well as of seeking our advice or making suggestions, which we are always happy to receive. Make sure you use Feedback — it is your chance to keep in touch.

WRITE TO:

Feedback, Practical Computing, Quadrant House,
The Quadrant, Sutton, Surrey SM2 5AS

WHITE ELEPHANTS

WHILE sympathising with Jack Schofield's April Comms Link article on many points I cannot help thinking that the French Teletel system may yet prove to be a telecomms Maginot Line. Like the IBM standard, fixed ad hoc systems often later prove to be unwieldy and inflexible, and not as successful as progress in diversity would achieve.

Perhaps BT's hesitant progress with Systems X, to allow for changing technology and future requirements, indicates our British preference for flexibility. The French tendency to single-minded commitment contrasts with our methods. After all, there is something to be said for cautious appraisal. It's all too easy to rush into vast developments which eventually become white elephants mainly because basic assumptions were not determined at the right time.

ERIC A COOK,
Cwmbrân,
Gwent.

WordStar without backups

IN response to A P Saunders-Davies's question in the March Ask PC column about avoiding the creation of .Bak files in WordStar, I would like to suggest the following solution.

First, to edit an existing file — say, Demo.Txt — do not open this file. Instead open a new file by any name: Dummy, for example. Once in the Edit menu, read the file Demo.Txt by typing.

^KR

You can then edit or modify the file as you wish.

To save the edited version do

not type ^KD, ^KX or ^KS, as this would save under the name Dummy, which is not what you want. Go to the beginning of the file by keying

^QR

Mark the beginning of a block by pressing

^KB

Then go to the end of the file by typing

^QC

and then type

^KK

to mark this position as the end of a block. You then simply type

^KW

to save your edited file.

At the WS prompt type

^DEMO.TXT

or

^R

TURBO PASCAL COMPETITION

THIS is your last chance to win a trip to California to visit the headquarters of Borland International. Other prizes include the complete range of Borland products. Entries to the Turbo Pascal Competition must arrive at the *Practical Computing* offices not later than 31 May.

To win one of the many prizes, all you need to do is submit a program written in Turbo Pascal. Programs do not have to be complete applications; useful routines and utilities are equally acceptable. Nor do they have to be large-scale: a short, well-written piece of code is just as likely to win. For full details and entry form see the March or April issue of *Practical Computing*. Alternatively, you can obtain a copy of the entry form by phoning the magazine's office.

followed by Return. You then abandon the edit session by pressing

^KQ

and exit WordStar as usual.

The whole procedure may seem very involved and clumsy, but with a little practice and patience an experienced user can make it work without any problem.

M A RAHIN,
University of Technology,
Loughborough,
Leicestershire.

Amstrad user group

AMSFED INTERNATIONAL, formerly the Amstrad Groups Federation, has been set up to act as an umbrella organisation for the multitude of Amstrad user groups which have been established worldwide.

It supplies a bi-monthly magazine to all groups, provides a bulletin-board service and offers access to public-domain software. We already have an extensive list of affiliates from all over the world and we shall be happy to put any of your readers in touch with his or her local group.

C HEYLIGER,
Amsfed International,
41 Adams House,
Millwall Close,
Gorton,
Manchester M18 8LL.

C books review

I WAS pleased to see Steve Malone's review of my book *C for Professional Programmers*. I would however like to comment on his concern as to possible errors in the programs.

The script of the book was typed into a Unix-based mini-computer by myself and all the programs were tested on that machine. The text, including the program listings, were transferred to a microcomputer and thus to a floppy disc from which it was set.

I wish to assure you that all the programs were tested and should contain no errors.

KEITH TIZZARD,
University of Exeter.

Novell Netware

IN your article on Novell Netware in *Practical Computing's* April issue an incorrect phone number was printed. The correct telephone number for Novell is (0892) 47833.

JON GOULD
Novell Data Systems,
Tunbridge Wells,
Kent. 

Spectrum Group PC clones

SPECTRUM GROUP, one of the U.K.'s largest hardware distributors, has introduced a selection of products ranging from an XT-compatible micro to a network and a dot-matrix printer.

At the bottom of the range is the SBC FD and HD-20 PC/XT-compatible computers. Featuring the NEC V-40 processor running at either 5.5MHz or 8MHz, the computers have 640K of RAM as standard. They are also fitted with serial and parallel ports, monitors and come complete with MS-DOS 3.2 and GWBasic. Prices start at £599 for a twin-floppy model complete with monochrome monitor, rising to £1,199 for the colour model with one floppy and a 20Mbyte hard disc.

Further up the scale, Spectrum has launched an AT compatible called the SBC Mistral 286AT. It comes with a 30Mbyte hard disc as standard, and has clock speeds that are switchable between 6MHz, 8MHz and 12MHz. Prices for the machine start at £1,799.

The multi-user networking system consists of a Mistral AT and three SBC FDs connected together with Spectrum's own SBC-Net. The total price of the package, to be called System M, comes to £4,500. Spectrum says that up to 255 stations can be connected to the network.

Details are available from Spectrum Group, Hunting Gate, Hitchin, Hertfordshire SG4 0TJ. Telephone: (0462) 37171.



Spectrum's Mistral 286AT.

MACINTOSH EXPANSION FROM AST

AST, one of the leading manufacturers of expansion cards for the IBM PC, is to launch boards for the Macintosh II and Macintosh SE. Among the features on offer are the ability to run MS-DOS, the possibility of turning the machine into a multi-user engine, and memory expansion to 4Mbyte.

The Mac-286 is the IBM emulation option. The two full-length expansion cards which make up the system hold an 80286 processor and 1Mbyte of RAM. There is also a socket for a maths co-processor if required. Mac-286 is said to support the MDA and CGA display standards and Hercules graphics.

The Mac-286 is expected to be formally launched in August. The retail price has not yet been fixed, although it is expected to be in the region of \$1,500.

A similar board for the Macintosh SE is due to become available in September. Called the Mac-86, it features an 8086

processor running at 8MHz. No memory is fitted to the card as it shares main memory with the 68000 processor. The card is tentatively priced at \$599.

The third expansion system in the range is the AST-ICP, a communication processor which takes over many of the I/O tasks from the CPU. The ICP board holds 512K of RAM and supports up to four serial ports. It is envisaged as providing a gateway to multi-user processes on the Macintosh II running under Unix.

The final announcement is of the AST RM-4 card. It can supply up to 4Mbyte of RAM for the Macintosh II fitted as 256Kbit DRAMs with 150ns. access time. The RM-4 comes with memory in four 1Mbyte increments. Prices range from \$899 for the 1Mbyte version to \$1,799 for the 4Mbyte model.

Details from AST Europe, AST House, Goat Wharf, Brentford, Middlesex TW8 0BA. Telephone: 01-568 4350.

Network specialists provide X-25 link

NOVELL and Torus INL have announced new X-25 bridging products.

There are two products from Novell. The Netware Remote Bridge X-25 is used to connect up to 32 netware LANs via an X-25 network which can be either public or private. The Remote Bridge X-25 will run at up to 64Kbaud.

The other new Novell product is Netware X-25 Gateway, designed to allow users on a Novell network to communicate with others on an X-25 LAN. The system can use a non-dedicated work station and, like the Remote Bridge, can operate at speeds of up to 64Kbaud. Further details are avail-

able from Novell Network Centre, 2 The Pavilions, Stoke Gardens, Slough, Berkshire SL1 3QD. Telephone: (0735) 824861.

Torus INL, the consultancy division of Torus Systems, has also launched an X-25 Gateway. The card can be installed on any IBM PC or compatible for use with a variety of Net BIOS compatible networks, including the IBM PC Broadband and Token Ring, AT&T's Starlan, and Torus's own Tapestry. Prices for the Torus INL X-25 Gateway start at £1,395.

For details contact Torus INL, Unit 32, Science Park, Milton Road, Cambridge CB4 4BH. Telephone: (0223) 862131.

HARDWARE SHORTS

- Tandy has launched the 200K capacity Portable Disc Drive 2 for its Tandy 102 and Tandy 200 machines. Further details on (0922) 477778.

- Turbomax adds a 16MHz 68000 CPU to the Macintosh, expands the memory to 2Mbyte and costs £1,195. Details from 01-965 9605.

- Fujitsu has increased the maximum number of users on its 2020 Pick-based Micro from eight to 20. Further details available from 01-573 4444.

- The Goupil Club is now being fitted with the NEC V-20 processor. For details phone 01-785 2411.

- Time Computers is offering a service where you can trade in your Amstrad PCW-8256/8512 for a PC-1512. Details on (0254) 63414.

- Olivetti has announced a round of price cuts of between 15.8 percent and 22.4 percent. This brings the cost of an entry-level M-24 to £1,426. More details on 01-785 6666.

- Unisys has introduced the B-38 work station based around the 80386 processor. More details from 01-961 2252.

Safer RAM discs

TWO companies have announced silicon-disc products which do not need to be backed up at the end of a session. The idea is to give users the speed of RAM access with the security of magnetic media.

ICCT is offering Superam as an option with its popular All Card memory expansion board. Superam uses battery backing for up to 8Mbyte of RAM. Prices start at £595. Details can be obtained from ICCT, 2nd Floor, Worcester House, Vintners Place, Upper Thames Street, London EC4V 3AU. Telephone: 01-248 8895.

Battery-backed RAM is fine until the battery runs out and destroys your data. XCalibur claims to have solved this problem with Rombo. This plug-in card contains up to six EPROMs. Each Rombo can hold up to 360K of data and costs £250.

Details from XCalibur Computers, Kent House, 30 Billing Road, Northampton NN1 5DQ. Telephone: (0604) 259211. 

Interquadram improves display

INTERQUADRAM has introduced a new video-display adaptor called the Quad EGA Prosync, which will display up to 120 columns of a Lotus spreadsheet. If used with version 2.0 of Lotus 1-2-3 it will display 120 columns by 43 rows.

It is claimed that the card supports all the usual IBM standards of MDA, CGA and EGA, as well as the Hercules Graphics Card. The card also adds two extra modes of its own: 640 by 480 pixels and 752 by 410 pixels.

For these high-resolution displays you need a multi-sync monitor.

The Quad EGA Prosync costs £349 and is supplied by Interquadram, 653 Ajax Avenue, Slough, Berkshire SL1 4BG. Telephone: (0753) 34421.

ABC

The Business Solution

NOW!
3 1/4 & 5 1/2
Disks
available

THE ONLY ONE THAT DOES IT ALL!

FOR IBM PC & COMPATIBLES

The Programme that helps you run your own business.

- **TYPING & WORDPROCESSING**
word processing for business letters, quotations, etc; with mail-merge and calculations.
- **FILING**
card-index database; multi-index; with report generator and label print routines.
- **BOOK-KEEPING**
incorporates INVOICING, SALES PURCHASE, NOMINAL and CASHBOOK. Prints Statements, Daybooks, Audit Lists, Remittance Advice, VAT Return, Profit/Loss and Balance Sheet. Bank managers and Accountants like the simple but foolproof double-entry system. Approx Capacities.
- **STOCK CONTROL**
Linked to Sales Invoicing. Keep records of stock history and movements. Ideal for valuation reports and controlling stock levels.
- **CALC-SHEET**
Mathematical operations; percentage calculating and replication of functions are all performed on this easy to use 26 x 60 spread sheet calculator, ideal for Cashplan forecast, Costing and "What If" calculating.
- **GENERAL**
Electronic Notepads, Phonebook, Diary and Alarm Calls, Backup routine, Printing Calculator, Access to MSDOS within program, Links to DESKTOP PUBLISHING Packages, User definable Printer Definitions, Screen Colours, Help Screens, Passwords.
- **AFTER-SALES**
User Club with telephones Help-Line, and Newsletter full of hints and tips.
- **OPERATION**
A-B-C is completely Menu driven, with many Help Screens, making it ideal for beginners. However, experts will find there are many shortcuts and powerful "hidden" features for when you want to go faster.

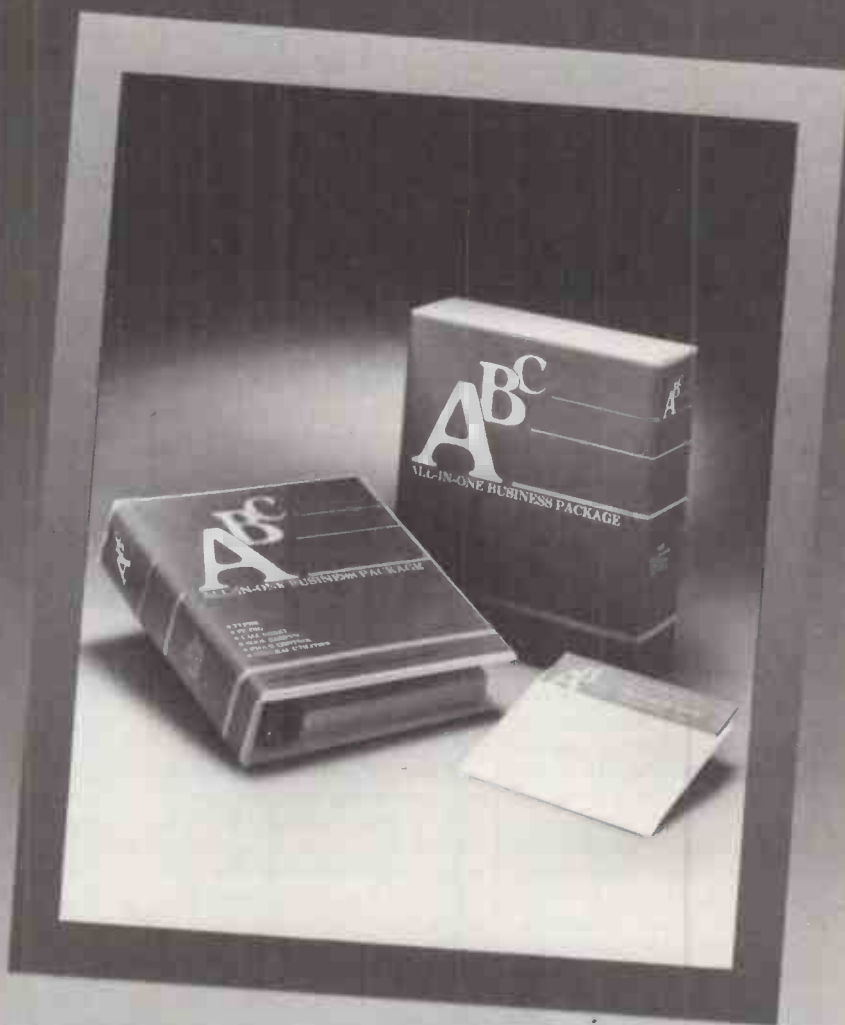

*As recommended by the Press
"...the only package you will need".*

ONLY £150 plus VAT

A-B-C SYSTEMS LTD,
Regent House, 188 High Street, Sutton, Surrey, SM1 1HH.
Telephone: 01-661 0488 Tele Gold 265871 MONREF G/MAG70113

Available from:-
Softsel, Centresoft, Precision, Screens Micro Computers,
and all leading distributors.

Leonardo knowledge program

UNLIKE most expert-system shells, Leonardo lets you get started without spending a fortune. It comes in three versions costing £149, £695 and £1,995. The cheapest puts a limit of 1,000 lines on your rule base, but this should still be enough to allow development of quite complex systems. The next version up removes this restriction, while the top-line product has extra features aimed at professional knowledge engineers.

Expert-system shells are used for capturing human expertise on a computer, where it can be put to use on demand.

For further details contact Creative Logic, Brunel Science Park, Kingston Lane, Uxbridge, Middlesex UB8 3PQ. Tel: (0895) 70091.

Macintosh print utilities

TWO new print-spooling programs are now available for the Mac. Laserserve, which costs £109, works with the Laserwriter and other network printers. Printworks for the Mac costs £69 and works with dot-matrix printers. Printworks also lets you produce colour graphics from many popular Macintosh packages when used with an Imagewriter II.

Both programs are available from P&P Micro Distributors, Todd Hall Road, Carrs Industrial Estate, Haslingden, Rossendale, Lancashire BB4 5HU. Telephone: (0706) 217744.

LOTUS TEAMS UP WITH IBM

LOTUS is set to enter the database market with its own range of high-end products, and has also signed a collaborative deal with IBM for the development of software for both personal computers and mainframes. Lotus is also expected to make clear how it intends to adapt to the new world of OS/2.

The new database products will arrive with the full version of OS/2 next year. Several products appear to be involved, but Lotus is targeting the multi-user departmental database running on a network as the key area. This or other database products are likely to be SQL compatible and to offer good links through to databases running on larger systems.

In early 1988, IBM will start distributing 1-2-3/M, a mainframe version of Lotus's best-selling spreadsheet program. This product is the first fruit of a wide-ranging agreement between Lotus

and IBM which covers both development and marketing. 1-2-3/M will run under VM and MVS, the two leading operating systems on IBM System/370 computers. Lotus and IBM will also jointly explore PC database applications that are compatible with SQL.

Lotus plans to release two new PC versions of 1-2-3. Lotus 1-2-3/G is a graphics-based product designed to take full advantage of the OS/2 Presentation Manager. It is expected sometime next year. Lotus 1-2-3 release 3 is character-based, like the existing product. It will run under OS/2, but does not require it, working with MS-DOS as well. Expected availability is early 1988.

For more details contact Lotus Development, Consort House, Victoria Street, Windsor, Berkshire SL4 1EX. Telephone: (0753) 840281.

Word Perfect for the Macintosh

WORD PERFECT is coming out on the Mac. It is scheduled to go on sale in the U.K. in the third quarter of 1987, with a likely price of around £375.

Word Perfect is the best-selling word-processing program worldwide on IBM-compatible kit. It is likely to prove a strong competitor to Microsoft Word on the Mac, and other full-feature programs like Write Now.

The Mac version will contain the same kind of thesaurus and

spelling-checker features which are strong points of the original IBM product, and powerful list management and mail-merge facilities. The package is particularly suited for long documents; footnotes, end notes, indexing and automatic table of contents generation are all supported.

Contact Sentinel Software, Wellington House, New Zealand Avenue, Walton-on-Thames, Surrey KT12 1PY. Telephone: (0932) 231164.

The software clones bounce back

FOLLOWING some favourable legal developments in the United States — as reported on page 17 of this issue, for example — activity has returned to the clone software market. New versions of Mirror and of VP-Planner are now shipping, and the The Twin has a new U.K. distributor.

Lotus's case against Twin's maker Mosaic software seems to have received a setback with a U.S. court ruling that there is no case to answer over screen copyright. At the same time Lotus itself has become the target for a legal action by Software Arts Products, alleging violation of VisiCalc copy-

right during the original development of Lotus 1-2-3.

Twin is a 1-2-3 look-alike spreadsheet with better graphics. It costs £70 in the U.K. from its new distributor, Ctrl Alt Deli, 44 Brownbaker Court, Neath Hill, Milton Keynes MK14 6JH. Telephone: (0908) 662759.

VP-Planner is another top-rated 1-2-3 clone and sometime target of Lotus legal action. Additions to release 1.35 of VP-Planner include password protection and the ability to read Symphony files directly. The program costs £99 including VAT from Newstar Software, 200 North Service Road,

Brentwood, Essex CM14 4SG. Telephone: (0277) 220573.

Software Arts Products' action concerns the early days of 1-2-3. The first spreadsheet to take the market by storm was Software Arts' VisiCalc, which made a name for itself on the Apple II long before the arrival of the IBM PC or Lotus 1-2-3.

Software Arts Products' allegations against Mitch Kapor, co-founder of Lotus, are therefore potentially very damaging to Lotus's reputation as upright defender of the concept of "look and feel" copyright in software. Lotus strenuously denies the claim.

SOFTWARE SHORTS

● Adobe, the firm behind the Postscript language used by many top-end laser printers, has come out with its own drawing package. Adobe Illustrator runs on the Mac and is aimed primarily at graphic artists and technical illustrators. It is going on sale immediately at £450. Contact McQueen on 031-558 3333.

● Dac Easy Word II is a low-cost word processor. For £49.95 you get the ability to view four documents at a time and cut and paste between them, to mail-merge and to check spelling. Contact TSL on (0483) 898140.

● Letrix Junior is a cut-down version of Ideal's well-known print enhancer aimed at the Amstrad PC. Priced at £49.95, it gives you seven NLQ founts from any of the common nine-pin matrix printers, including the Epson and Amstrad ranges. The full version at £99.95 gives you 20 founts. Ring 01-390 6722 for further details.

● Answer/DB now supports IBM's DB-2 mainframe database; it already supports IMS. Answer/DB consists of matching micro and mainframe software running under MVS or DOS/VSE at the mainframe end. It is used to selectively extract and download mainframe information to the micros. Prices typically start at around £25,000. Contact Sterling Software on 01-242 0770.

Autocad family enhanced

THE LATEST version of Autocad has major enhancements to its three-dimensional solid modelling capability. The price of version 2.6 of the brand-leading drafting package remains unchanged at £2,500.

Autodesk has also announced AEC Architectural, a £1,000 optional extension to Autocad aimed at architects. Autoshade, a new £500 package, lets you add three-dimensional shading and colour to Autocad drawings. These two products will be available later in the year.

Contact Autodesk, 90 London Road, London SE1 6LN. Telephone: 01-928 7868. 



He's made the right decision. So can you.

It's not easy choosing a printer. So many to choose from, so many different features.

But more and more companies are discovering that after looking at the Star printer range there is no doubt as to the right choice. Take the low-cost NX-15 for example.

Fully IBM compatible, the NX-15 offers proportional spacing as standard in both NLQ and draft modes, making it ideal for word processing as well as spreadsheets and listings.

With a capable 120 CPS in draft mode or 30 CPS in near letter quality mode, you won't be kept waiting for your copies.

Every function you'd normally use is on a single touch panel on the front of the printer. You can even forget the days of fiddling with little dip switches.

Add to that the fact tractor and single sheet feed are fitted as standard and you'll see you're looking at a star performer.

All Star printers are supported through a nationwide dealer network backed-up by the finest distributors in the business, so you're never on your own.

Discover the Star printer range today.

Fill in the coupon or just 'phone Belinda on 01-840 1829 for more information.

It'll be one decision you certainly won't regret.

the right decision

Star is making it easier to choose the right printer when it comes to service and backup. Our pedigree is inherited from many years in the manufacture of precision machine parts and a long history of producing computer printers. This means you can rely on Star's wealth of experience in advanced design and manufacturing.

Countless users have made the right decision - why not join them?

Star Micronics U.K. Ltd.
Craven House,
40 Uxbridge Road,
Ealing, London W5 2BS.
Telephone: 01-840 1800.
Star Micronics Co., Ltd., Japan.

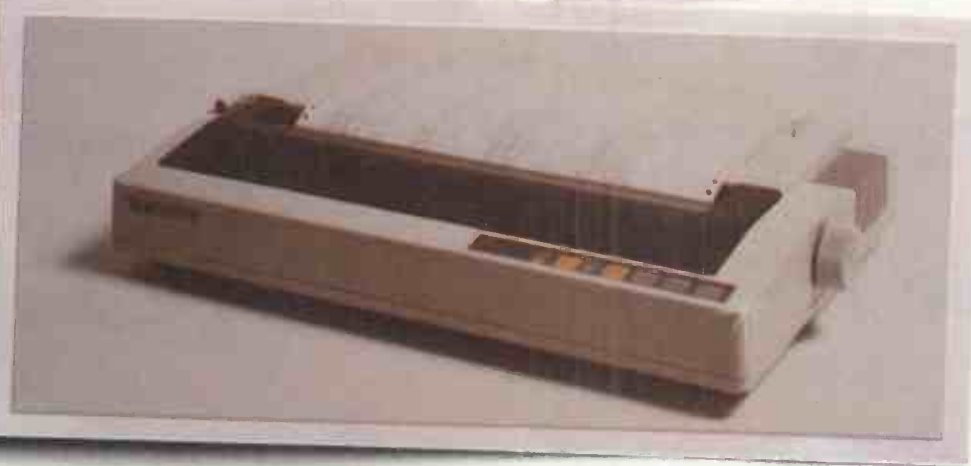
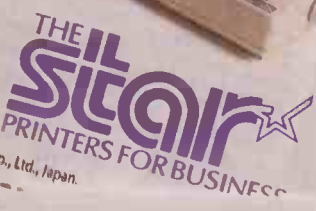

I would like to be sure I'm making the right decision. Please send me details on the Star range of printers.

Name _____

Company _____

Address _____

Postcode _____

Telephone _____



Or just call Belinda on 01-840 1829.

Star Micronics U.K. Ltd.
Craven House,
40 Uxbridge Road,
Ealing, London W5 2BS.
Telephone: 01-840 1800.



A division of Star Micronics Co., Ltd., Japan.

→ circle 134 on enquiry card ←



8 MHz

512KB RAM

6 free option slots

30 Mb

Decisions,



6, 8 or 10 MHz

640KB RAM

7 free option slots

20-80 Mb in 4 models

decisions.

When it comes to choosing a fast and powerful IBM AT compatible computer we at Epson see no contest.

Because when you compare our new PC AX computer with our opposite number at IBM, you'll see that ours is superior on a number of very important counts.

But that's only half the story — because the PC AX matches the IBM AT on all other points, too.

All, in fact, except one. Ours works out a lot less expensive.

In other words, we think you'll agree that the new Epson PC AX wins hands down. And you don't need a computer to work that out.

For further information on the PCAX either write to Epson (UK) Limited, Freepost, Birmingham, B37 5BR; call up Prestel *280#; or dial 0800 289622 free of charge.

EPSON

→ circle 135 on enquiry card ←

Ferranti competition results

THE winners of the competition published in February's *Practical Computing* are Richard Munday and James Hawkins. Mr Munday gets the first prize of a Ferranti XT with a 20Mbyte hard disc plus monitor, graphics card and software. Mr Hawkins' second prize is identical except that the XT is fitted with twin floppy discs.

Entrants had to guess the identity of the 10 famous computing personalities pictured. Listed from 1 to 10 they were Bill Gates, Ben Rosen, Jack Tramiel, Gary Kildall, Ken Thompson, Alan Sugar, Roger Foster, Chuck Peddle, Sir Clive Sinclair and Iann Barron. Numerous entrants managed to put the right names to the right faces, so the winners were chosen because of the tie-breaker, in which they were asked to suggest which individual had contributed most to the world of computers.

We would like to thank all those who entered the competition, and Ferranti Computer Systems for generously providing the prizes.

PROFITS RISE AGAIN

MOST major companies are claiming record sales and profits for the first calendar quarter of 1987, but IBM's profits have taken a tumble. The company's profits for the period were \$785 million — a 23 percent decline from the figure of \$1.02 billion for the equivalent quarter last year — despite the fact that sales rose to \$6.5 billion. The conclusion is that IBM's profit margins, which are traditionally much greater than its rivals', have been squeezed by increased competition.

For many other companies the picture looks a lot rosier. Compaq

increased its net income by 142 percent to \$20.2 million. Sales for the company's products increased by 47 percent to \$211 million. The company attributed the sales growth to the new range of machines like the Portable III and Deskpro 386.

Apple too has reported a surge in sales. The company says that revenue for the quarter reached \$573.3 million, an increase of \$166.4 million over last year. Net income totalled \$33.9 million. The relatively poor income to sales figures is claimed to be the result of high research spending by the

company, which has increased 43 percent over the last year.

Elsewhere, Zenith Data produced a loss of \$10 million although sales were up 16 percent. Newly formed Unisys also lost money — a total of \$91.8 million — much of it due to the cost of the merger of Burroughs and Sperry in which the company was formed.

Novell's sales rose by 106 percent with net income rising 71 percent over the year to just over \$3.5 million. Motorola's sales increased by 15 percent to \$1.55 billion, with profits rising to \$56 million.

BBC's apology is accepted by Amstrad

THE BBC has unreservedly apologised for statements contained in the 25 March issue of its house magazine, *Ariel*, over allegations concerning the electrical safety of the Amstrad PC-1512, and that it had been rejected by British Aerospace and "at least one university". Both British Aerospace and the university allegedly concerned have

written to Amstrad dissociating themselves from the article.

Alan Sugar is quoted as saying: "We are satisfied that the BBC apology is unequivocal and humble. We will not be pursuing our libel action against the Corporation." But the company says that it is contemplating pursuing claims against several publications which repeated the allegations.

Unlock utility withdrawn

FOLLOWING discussions with Lotus, Trisoft has agreed to cease distribution of the programs Unlock Album A and Unlock Album D. The programs are used to circumvent the copy protection on Lotus's 1-2-3 and Symphony products. Lotus also says that it will take any necessary steps to prevent the Unlock packages and similar software from being distributed in the U.K.

Thanks for making things diff



Mirror wins first round in court

SOFTKLONE INC. has effectively fought off a lawsuit by Crosstalk, who alleged that Softklone's Mirror communications package infringed Crosstalk's copyright. A court in Tallahassee, Florida ruled that only one screen out of 125 infringed copyright. Softklone says it will be making alterations to this screen.

Judge O'Kelley found that the Mirror program was acceptable in itself, although he laid down guidelines as to what changes will be required to the offending status screen. Softklone intends to appeal over the judgment, while making the required alterations to Mirror's status screen.

U.K. distributor of Mirror, Management Data Processing Ltd, is now to begin shipping Mirror II for sale in this country. For more details contact Management Data Processing, 37 Great Pulteney Street, Bath, Avon BA2 4DA. Telephone: (0225) 60491.

Superconductor race warming up

IBM has claimed to have made significant gains in the science of superconductors — materials which lose all electrical resistance when cooled to sufficiently low temperatures. It is thought that superconductors will be important in the manufacture of very high-speed super-computers.

Workers at IBM's Thomas J Watson research centre in the United States have created a thin-film device which superconducts at -205° Celsius. IBM has dubbed this device a Superconducting Quantum Interference Device or Squid. The properties of the compound from which the Squid is made mean that it is highly

sensitive to changes in magnetic fields.

Just as important from the practical viewpoint is that the new devices can be made to superconduct at around the temperature of liquid nitrogen, which is relatively cheap and easy to manufacture. Previously, superconducting devices had to use the more expensive liquid helium.

The breakthrough originally came from IBM's Zurich laboratory, where two of IBM's engineers created a superconducting substance made of lanthanum, barium, copper and oxygen which functioned at a temperature of -243°C.

SHORTS

- Amstrad has won a contract for 2,250 PC-1512s from the Open University which will form part of a rental pool for students.
- The Extel Group has sold Digital Microsystems to Apricot for £2 million. Details on 021-456 1234.
- Tandy U.K. is offering free registration to Telecom Gold on a range of its business and portable computers. Phone (0922) 477778.
- The Data Protection Registrar is consulting with representatives of small businesses to assist them with registration under the Data Protection Act. Further information from (0625) 535777.

PCC takes over Bristol assets

CLONE maker Personal Computer Compatible has acquired some of the assets of Bristol Micro Traders, another clone manufacturer, which went into liquidation in February. PCC has taken over the customer lists and outstanding orders, and has offered those con-

cerned special rates on its own range of clone machines.

PCC's managing director, Alexander Heal, has said: "We are doing everything possible to ensure that BMT customers are not left stranded. We cannot, however, help people who have

paid for machines in advance and have not received the product."

Further information is available from Personal Computer Compatible Limited, Mayo House, Mayo Road, Walton-on-Thames, Surrey KT12 2QA. Telephone: (0923) 231199. 

cult for us,



we appreciate it.

Which means we're on the move. A big 'thank you' to all our customers, to the thousands of companies who use our rental services. You've made us outgrow 'The Rental Centre' in Teddington much quicker than planned. We moved there in the Summer of '84 and we're staying in Teddington. But now our new home is in the bigger and better hi-tech "Livingston House" in Queens Road. The 'Helpline' telephone number to Europe's No. 1 in electronic equipment rental remains the same. For the product you need from the best rental service in the business it's still 01-977 8866. **Thanks again.**

 Livingston Hire
01-977 8866

Livingston House, The Rental Centre, 2-6 Queens Road,
Teddington, Middlesex TW11 0LB.

NORTHERN Tel: 061-998 7900

SCOTTISH Tel: 0506 415757

FREE SOFTWARE?

SPECIAL SELECTIONS FROM THE PUBLIC DOMAIN (0344) 86 3020

Well, almost free. We don't charge for the public domain and user supported software but there is a small service charge from £6 per disk to cover promotion costs, selection, testing, copying, etc. We have disks for MS-DOS and CP/M. Mail and telephone order only.

Out of the thousands of programmes we have collected, we bring you a SELECTION OF THE BEST that have been carefully tested and documented. They'll run on a wide variety of computers that will accept 5 1/4" disks.

MS-DOS programmes are intended for the IBM-PC and close compatibles. Documentation is included on the disks, where required.

MS-DOS

Disk No. GAMES

M1: SPECIAL COLLECTION. A graphic, intelligent adventure, a space trek and a surprise called Bouncing Baby.

M3: ORIGINAL ADVENTURE. The original classic in C, with source.

M4: SELECTED BASIC GAMES. More than 20 games, including Blackjack, Catch88, Eliza, Meteor, and Pacman.

M5: SUPER COMPILED GAMES (1) Eight very good arcade games, including Pango, Gold, Pyramid, 3-Demon, etc.

M6: CHESS. Several extensive versions of this well-written game. Has graphics.

M8: SELECTED FAMILY FUN GAMES. 2 Flight Simulators, Music Generator, excellent Pacgirl, Space Wars, etc.

M11: MONOPOLY. Several excellent computer versions of this popular board game.

M13: DUNGEONS & DRAGONS. Cave Quest - a very good adventure game. If you like monsters and magic this is for you.

M17: PINBALL GAMES. Contains three fascinating games of varying degrees of difficulty. Engrossing.

M1022: SUPER COMPILED GAMES (3). Arcade type games. Includes Kong, Striker, Spavevade, Life2 and Frog.

M1023: GREAT BASIC GAMES. Over a dozen, including Wizard, Xwing, Combat, Mars, Racecar, CIA. Requires Basic.

M1037: POOLS AND LOTTO. Choose your numbers and the game does the rest.

M1038: TAROT AND I CHING. A choice Aussie contribution. Reads your "cards" or "throws" coins or yarrow sticks.

M1039: JOKES AND INSULTS. Harmless practical jokes on computer users. Also surprises with insults on screen.

M1040: YACHT RACE SIMULATION. Interactive, extensive and fascinating. Based on America's Cup match racing.

UTILITIES

M26: UTILITIES FOR PERSONAL MANAGEMENT. Similar to Sidekick, with calculator, notepad/editor, phone index, alarm clock, calendar, printer controls, etc.

M27+: UNPROTECTION METHODS. Hints and programmes that help you to back-up a variety of copy-protected programmes. 3 disk set for £24.

M32: DISK DOCTOR COLLECTION. Excellent debugging and file repair programmes. Includes Jaz, Easy-Zap, Diskit, etc.

M33: HARD DISK UTILITIES. Special set of dozens of highly useful utilities for greater efficiency.

M34: MULTI-TASKING SHELLS. Two excellent DOS Shells which allow you to operate and execute from a menu-system - Dosomatic and Still River Shell. Interrupt tasks and switch to other programmes.

M35: CP/M EMULATION. Run CP/M software on your PC. Well-documented and source coding is provided.

M2030: SYSTEM SNOOPER. Has device drivers, utility tutorials, marks bad blocks, diagnostics, redirects output, etc.

M2031: STRATFORD UTILITIES. Has demon for backing-up some difficult programmes, replaces joystick commands with cursor control and more.

M2032: NANOVISION UTILITIES. Converts text files to com files for self-display; memory-resident page; visual file deletion. More.

M2033: SELECTED MENU SYSTEM. Menus are created with word processor. 10 options per menu; sub-menus, etc. Makes usage friendlier.

M2034: MULTIPLE FILE CATALOGUER. Catalogues for word processing, databases, games, etc. Searches, sorts, prints reports and directories.

M2035: MORE HARD DISK UTILITIES. A super collection for optimising disk usage. Well worth having.

M2036: PC SPEED-UP. Inexpensive way of getting more out of your hardware. Diagrams need Epson-compatible printer.

M2037: MANAGING MEMORY-RESIDENT UTILITIES. Organise and control memory better.

WORD PROCESSING

M42: TYPING TUTOR. Improve your keyboard work. Menu-driven, easy to use.

M43: MULTI-FONT WRITER. On-screen scientific notation. Greek letters, gothic, bold, italics, etc. Recommended.

M48: OUTLINER FOR WORD PROCESSING. Considered by many to be the best outliner/ideas processor available.

M49: FORM LETTERS. Examples of the most commonly-used business letters - dozens of them.

M3014: SIDEWRITER. Generates printed output sideways to fit wide reports on a page.

M3019: PROGRAMMERS EDITOR for source code editing in structured languages. can be memory-resident. Built-in doc.

GRAPHICS

M61: GRAPHICS. Some of the best programmes, including picture-graphics set of commercial standard.

M62: SLIDE PRESENTATION. Prepare transparencies for overhead slides.

M66: EXTENDED FONT CHARACTERS - A utility for Epson-compatible printers that will print all of the printable characters of MS-DOS character set.

M67+: COMPUTER-AIDED DESIGN. Powerful control over drawing, graphics, printing, and slide show. Two-disk set £18. Requires colour monitor.

LANGUAGES

M85: PASCAL. A popular language for general programming. Good choice for learning to programme.

M94+: ARTIFICIAL INTELLIGENCE. These 2 disks contain TWO expert system shells - Esie and Expert. £18. They help you gather information and make a recommendation.

M95+: BASIC LANGUAGE. Interpreter with manual. 2 disks. £18.

COMMUNICATIONS

M101: TWO MAJOR COMMUNICATIONS programmes - Qmodem and Kermit. Lots of bells and whistles.

M6010: PROCOMM. Many featured programme for contacting bulletin boards.

M6012: UK BULLETIN BOARDS. A comprehensive listing of bulletin boards in UK. M107 is an Australian listing.

BUSINESS/CALCULATION

M121: GENERAL LEDGER ACCOUNTING. A small-business recording system. Highly regarded. Excellent reports.

M124: STOCK MARKET ANALYSIS. Special aids to help you "think and grow rich". For managing and evaluating portfolios and prospects.

M125: GOAL/TIME MANAGEMENT. For goal-directed organisation. Arranges information, prompts action.

M126: STATISTICAL ANALYSIS. Many programmes in Basic for analysis - Chi, Regression, Fisher, Binomial, Variance, Histogram, Poisson, Correlation, etc.

M127: SPREADSHEET. Easily used, comprehensive programme.

M128+: INTEGRATED PACKAGE. Three disks. Includes integrated word processor/spreadsheet/database/graphics. £24.

M129: 1-2-3 UTILITIES. Highly regarded collection of utilities that enhance the operations of Lotus 1-2-3.

M132+: 1-2-3 WORKSHEETS. Comprehensive special set of worksheets, aids and utilities. £54 for 8 disks. (Does not include M129.)

M136: PROJECT MANAGEMENT. Will handle 1000 tasks and does critical path analysis, cash flow, bar charts, cost reports, etc.

M137: STOCK CHARTING SYSTEM. Records highs, lows, volumes, prices, etc. In Basic.

M7029: INTEGRATED ACCOUNTING. General Ledger, Cash Book, Debtors, Payroll, etc - all on one disk.

M7030: CALCULATORS' COLLECTION. Calculations for various occasions - programming, school, finance, many digits, etc.

M7031: PERSONAL FINANCE MANAGER. Manages cheque and credit card a/cs, savings, purchases, withdrawals, interest, budgets.

DATABASE MANAGEMENT

M142+: DBASEII/III APPLICATIONS. Extensive group including: cheque payments, mail management, inventory ctl, budgeting, accounting, depreciation, general ledger, graphics, etc. 5 disk set £36.

M143+: FAMILY TREE/GENEALOGY. Recording, tracing, grouping, printing family tree. In Basic. 2 disks with documentat. £18.

M147: DBASEIII SCREEN CODE GENERATOR. Greatly reduces the amount of programming you need to do. Generates coding to include in your own programme.

M150+: DATA BASE MANAGER. Suits sales/stocks/mailling/personnel/payroll. Calculates, prints invoices etc. 2 disks £18. Has full documentation.

M151: MAILING LIST MANAGER. You can add, edit, sort, and print mailing labels for all members or selected groups.

M152+: RBASE LOOKALIKE. Operates as standalone system in menu and command modes or will drive application programmes. 3 disks. £24. Requires hard disk.

M8012: LABEL PRINTING. Collection that allows you to print labels for all sorts of uses, as well as control mailing lists.

M8013: FREE FILE. Menu-driven, easy to use relational data base that allows 100 fields and up to 2 billion records.

M8015: RETAIL INVENTORY. Menu-driven, very fast system for keeping inventories up to date.

M8017: PRODUCTION DATABASE. Keeps track of suppliers, materials requirements, product costs, etc.

EDUCATION

M201: BASIC TUTORIAL. How to programme in Basic. Onscreen demonstration and explanation.

M203: MATHS TUTOR. A Basic programme that suits primary classes. Has six grades of arithmetic training.

M204: PC-TUTOR. Learn more about the operation of your computer, the important commands, etc.

M9007: SECONDARY MATHEMATICS. Collection of Basic programmes that provide instruction in key areas.

M9015: FOREIGN LANGUAGES TUTORIAL. Has instruction for French, German, Italian, Spanish and Hebrew.

M9016: LOTUS 1-2-3 TUTORIAL. Advanced techniques when developing spreadsheet skills.

M9017: DOS TIPS AND HINTS. Collection of advice on printing, screen, keyboard, colour, batching, booting, AT keyboard, etc.

GENERAL

M9501: DIETER'S FRIEND. Nutritional analysis programme compares your intake.

M9502: SPORTING ADMINISTRATION. Helps run events, match opponents, report results.

M9503+: BIBLICAL QUOTES. 14,800 cross-references to 7956 verses of new testament for talks, sermons, essays. £18.

SHAREWARE REQUIRED FOR INTERNATIONAL DISTRIBUTION

We have extensive marketing and distribution facilities locally and overseas and require quality software for international distribution. Adequate documentation should be on the disk. Please forward submissions to our Chief Executive at the address below.

CP/M

Call or write for free catalogue.

PUBLIC DOMAIN NEWSLETTER

For news, reviews, views and how to use public domain and user-supported software subscribe to our bi-monthly newsletter and keep informed on the free programmes that help your computer to serve you. Only £12 per annum. (VAT not apply.)

ORDERS:

The first disk costs £10, the second £8 and each disk thereafter is £6. The price of sets is specified in adv. Add £2 post/pack and 15% VAT to total. Orders outside U.K. post/pack £3 (no VAT). ORDERS MUST BE PREPAID.

PAYMENT BY MAIL TO: SELTEC COMPUTER PRODUCTS LTD, "Farley Hall", Wokingham Road, Bracknell, Berkshire RG12 5EU

TELEPHONE ORDERS: (0344) 86 3020 (0344) 56 029
Pay by Mastercard or Visa.

We cannot guarantee the suitability of public domain/user-supported software for users' needs or equipment.

PC PROGRAMMES FOR ONLY £2!

From the thousands of programmes we have collected from public domain and user-supported software we bring you a special selection of the best utilities available - special purpose programmes that you may choose in any combination that you wish.

Choose one number for only £2 each (service charge), with a minimum of six programmes, and we transfer them on to one (or more) of our disks for you.

We include source coding where possible. The programmes are documented, where required. Disks are formatted for MS-DOS 2.0 or greater. 360 k. Programmes are intended for the IBM-PC or close compatibles.

EFFICIENCY WITH FILES AND COMMANDS

- U1. DIRECTORY CONTROL.** Returns you to a previous directory whose name it saves.
- U2. RAMDISK.** Very good ramdisk creator - like a memory-resident disk drive.
- U3. WINDOW TOOLS.** Mini Sidekick with memory-resident editor, timer, ASCII reference.
- U4. FAST DISK.** Speeds up activity and processing of many programmes.
- U5. FILE MANAGER.** Excellent general purpose file manager that copies, deletes, views, etc. Many features.
- U6. DIRECTORY LISTER.** Creates directory lists for comments. Saves to disk.
- U7. DIRECTORY PATHS.** Lets programmes write to other directories.
- U8. KEYBOARD DEFINER.** Redefines keyboard to suit own needs.
- U9. SPACE.** Shows the amount of free space on disk in thermometer style.
- U10. SUPERIOR DIRECTORY.** Shows disk directory with file attributes which are active. Also sorts by name, date, size, extension. Accurate for hard disk.
- U11. BACKED UP.** Indicates which hard disk files have not been backed-up.
- U12. NEW FILES.** Lists files that you created today.
- U13. SPEEDKEY.** Increase speed of cursor.

FILE PRINTING/EDITING

- U101. PRINTER SWAP.** Swaps line printer assignments for easier printing.
- U102. WORDSTAR CONVERTER.** Superior converter of wordstar to ASCII and reverse from document file.
- U103. DISK COVER DIRECTORY.** Prints directory in size suitable for pasting on disk jacket.
- U104. COMMAND EDITOR.** Very good editor of operating system commands.
- U105. BANNER.** Prints wide banners on your printer.
- U106. LISTER.** Prints documentation, adding page numbers.

- U107. PRINT CONTROLLER.** Gives extensive control of printer settings - bold, italics, compressed, etc. Epson compatible.
- U108. NOT PRINT.** Redirects computer output to the screen.
- U109. DARKEN.** Overstrikes a text file to obtain darker print.
- U110. MERGE.** Merge sorted files into one sorted file.
- U111. TEXT FORMATTER.** Processes text files for printing with special features imbedded in output - bold, italics, etc.
- U112. SEARCH/REPLACE.** Search for and replace characters.
- U113. CUT & PASTE.** Allows movement of parts of documents between files.
- U113. NOTEPAD.** Ready at hand notepad. Memory resident.
- U114. TEXT INDEX.** Indexing for text files. Mark words for listing.
- U115. WORDSTAR INDEX.** Indexing system for Wordstar.
- U116. UNDERLINE STRIPPER.** Strip underline from Wordstar files.
- U117. KEYBOARD DEFINER.** Keyboard redefiner for Wordstar.
- U118. WORDSTAR COLOUR.** Adds colour to Wordstar.
- U119. WORDSTAR NUMBERS.** Add and remove numbers to paragraphs in Wordstar files.
- U120. WORDSTAR CHARACTERS.** Character look-up programme.
- U121. EXECUTABLE PATCHES.** Standalone Wordstar patches.
- U122. WORDSTAR GREEK.** Obtain Greek characters in Wordstar documents.
- U123. PROGRAMME EDITOR.** Editor for programmers, with multiple windows.
- U124. TEXT EDITOR.** Editor with major commands, without frills.
- U125. LAST LINES.** Types the last specified number of lines in a file.
- U126. FAST LISTING.** Fast listing of files by extension.
- U127. SQUEEZE LIST.** Lists squeezed library files.
- U128. COUNT.** Counts characters, words, lines, pages in a textfile.
- U129. PRINTER PATCHES.** Extensive collection of printer patches for wordstar.

FILE LOCATING

- U201. SMALL FILE FINDER.** Locates files in subdirectories. Small tightly coded.
- U203. FILE SEARCH.** Memory-resident. Locates files in subdirectories.
- U204. CHARACTER SEARCH.** Searches disk for character or string.
- U205. FILE FINDER.** Locates and lists files, allows deletion of unwanted files. Act from within programme.
- U206. NEW GREP.** Matches file patterns. Has 'C' source.

FILE READING/DISPLAY

- U301. TEXT READER.** Excellent text display utility with many features. Scrolls, reads one page at time, goes to end, beginning, etc.
- U302. READ SQUEEZE.** Read squeezed files without physically un-squeezing.

- U303. READ BACKUPS.** Read backup disks of your hard disk. Needs Basic.
- U304. TREE DIRECTORY.** Displays a tree directory of files, including sub-directories.
- U305. TRACK READER.** Reads sectors and tracks in hex and ASCII.
- U306. BROWSE.** Examine files with 4 way scrolling.
- U307. DUMP.** Gives an ASCII/HEX display of any file.
- U308. DIRECTORY READER.** Read a directory from or to a certain point.
- U309. KEYBOARD BUFFER.** Keyboard buffer of 160 characters.
- U310. SYSTEM SHELL.** Operating system shell that interfaces with Crosstalk, 1-2-3, and Multimate.

EQUIPMENT HANDLING

- U401. DRIVE CLEANER.** Runs the drive for head cleaning disk.
- U402. CORELOOK.** Gives memory content in HEX and ASCII.
- U403. SCREEN SAVE.** Blanks screen if not used for several minutes. Saves screen wear.
- U404. DISKPARK.** Positions the hard disk head key for safety when travelling or moving computer.
- U405. COLOUR CONVERTER.** Displays colours as shades of grey.

FILE MOVING

- U501. SWEEP.** Famous file-handler. Reads, mass copies, deletes, etc.
- U502. REDIRECTS** output to a disk file.
- U503. NIMBLE DISK.** Helps you move more easily around a hard disk.
- U504. SECTOR RETURN.** Recovers deleted first sectors.
- U505. SELECTIVE COPYING.** Copy programme using menu system.
- U506. SELECTIVE DELETION.** Programme delete using menu system.
- U507. ENHANCED COPYING.** Copy several unrelated programmes with the same command.
- U508. NEW MOVE.** Rename and move programme to another directory without copying.
- U509. TOTAL ERASURE.** Totally erases disk, including format.
- U510. NEW DISKCOPY.** Good diskcopy with extra features. Copies whole disk. Sidesteps and signals faulty sectors.

FILE ORGANISATION AND CHECKING

- U601. ARCHIVER.** Superior file compressor and library creator.
- U602. FILE CORRUPTION.** Fast checker for detecting corrupted files.
- U603. DISK SQUEEZE/UNSQUEEZE.** Squeezes and unsqueezes all files on a disk.
- U604. PROTECT/UNPROTECT.** Avoids accidental erasure of important files.
- U605. SECRET FILES.** Make, go to, or remove a secret directory.
- U606. SQUEEZE/UNSQUEEZE.** Compresses files to save space. Also uncompresses.
- U607. LIBRARY CREATOR.** Combines files into libraries. Adds to, deletes, extracts files.

- U608. LIBRARY DISPLAY.** Displays the directory of a library. Related to above programme.
- U609. NEW NAME.** Changes volume name of a disk.
- U610. FILE COMPARISON.** Intelligent file comparison programme which detects differences between files.

SPECIAL FEATURES

- U701. CALENDAR.** Display of any month or year.
- U702. NEW DATE.** Changes date of file entry in disk directory.
- U703. BYTE CONVERTER.** Converts all bytes to 2 byte (7 bit) for serial transfer.
- U704. COMPILING AID.** Simplifies, automates compiling and linking.
- U705. ALARM.** Sets time for alarm to sound.
- U706. NEW TIME.** Sets system time and clock.
- U707. DOS HELP.** Assistance with dos commands displayed on screen.
- U708. GET TIME.** Simplifies getting time and date.
- U709. CLOCK.** Shows time on screen while you work.
- U710. CALCULATOR.** Memory-resident for convenient access.

FILE ALTERATION/RECOVERY/REPAIR

- U801. FILE RECOVERY.** Retrieves a programme you have just erased.
- U802. DEBUG TIPS.** Tips on using debugging programme effectively.
- U803. DISK PATCHER.** Reads and patches disk contents. Altering files, repairing corruptions, allowing unerase and creating files from memory.
- U804. LOCK/UNLOCK.** Protects files from unauthorised access with simple encrypting technique.

ORDERS:

The service charge for each programme is £2. There is a minimum charge of £12 (six programmes) plus £2 for postage and packaging. Add 15% VAT to total. **ORDERS MUST BE PREPAID.**

PAYMENT BY MAIL TO:
SELTEC COMPUTER PRODUCTS LTD
Farley Hall, Wokingham Rd, Bracknell,
Berkshire RG12 5EU. U.K.

TELEPHONE ORDERS:
Pay by Mastercard or Visa.
(0344) 86 3020, (0344) 56029.

We cannot guarantee the suitability of programmes for users needs or equipment.

CIRCLE NUMBERS BELOW AND SEND TO US WITH PAYMENT AND YOUR NAME AND ADDRESS. OR TELEPHONE US WITH THE PARTICULARS. SEE ABOVE.

1	2	3	4	5	6	7	8	9
10	11	12	13	101	102	103	104	105
106	107	108	109	110	111	112	113	114
115	116	117	118	119	120	121	122	123
124	125	126	127	128	129	201	202	203
204	205	206	301	302	303	304	305	306
307	308	309	310	401	402	403	404	405
501	502	503	504	505	506	507	508	509
510	601	602	603	604	605	606	607	608
609	610	701	702	703	704	705	706	707
708	709	710	801	802	803	804		

You've bought an Amstrad™ PC with a hard disc.

We can back-up your decision with the AM20 – Cristie's data protection system for the Amstrad™ PC.

If you are using your computer for business or other serious purposes, the information you have stored on it can be very valuable. Just imagine if that information were to disappear. It can happen by hard disc failure, by an accident such as fire or theft, or by simply pressing the wrong button.

The AM20 can protect you against that happening.

The AM20 is:-

- Easy to install and use;
- Compact and portable;
- Economical to share as it requires no controller card;
- Very flexible with a wealth of user options;
- Based on a tried and tested system already on sale for the IBM (TM) PC;
- Designed, manufactured and supported in the UK.

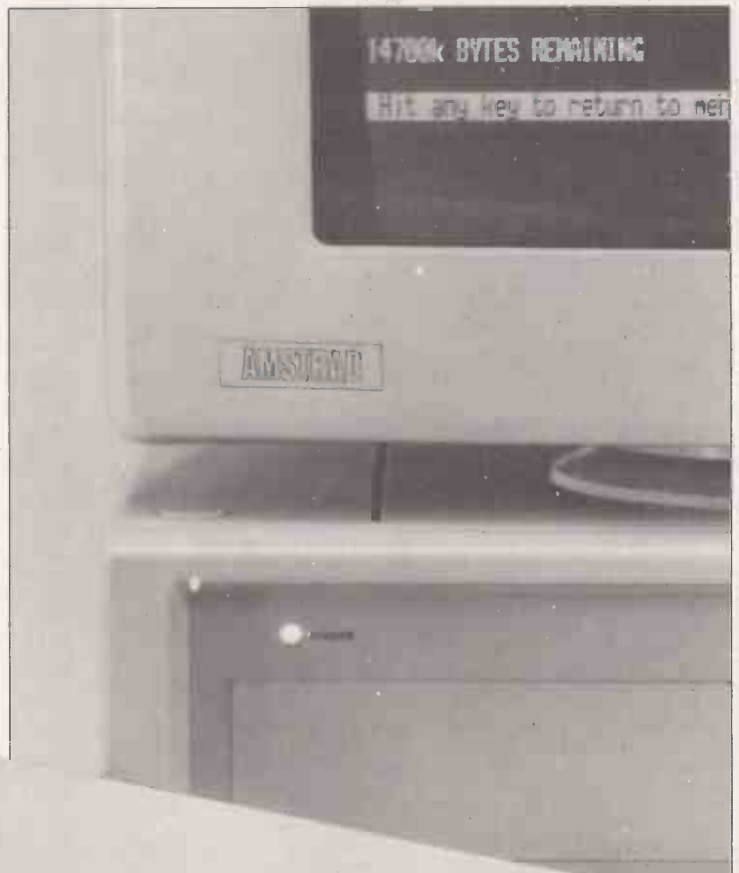

10 MBytes from £399
20 MBytes from £499

Cristie

15 years experience in manufacturing computer peripherals.

Cristie Electronics Limited, Bonds Mill, Bristol Road,
Stonehouse, Gloucestershire GL10 3RF
Telephone: (Sales line) 045382 – 8824; (Switchboard) 045382 – 3611
Telex: 43551 Cristy G; Fax: 045382 – 5768



COMMS LINK

BY JACK SCHOFIELD

TEXTLINE

REUTERS HAS RECENTLY ADDED THIS NEWS AND CURRENT AFFAIRS DATABASE TO ITS STABLE OF ON-LINE INFORMATION SERVICES.

Reuters, founded in 1851, is one of the most respected names in journalism, with over 1,000 journalists reporting the news as it happens from the world's faraway places. It has staff in 144 offices in 80 countries, and has recently had correspondents expelled from Cuba, Iran and Singapore.

What turned Reuters into a goldmine for the Fleet Street newspapers which held large blocks of shares was not, however, reporting. Reuters was a pioneer in the on-line information business. When the world's financial markets switched to on-line trading it was ideally placed to become a leading supplier to a cash-rich market where information is money.

Since 1982, the revenues of Reuters Holdings plc have grown from £180 million to £621 million. The latest annual report, published in April, shows that last year turnover grew by 43 percent and profits by 39 percent. About 83 percent of revenue now comes from outside the United Kingdom and Ireland.

In part, Reuters has grown by acquisitions; last year it spent £72.5 million buying up companies. In the U.S. it bought Instinet, which runs an automated trading network, as well as Network Utilities Inc. and Reveal Software Inc. In Canada it is buying I P Sharp, another international information provider, which also runs its own global packet-switched data network. In the U.K. it bought L H W Whyatt Brothers for £12 million and Finsbury Data Services for £10.8 million in cash and shares. This is rather a lot of money for a small database provider with only a couple of thousand users and annual sales of maybe £4 million. The prospect of offering information via Reuters' 100,000 or so existing terminals is clearly an attractive one.

Finsbury Data Services offers the Textline news and current affairs database. This is essentially menu driven, with copious prompts which make it relatively easy for newcomers to use; more experienced users can enter an S for short prompts. The first menu after signing on offers a choice of Textline, Newline, Dataline and Additional Services. Newline is simply a week's headlines, while Dataline carries company information. However, it is the Textline database that is the important service.

On Textline there are several options available to limit the area of the search. For example, you can choose from 10 geographical areas, such as U.S., Far East and India. You can also choose from 11

specialist areas from A to K, where A is Banking and Finance, H is Electronics and Computing, and K is Travel. In some of these specialised areas, Textline is very strong indeed. Finally there are eight codes for time periods ranging from the last month to the entire period since the start of the database.

Once your search is completed the system tells you how many hits you have for each element. You can then amend the search, or print out the headlines and texts as required, in either chronological or reverse order. The one other command you really need to know is the Backslash, which moves you back up the menu tree by one level. To log off you enter several Backslashes in sequence or type in

END

The major problem with Textline is that searching a largish section of the database is very, very slow. It flags you with the message "The database is still being searched" every 40 seconds or so while this is going on. I found that even in the middle of the night, when most financial traders are in bed, it could take two or three minutes for a search. This is in sharp contrast to my own standard database, World Reporter, where the

response is almost instant. At over £1 a minute this is one reason for choosing the latter system.

To get better results from Textline you need to delve slightly further and start using company mnemonics and codes. Company mnemonics are often obvious: IBS for Immediate Business Systems, for example. They are particularly useful when a company name is made up of the sort of words that might crop up in all sorts of odd articles. For example, searching for the code lmbank is a better bet than trying the full name, Image Bank.

Codes are also available for industries, topics, countries and regions, sources, and key words. For example, the code for air accidents is 433, while 1326 is mechanical power-transmission equipment, Maurts is Mauritius and Sht is the *Shetland Times*. If you happened to remember a report of a Mauritian plane crash in the *Shetland Times*, you could find it. You enter < and a number to tell the system what type of code you have used. For example, to see if the *Wall Street Journal* Computer Review had written about IBM you would enter

IBM<1+IACWST<5

You can enter ! to jump straight from the

SEARCHING ON TEXTLINE

1. Full Search Facility
2. Simplified Search Facility
3. Indexing Terms

Enter code number required (with 'S' suffix for short prompts): 1

FULL SEARCH FACILITY

Search terms up to a maximum of TWELVE may be selected from:

- * Company codes with optional 'X' suffix
- * Industry codes ('I' prefix) and Product codes ('PD' prefix)
- * Topic codes of 1,2, or 3 digits, with 'T' prefix
- * Country and Regional codes with optional 'Z' suffix
- * Source codes
- * Key words or phrases
- * Free text - single words or phrases
- * Personal names - Surname:Initial:Title eg. SMITH:A:SIR

Operating procedures

- * Search terms must be separated by either a plus sign (+) for 'AND', a comma (,) for 'OR', or a minus (-) for 'NOT'
- * For increased precision add chevrons and code numbers as follows:-
Company code: <1 Ind/Prod code: <2 Topic code: <3
Country code: <4 Source code: <5 Key word/phrase: <6
- * Single words may be truncated to stems of 4 chrs with an asterisk as a suffix
- * Brackets [] can form a compound search term within a total question

Enter requirements:-

:ibm+pc+april

Databases sourced from these areas and industries are available for searching:

General:	Updated to:	Updated to:
1. UK & W. Europe	12- 3-87	6. Central & S. America 5- 3-87
2. USA	23- 2-87	7. USSR & E. Europe 2- 2-87
3. Middle East	25- 2-87	8. Africa 24- 2-87
4. Far East	21- 2-87	9. Canada 4- 2-87
5. Australia & N.Z.	17- 2-87	10. India 23- 2-87

The start of a long-form search for April references to the IBM PC.

(continued on next page)

(continued from previous page)

database to the indexing system. The problem is, it takes time to look up all these codes, and the resulting search string quickly starts to look incomprehensible. The chances of error are large.

Another point is that most Textline entries are summaries, not full texts. Thus a longish article may be condensed in a dozen or two lines of reporting: "The Economist says that . . .", and so on. If you need fast information that is probably a benefit; if you are a journalist combing for detail it is not too useful. And note that not all stories are covered. The fact that there are some entries from, say, the *Guardian* does not mean more than a fraction of the *Guardian* has been abstracted.

A major advantage of abstracts is that Textline can thereby offer key stories from a vast number of sources without covering half the country in hard discs. In London it draws on over 250 publications; with specialised databases brought in from IAC and World Banking Abstracts the number goes well over 1,000; this compares with a few tens in many other on-line services.

Producing an accurate precis of an article is a highly skilled editorial job which takes time — rather more than loading up a few tapes which, with any luck, have been supplied by the original newspaper or magazine. As a result most of Textline's

information seems to run about three or four weeks after the original publication, and I found there was little point in searching only over the last month.

Again this meant that Textline was not very useful for me. I want to know what stories I missed in the last week, and anything over a month or two old is of little value. However, for someone doing background research the material is valuable; one of Textline's great advantages is that it goes back to 1980, which is a long time by U.K. database standards.

HIGH CHARGES

When it comes to charges, Textline also failed to woo me from World Reporter. I was given a free trial of the service so the log-off charging information consisted mostly of zeros, which made it hard to cost individual searches. However, the usage charge of £70 per hour is higher than World Reporter's, and Textline adds an extra 5p per headline and 10p per abstract accessed. Textline also charges £50 up front for manuals, though you get this back in reduced usage charges.

The menu system takes up more time than the simple Select/Get/Pick routine of World Reporter, its search strings are more complex and take longer to refine, and its searches are much slower. I would guess that Textline sessions are around twice as long and cost more than twice as much as World

Reporter sessions, though regular Textline users no doubt become skilled enough to even out the costs somewhat.

Textline's access provisions are also grossly inadequate. It offers only 300/300 baud direct dial-up and does not offer a club PSS account, which adds further to the cost. I used my personal PSS account which, of course, only works at my local Pad. With World Reporter I can call direct at 1,200 baud or get access via Telecom Gold from any PSS pad in the country using Gold's club PSS identity.

As you'll have gathered by now, I am not planning to add Textline to my list of regular databases. However, it clearly has merits as it is one of the most well used of its type in the U.K. Also, I have every confidence that it is going to get better in the future. Reuters does not seem to have made any impact on its recent acquisition so far, but it certainly has the energy, the will, the potential audience and the cash to turn Textline into a top-line product. While I'm not too impressed with it now, Textline offers a secure foundation for Reuters to build on.

Finsbury Data Services is at 68-74 Carter Lane, London EC4V 5EA. Telephone: 01-248 9828. Telex 892520. Direct dial to Textline: 01-248 5788 (300 baud). PSS NUA: A219200101. Parameters are seven-bit ASCII, 1 stop bit, no parity. 

ALL SYSTEMS GO BUT HOW FAST?

If you found a way to save hundreds of hours a year — would you use it?

Yes? Then **MicroCache's** speed enhancements are for you. **MicroCache** is three software packages in one. All three will, to quote a Shropshire dealer, make your system "go like a freshly whipped ferret". What's more, one of them is absolutely FREE with the other two!

DISK CACHE

Disk caching uses spare RAM to speed up disk accessing by up to 500 times. In normal use expect a two-to-ten fold overall speed improvement when reading from both floppy and hard disks. Most systems usually have plenty of unused RAM. or, add up to 4 Mb for even better performance.

SpeedWrite

New! Allows background writing to disk — dramatically improving performance still further.

Does reading or writing a 200 Kb disk file in under two seconds appeal? Order your MicroCache now!

PRINTER BUFFER

SpeedPrint operates like no ordinary printer buffer. It's up to five times faster...extracting data directly from your application program at up to 50,000 characters per second. Avoid the delays inherent in serial/parallel and built-in buffer interfaces. Ideal for both printers and plotters.

You keep full keyboard control of the printing process at all times. Buffer size? From 70 Kb to 4 Mb can be allocated or shared with the Cache.

SCREEN ACCELERATOR

Faster display updates. Faster cursor movement. Enhances sluggish screens. And it's FREE with **MicroCache**.

FREE!
DEMO DISK
IBM 5 1/4" Format
(Limited period only)
EXISTING USERS!
Contact us for your
Speedwrite upgrade.
(Only £45)

FEATURES

- ✓ FAST! ✓ Easy to use. ✓ Completely automatic.
- ✓ Compatible with your software. ✓ No changes to make to your system. ✓ Efficient use of all types of RAM. ✓ Makes RAM Disks obsolete. ✓ You don't rely on any special hardware. ✓ No circuit boards to fiddle with. ✓ All floppy and hard disks supported. ✓ Available for most micros. ✓ Cuts waiting time.



Microcosm Research Ltd
26 Danbury Street
London N1 8JU
Tel: 01-226 9092
Telex: 24263 TARDIS G

To: **Microcosm Research Ltd**, 26 Danbury St, London N1 8JU
 YES! Rush me a FREE **MicroCache** Demo Disk.
 YES! Rush me **MicroCache**. Despatch will be made within 2-5 days from receipt of order. I wish to pay £ by Cheque or Access Card 
 Full refund if not completely satisfied.
 Access Card Number: _____

Name: _____
 Company: _____
 Address: _____
 Tel No: _____

Disk Cache £89.00 SpeedPrint Buffer £95.00
 Cache + SpeedWrite £125.00
 Cache + SpeedWrite + SpeedPrint — ONLY £195.00
 SpeedWrite Upgrade £45.00
 Please add £3 p&p plus VAT at 15%
 Computer Type (PCDOS/MSDOS only)

COMPUMART

WATFORD (0923) 55633

IBM

	Mono	Colour
PC XT (SDD):(640k RAM 2 x 360k Disk)	£1100.00	£1290.00
PC XT (SFD):(640k RAM 360k + 20Mb Disk)	£1400.00	£1600.00
PC XT (286):(640k RAM 1.2Mb + 20Mb Disk)	£2000.00	£2200.00
PC ATX:(512k RAM 1.2Mb + 30Mb Disk)	£2975.00	£3170.00

All prices include Keyboard, Monitor & DOS

8087 Chip £195.00 80287 Chip £295.00 AT 360k Disk £145.00

TOSHIBA

Lap Top Computers

T1100:(256k RAM, 3 1/2" 720k Disk, 80C88 Co-pro, DOS 2.1)	£1122.00
T1100 Plus (640k RAM, 2x3 1/2" 720k Disks, DOS 3.2, and A/C Adapter-Charger & Carrying Case:	£1450.00
T3100:(640k RAM, 3 1/2" Disk + 10Mb H/Disk, 8MHz 80286 Co-pro, Clock Cal)	£2772.00

olivetti

Desktops

	Mono	Colour
M24:(640k RAM 360k + 20Mb Disk)	£1683.00	£1897.00
M24SP:(640k RAM 360k + 20Mb Disk)	£1826.00	£2040.00
M28:(512k RAM 1.2Mb + 20Mb Disk Bs. Con)	£2266.00	£2493.00
M28:(512k RAM 1.2Mb + 40Mb Disk Bs. Con)	£2730.00	£2958.00

All prices include Keyboard, Monitor & DOS

PRINTERS

Dot Matrix	Epson FX800:(240cps, 35cps NLQ, 80col)	£444.00
	Epson FX1000:(240cps, 35cps NLQ, 132col)	£453.00
	Epson LQ1000:(180cps, 60cps NLQ, 132col)	£681.00
	NEC P660:(180cps, 72cps NLQ, 80col)	£410.00
	NEC P760:(180cps, 72cps NLQ, 136col)	£490.00
	NEC P565XL:(264cps, 88cps LQ, 136col)	£885.00
Letter Quality	Toshiba P351	£856.00
	NEC SpInwriter 8850:(55cps)	£899.00
	IBM Quietwriter Model 1	£858.00
	IBM Quietwriter Model 2	£1075.00
	HP Laserjet (8ppm)	£1496.00
Plotters	HP Laserjet Plus (8ppm + graphics)	£2200.00
	HP 7440A:(A4) £776.00 HP 7475A:(A3) £1366.00	All prices include cable

SPECIAL OFFERS

Taxan mono monitor 12"	£135.00	Paradise AutoSwitch EGA	£279.00	AST Rampage 512k for AT	£428.00
Princeton mono monitor 12"	£161.00	Hercules Mono Plus graphic card	£199.00	QUAD EGA (short)	£229.00
Princeton colour monitor 12"	£352.00	Mountain Hardcard 20Mb	£620.00	DC 600A Tape	£26.00
Princeton EGA monitor 12"	£395.00	AST SixPac 384k	£418.00	DC 1000A Tape	£14.00

Please ring for an immediate response and the latest prices

Prices exclude VAT & Delivery ALL MAJOR CREDIT CARDS ACCEPTED All prices are subject to C.W.O.

COMPAQ

Portables

Portable I:(256k RAM 2 x 360k Disks)	£1397.00
Portable I Plus:(360k Disk + 10Mb H/Disk)	£1817.00
Portable II Model 2:(256k RAM 2 x 360k Disk)	£1680.00
Portable II Model 4:(640k RAM 360k Disk + 20Mb H/Disk)	£2275.00
Portable 286 Model 3:(640k RAM 1.2Mb + 20Mb H/Disk + 10Mb Tape)	£3147.00

All prices include DOS

Deskpros

Deskpro Model 2:(256k RAM 2 x 360k Disks)	£1307.00
Deskpro Model 3:(640k RAM 360k + 20Mb Disk)	£1797.00

New 12MHz MODELS 50% FASTER

Deskpro 286 20:(640k RAM 1.2Mb + 20Mb Disk)	£2367.00
Deskpro 286 40:(640k RAM 1.2Mb + 40Mb Disk)	£2718.00
Deskpro 286 70T:(640k RAM 1.2Mb + 70Mb Disk + 40Mb Tape Backup)	£4245.00
Deskpro 386 40:(1Mb RAM 1.2Mb + 40Mb Disk)	£4706.00
Deskpro 386 70:(1MB RAM 1.2Mb + 70Mb Disk + 40Mb Tape Backup)	£5186.00

All prices include Keyboard, Dual-Mode Monitor & DOS

COMPAQ PORTABLE III

640k, 286 Processor, 1.2Mb Floppy, 20Mb H/Disk:	£2914.00
640k, 286 Processor, 1.2Mb Floppy, 40Mb H/Disk:	£3234.00

All prices include DOS

SOFTWARE

Multimate Advantage	£346.00	Dbase III Plus	£399.00
Wordstar Professional	£290.00	Smart	£486.00
Displaywrite III	£322.00	Symphony	£355.00
Lotus 1-2-3	£247.00	Paradox	£430.00
SuperCalc IV	£230.00	Microsoft Mouse	£140.00

Other Printers, Multifunction Cards & Software available.

EX-RENTAL EQUIPMENT

Please telephone Steven on (0923) 53933 ext 2550 for information and prices on current stock.

COMPATIBLE INCOMPARABLE

The Amstrad DMP 3000 Ten inch carriage.

Draft quality speed of 105
characters per second.
Near letter quality (NLQ) speed
of 26 characters per second.
Compatible with IBM and Epson.
Easy front loading of paper.
Friction or Tractor feed.
All for the remarkably
low price of

£169
PLUS VAT



E PRINTERS. BLE PRICES.

The Amstrad DMP 4000
Fifteen inch carriage.

Draft quality speed of 200 characters per second. Near letter quality (NLQ) speed of 50 characters per second. Compatible with IBM and Epson. Friction or Tractor feed. All for the remarkably low price of

£349
PLUS VAT

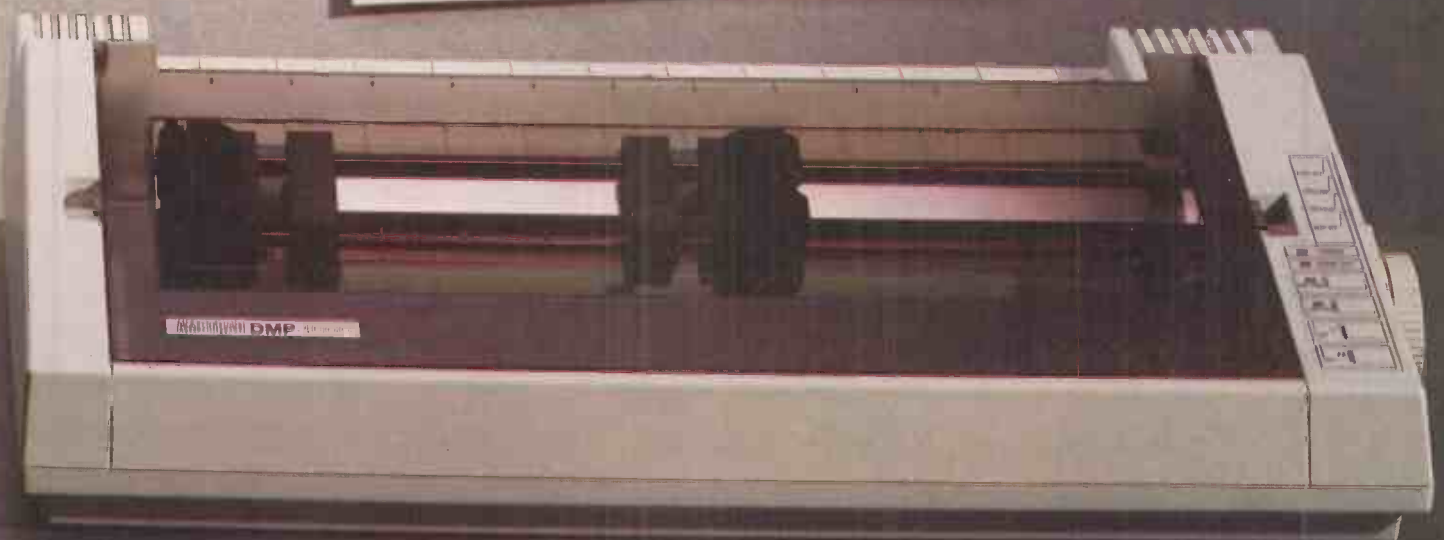

Please send me further information on the DMP 3000 and DMP 4000

Name

Company Telephone

Address

AMSTRAD PRINTERS

Amstrad plc., PO Box 462, Brentwood, Essex CM14 4EF. Telephone: (0277) 262326.



PC1512 from £449 inc. Free 640K Upgrade



Authorised Dealer from £499

Tandon PCX & PCA SUPPLIED WITH 12 MONTHS FREE ON-SITE MAINTENANCE

BASIC AUTOCAD SYSTEM

Opus System 4 (20MB, IBM RAM) 720 x 348 resolution mono parallel serial ports. Basic Autocad. Summouse, Hitachi A3 plotter

£1799

ADVANCED AUTOCAD SYSTEM

PCA20 (20MB, 1MB RAM) 720 x 348 resolution on 14" screen 1 parallel & 2 serial ports Autocad plus ADE 2 & 3. Cherry A3 digitiser Roland DPX2000 A2 plotter and stand

£6599

We can tailor Autocad systems to your requirements due to our extremely wide range of support peripherals (see below) Installation and training — independent consultancy service available. Please call for details.

VIKING ULTRA HIGH REVOLUTION 19" DISPLAY — Ideal for Desk Top Publishing & CAD. Please call.

ALLOY MULTI-USER Turn your XT/AT into a Novell compatible multi-user system from **£1199 per station**

£559

ATARI 1040 ST (while stocks last)

HARD DISK & MEMORY UPGRADES

IBM & Compatibles 20MB.....	£359
IBM & Compatibles 30MB Hardcard.....	£379
Sanyo Memory upgrade to 256K + RAM disk + 25% extra disk capacity.....	£65
Amstrad PC 1512 upgrade to 640K.....	£29

APRICOT ADDS ONS

512K Memory Board.....	£115
20MB Hard Disk Upgrade.....	£695
Hi-Res Monitor for Portable.....	£109

PRINTER PROMOTIONS

Panasonic 1081.....	£169
MP 165.....	£189
Star NL 10.....	£215
Epson FX800/1000.....	£319/£399
M. Tally MT85/86.....	£299/£399
EPSON EX800/1000.....	£399/£539
NEC P6/P7.....	£409/£499
Epson LQ800/1000.....	£459/£619
Juki 6100.....	£259
Quendata 1120.....	£169

SHEETFEEDERS Please Call

ACOUSTIC HOODS Please Call

PRINTER BUFFERS

Serial/parallel in/out 8K-2MB from.....	£79
---	-----

*New * All Purpose X-buffer — Please Call

FANFOLD PAPER All sizes available

11" x 9 1/2" 60gm.....	£9.75 (2000 sheets)
12" x 9 1/2" 60gm.....	£3.99 (2000 sheets)
A4 Clean Edge—70gm.....	£15.95 (2000 sheets)*
Edge — 85gm.....	£9.30 (1000 sheets)
11" x 14 1/2" 60gm.....	£13.50 (2000 sheets)*

Delivery £2.65 (fixed) — £1 per box
Extra £1 per order for items marked *

LABELS 70mm x 36mm..... £2.95 1000

89mm x 36mm.....from £3.25 1000
Please call for other sizes.

RIBBONS for all printers eg

EPSON FX, MX, RX 80/100.....	£2.49/£3.75
EPSON LX 80.....	£2.95
JUKI 6100 single strike.....	£1.15

SHINGWA/M TALLY MT80.....	£3.79
KAGA/CANON.....	£3.99
QUME MS4.....	£2.65
APPLE IMAGEWRITER.....	£3.35

PRINTWHEELS from..... £3.75

Delivery 95p Quantity ribbons/printwheels

SOFTWARE SPECIALS

Ventura DTP.....	£695
Supercalc 4 Lotus Eater.....	£195
VP Planner Lotus Clone.....	£85
VP Info.....	£65
Perfect Writer 2.....	£99
Wordstar 3.0 (IBM).....	£349
Wordstar 2000.....	£225
Word Perfect.....	£265
Turbo Pascal (8087 + BCD).....	£55
Turbo Reflex.....	£69
CADpower.....	£259
Turbocad.....	£299
CADD inc. mouse.....	£169
Autosketch.....	£79
Ability-Integrated Package.....	£79
Moneypower.....	£79
Sage Financial Controller.....	£249

PLOTTERS — DIGITISERS etc.

Hitachi 672 A3.....	£449
Roland 880A A3.....	*£679
Roland 885 A3 SPECIAL OFFER.....	£929
Houston DMP42 A1.....	£3099
Roland DPX2000 A2.....	**£2495
Graphtec GP9001 A0.....	£6,195
Summasketch 12" x 12" digitiser.....	£395
Cherry A3 digitiser.....	£495
Logimouse with IBM support software.....	£85
Summouse with GEM + Write & Paint (IBM).....	£179

*Inc FREE 11k buffer **inc stand

DISKS — POST FREE Packed in tens No quibble guarantee

Prices for ONE box. 10% EXTRA DISCOUNT for each extra box.

	DYSAN	SONY	PISION
5 1/4"			
SSDD	£13.40	£11.90	£8.90
DSDD	£16.90*	£14.90	£10.90
DSQD	£23.90	£17.90	£13.90
HD 1.6MB	£29.90	£27.90	—

***DYSAN DSDD — 1 EXTRA DISK PLUS LIBRARY CASE**

SONY 3.5" SS£16.90 DS£23.90

AMSOFT 3" £28.90

LOCKABLE 40 3 1/2 DISKS.....£7.95

DISKS BOXES 70 5 1/4 DISKS.....£9.95

Official Government/Educations Authority orders welcomed.

Please add 15% VAT to all prices (inc. carriage) Limited space precludes listing of our full range of products. Please telephone if you do not see the item you require.



BY MIKE LEWIS

WHERE TO DRAW THE LINE

GRAPHICS PROGRAMMING EMPLOYS SPECIALISED TECHNIQUES THAT, ONCE MASTERED, CAN GENERATE SOME ATTRACTIVE EFFECTS.

Computer graphics is one of the more fascinating branches of programming. It is also, arguably, the most underestimated. We are becoming so used to throwing pie charts and histograms at our screens that we often take for granted the complex programming that lies behind them. So it is worth taking a closer look at some of the fundamental algorithms that make computer graphics work.

Take the humble task of drawing a straight line, for example. This might sound simple enough and given suitable hardware it is a straightforward job to plot a horizontal or vertical line. But producing diagonals is another matter. In fact, writing a general-purpose line-drawing routine is a lot harder than it sounds.

One possibility might be to use the standard formula

$$y = mx + c$$

where y and x are the vertical and horizontal co-ordinates of any point on the line, and m and c are constants. For any pair of end-points, (x_1, y_1) and (x_2, y_2) , you can calculate m and c . Then for a selection of values of x between x_1 and x_2 you can determine the corresponding values of y . They would then give the co-ordinates of the points forming the line.

Although this technique will work, it is not the most popular way of drawing lines. The reason is that it involves multiplication, and on modern computers multiplication is relatively slow. In the 1960s, when graphics algorithms were first developed, it was to be avoided at all costs.

The classic straight-line algorithm dates back to 1961. It was invented by Jack Bresenham, an engineer with IBM, who had to

write a program to drive an incremental plotter from a 1401 computer. He came up with a method of drawing lines that was so simple that it has never been bettered. It was a method that involved addition, subtraction and sign testing only — no multiplication. It can still be found deep down in the most sophisticated of modern graphics applications.

You can see how Bresenham's algorithm works by studying the first subroutine in listing 1. The routine connects any point (a, b) with the point $(0, 0)$. A more general version would connect an arbitrary pair of points, (x_1, y_1) and (x_2, y_2) , but it is an easy matter to adjust the co-ordinates to achieve this.

What the listing does not show is how actually to plot the points that form the line. I have cheated slightly by using Basic's PSET command. In practice this would be meaningless, as Basic has its own built-in line-drawing command, but it will serve to illustrate the technique.

There is, of course, no general instruction for plotting a single point. It all depends on the hardware and the language being used. It might involve firing a hammer in a matrix printer, lowering the pen on a plotter or lighting up a dot on a video display. Whatever the hardware, you have to get this right because drawing dots is at the heart of every graphics program.

Once the line-drawing routine is in place you can use it to build more complicated shapes like rectangles, triangles and other polygons. You can even use it to draw a circle. Obviously, a true curve cannot be made out of straight lines, but the resolution of the human eye is low enough to make a sequence of very short lines look like a

curve. So an approximate circle can be created by drawing an equilateral polygon with a large number of short sides.

With a raster device like a video screen this idea can be taken a stage further. You can make a circle out of a polygon whose sides are all just one dot — or pixel — wide. If the circle has a radius r you need to plot $2\pi r$ pixels. And if the centre of the circle is at $(0, 0)$, each of the pixels is at the point

$$(r \cos(\theta), r \sin(\theta))$$

where θ is the angle in radians that a line from the centre to the point makes with the positive x -axis.

Drawing a circle thus resolves itself to plotting a series of points for values of θ between 0 and 2π . The second subroutine in listing 1 shows how this is done. Here the routine is made slightly more general by allowing the centre of the circle to be at an arbitrary point (X_c, Y_c) . There is no way of avoiding multiplication in this routine.

People who draw circles on a computer screen are often surprised to see the finished product looking more like an ellipse. The reason is simple: pixels are not necessarily square. On the screen of an IBM PC, for example, they are usually higher than they are wide, so circles tend to look as if they have been squashed at the sides.

Writers of graphics software go to great lengths to overcome this discrepancy, the size of which is indicated by a measure known as the aspect ratio. This is no easy task because there is no way for a program to find out the aspect ratio of the hardware on which it is currently running. Usually this information has to be hard coded into the program.

If you do know the aspect ratio for your

LISTING 1. LINE DRAWING ROUTINES

```
1000 'Bresenham's algorithm: a line-drawing
      routine, using addition, subtraction
      and sign-testing only. Draws a line
      from (0,0) to (a,b), for a>=b>=0
1010 'Assumes the presence of a hardware-
      dependent subroutine (at line 2000)
      for plotting a single point at (X,Y)
1020 X=0: Y=0: DX=A: DY=B: D=DY+DY-DX:
      INC1=DY+DY: INC2=(DY-DX)+(DY-DX)
1030 WHILE X-DX<=0:
      GOSUB 2000 'Plot a point at (X,Y)
1040 IF D<0 THEN
      D=D+INC1
      ELSE
      D=D+INC2: Y=Y+1
1050 X=X+1
1060 WEND

1070 RETURN
1500 'Routine for drawing a circle, with
      centre (XC, YC) and radius R
1510 PI=3.1416: INC=1/R: N=2*PI
      'Pi, increment, and max. value of theta
1520 FOR THETA=0 TO N STEP INC:
      X=R*COS(THETA)+XC: Y=R*SIN(THETA)+YC:
      GOSUB 2000:
      NEXT THETA 'Plot each point in turn
1530 RETURN
2000 'Routine for plotting a single point
      at (X,Y). This for illustration only;
      substitute something applicable to
      the target hardware
2010 'MAXY is the width of the screen
2020 PSET(X,MAXY-Y)
2030 RETURN
```

(continued on next page)



(continued from previous page)

particular screen you can draw a better circle by setting out to draw an ellipse. The longer axis could then be in the direction of the shorter pixel width, thus compensating for the distortion. Plotting an ellipse is very similar to plotting a circle, except that each pixel is at the point

$$(a \cos(\theta), b \sin(\theta))$$

where a and b are the major and minor axes. A circle is clearly a special case of an ellipse, in which a is equal to b.

If you want to amuse yourself with these algorithms, you can create some eye-catching graphics with fairly simple combinations of lines and curves. For example, try plotting a circle with a radius of 100 and about 100 points on the circumference. Then draw a straight line connecting every point with every other point. The best approach is to calculate the co-ordinates of the 100 points once only and hold them in an array.

A more difficult technique of computer graphics is space-filling, otherwise known as the paint-pot problem. The idea is that you move the imaginary paint to a point on the display, pour it out of its container and watch it fill the area which is bounded by a continuous line around the pot. If there is a gap in the line, the paint flows through it, filling a larger area.

This operation is very hard to program efficiently. Whatever technique you use it

LISTING 2. SPACE FILLER

```

procedure paint(x,y:integer);
  {fills an irregular shaped area; assumes
  the existence of procedure plot(x,y), to
  draw a single point, and of function
  isplotted(x,y), which returns true if the
  point is already drawn, or if it is at
  boundary of the display}

begin
  if not isplotted(x,y) then begin
    plot(x,y);
    paint(x+1,y);
    paint(x-1,y);
    paint(x,y+1);
    paint(x,y-1);
  end;
end;

```

requires lots of memory, lots of time, or both. If the shape to be filled is a polygon with vertices at known co-ordinates, then it is not so bad. At worst, the problem could be resolved to drawing a series of straight lines within the boundary of the shape.

More typically, the program is required to fill an arbitrary, irregular space whose boundary line is not known in advance. The normal way to do this is to use a recursive subroutine that fills a much smaller space. This smaller space consists of the current point and its four neighbours — that is, the points immediately above, below, to the left and to the right of the current point.

Before plotting these points, the recursive routine checks to see if the current point is already plotted. If so, it exits. This means either that it has come to a boundary, or that the local area has already been filled. When the highest-level routine in the recursion stack is exited, the shape has been completely filled.

Listing 2 shows this routine. Because Basic does not support recursion I have written it in Pascal. Do not be deceived by its simplicity. Recursion demands a heavy overhead of time and space. Although only a few lines long, the routine takes quite a while to run and uses a good deal of memory. 

STACKING FRAMES

Overcrowded computer room?
- Reclaim valuable floor space
with a purpose built stacking
frame.

* Designs available for the most popular controllers.

IBM 3174 local and remote
IBM 3274 local and remote
Memorex local and remote
Harris Systems

* Cable management

* Cable protection end panels

* Colour: IBM beige

From
£159.00

Price excludes VAT and delivery.
Official purchase orders welcome.

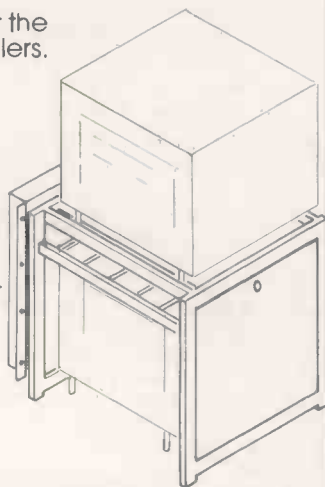

MDS

MDS Industries (UK) Limited
Factory 1 Ebbens Road
Hemel Hempstead Herts HP3 9QS
Tel: (0442) 217875

IEEE488

TECHNOLOGY THAT HITS THE MARK

- Interface system for IBM-PC/XT/AT/IC and all compatible equipment
- Interface system for PHILIPS PC :YES
- HP control commands (ENTER, CLEAR... etc.) implemented
- SRQ interrupt software implemented
- DMA and INTERRUPT activated by simple commands
- 64 kByte memory management for processing large volumes of data
- Integrated control interpreter, HELP screen and HELP functions in decoded text
- Support for BASIC, BASIC (compiled), (TURBO-)PASCAL, MODULA 2, FORTRAN, C and ASSEMBLER
- Software and manual available in English, French and German



DEALERS WANTED!

INES GmbH, Neuenhöfer Allee 45,
5000 Köln 41, West-Germany
PHONE: -49 221 438659
TELEX: -2627 17 221 4237 gizkln
TELETEX: -2627 221 4237 gizkln
TELEFAX: -49 221 4972078

NEW

The Ultimate Storage Medium...



...Fuji's NEW 3.5" High Density Floppy Disk.



FUJI FILM

I & I
Imaging Information

To meet your demands for a 3.5" Floppy Disk that gives: High Density, High Resolution and High Reliability at Low Cost, Fuji have developed a brand new 3.5" Double Sided MF2HD Floppy Disk with ideas above its station!

With 2.0 MB of storage — the equivalent of 630 A4 pages — you will find it well able to cope with even the largest tasks.

And you will find it more reliable because of Fuji's exclusive DAT coating and DRR binder system. DAT stands for 'Dual and Accurate Thin Film Coating' which gives extraordinarily high coercivity of the super-fine Beridox magnetic particles.

DRR on the other hand (as if you hadn't guessed!) stands for Fuji's 'Durable, Runnable and Reliable' binder system which gives the new disk that extra high durability to withstand 20 million read/write operations.

As if DAT and DRR weren't difficult enough to comprehend — but 20 million passes per track! Whatever will Fuji think of next? Don't worry, there are many more exciting developments to come.

And don't forget Fuji offers a full range of Floppy Disks in the following formats: — 8", 5.25" and 3.5" diskettes.

For full details of Fuji's range of professional Floppy Disk products please contact:

FUJI PHOTO FILM (UK) LTD
Floppy Disk Division
125 Finchley Road, London NW3 6JH
Telephone: 01-586 5900

ADVANCED
DESIGN

WHAT'S SO
SPECIAL
ABOUT THE
WORLD'S MOST
ADVANCED
DESK-TOP
COMPUTER?

£2,999

X E N : H I G H P E R F O R M A N

IBM, Microsoft, Xenix, MUMPS, BOS, PICK, Concurrent DOS, Lotus 1-2-3 and Intel are all registered trade marks of their respective operating companies.

Introducing the remarkable new Apricot XEN-i 386. Quite simply, it is the most advanced desk top computer in the world.

As Which PC so aptly puts it, . . . "specifications which knock the socks off" . . .

Here's why: it will run any of your existing software ten times faster than an IBM PC.

At this kind of speed, even the latest crop of 286 machines cannot come close. Especially with the forthcoming 386

O/S 2 operating system which will enable sixteen different applications to run concurrently.

And the unique skills of Apricot have further enhanced the already staggering performance of the Intel 32-bit processor.

At a glance, the specifications alone can be seen to be rather special.

4 MIPS processor-speed; up to 25 Ms hard-disk access time (with a choice of 30 or 45 Mbyte storage); up to 16 Mbyte RAM; full IBM compatibility; and powerful multi-tasking software.

In addition, it gives the choice of either 5¼" standard floppies, or the new 3½" high-capacity drives.

So any current compatible software can be used to the full. But far faster than ever before.

And it will work together with all existing 'IBM-standard' monitors, cards and peripherals.

More importantly, it opens the door to the dazzling performance that the next generation of 386-based software will bring.

However, this XEN-i is also special in other ways.

Because XEN is unique in being the world's only computer system that can

be upgraded to the level of the most powerful.

It can become the heart of a major network or multi-user installation: running MS-DOS, Xenix, Concurrent DOS, BOS, PICK, or MUMPS. (As well as working with other computer systems and databases across any distance.)

Or turn it into the most sophisticated world-standard Desk Top Publishing system ever available.

Even the simple addition of the 387 co-processor will add yet another mind-boggling dimension to its processing power.

However, what is most special of all is the price.

By comparison, IBM will happily charge you over 50% more for their smallest 386 computer.

In fact you still pay 35% more for their equivalent 286-based PC.!

And in both cases, that is without all the on-board programs that Apricot take the trouble to include.

Such as the powerful Word-Processing with Graphics. Or the Lotus 1-2-3 compatible spreadsheet, VP Planner. As well as all the current MS Win-

dows software, giving you a calculator, clock, card-index, and personal diary.

To quote a recent independent review, the new XEN-i 386 is ". . . one of the most impressive and innovative PC offerings to appear from the UK for some years . . ."

It's available to you now from £2999.*

From over 250 specialist centres around the UK. Just call Freefone Apricot for more details.

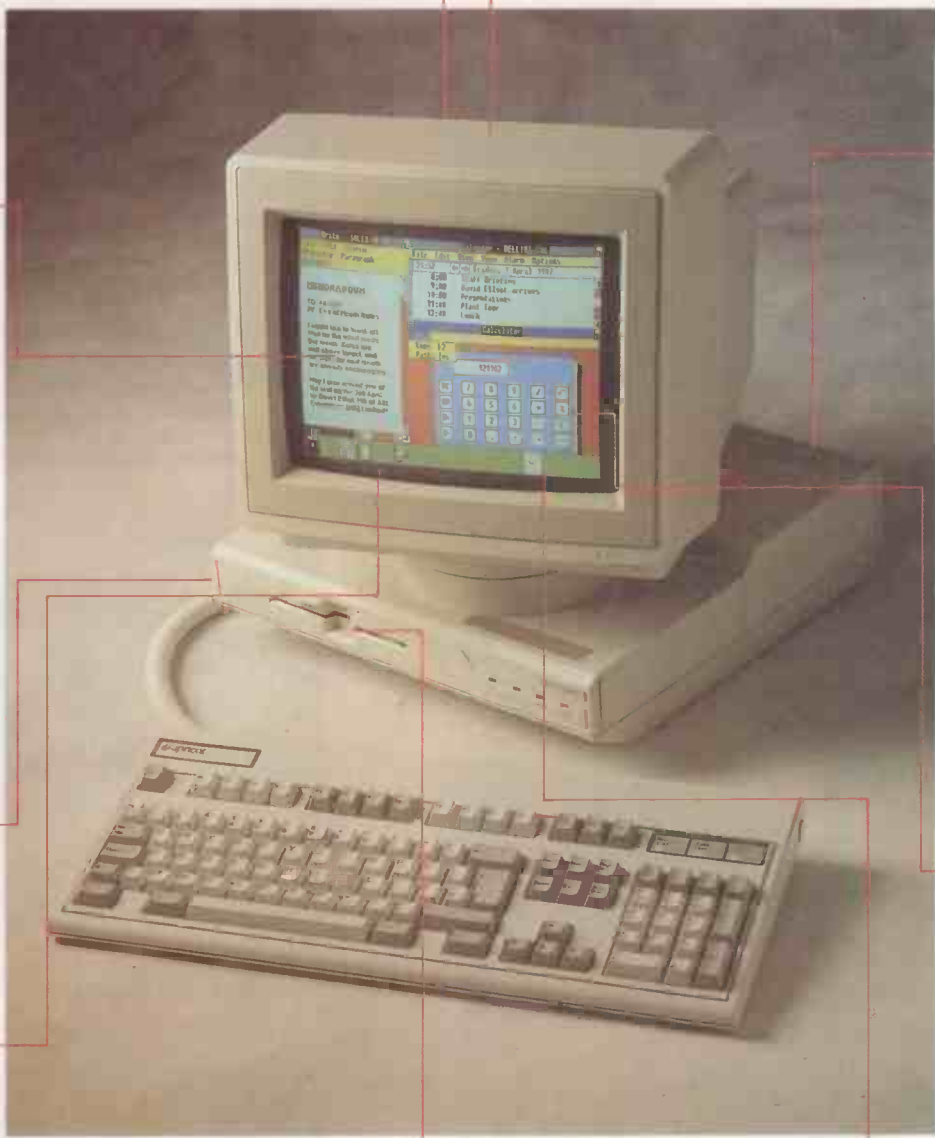

*Excludes monitor, adaptor card, and VAT. System illustrated is the XEN-i386/45 with High Resolution colour monitor.

E C O M P U T I N G S Y S T E M S

Apricot Computers plc, Apricot House, 111, Hagley Road, Edgbaston, Birmingham B16 8LB.

Taxmen, bank managers and accountants are easy to defeat.

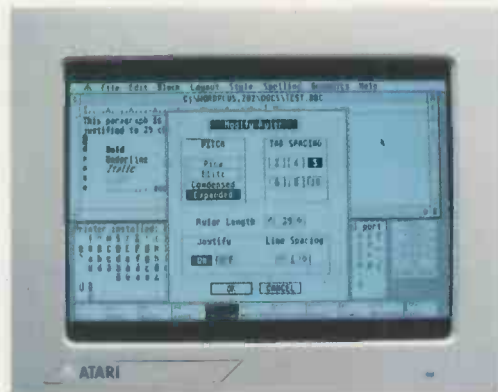

1st Word Plus – G.S.T. Professional word processor featuring U.K. spellings and integration of graphics including 1st Mail for full control of form letters etc.



Superbase Personal – Precision Software. All the features of GEM combined with full relational database power. Easy to set up, flexible, plus unique picture index facility.



Fleet Street Publisher – Mirrosoft. The complete desk-top publishing package. Gives you page make-up combining text and graphics for sophisticated, professional looking documents.



VIP GEM – Silica Distribution. VIP Professional is an integrated spreadsheet, database, and graphics package. GEM environment plus Lotus 1-2-3 compatibility.



Neochrome – Atari. A powerful, sophisticated painting program for unsurpassed graphics. Work boldly on full screen canvas or in minute detail using Neochrome's magnifier.



Fastcom – Atari. A professional communications software package giving access to most major databases worldwide. (Integrated ASCII/Viewdata package).

These other fiends may be a bit trickier.



Gauntlet – U.S. Gold. Enter a world of monsters, mazes, mystery and combat in the ultimate role-playing fantasy game.



Tai-Pan – Ocean. Voyage to 19th Century Hong Kong for action and excitement with pirates, smuggling and mutiny.



Metrocross – U.S. Gold! It takes lightning reflexes to get past the potholes, obstacles and forbidden zones to reach the other side. And that's just the beginning!



Arkenoid – Imagine! The latest smash-hit coin-op game! Are your reactions quick enough to handle 33 different play screens?

Mixing business with pleasure is no problem with an Atari 520 ST. Not when you've got over 1,000 software titles to choose from.

You'll find all the latest games and a huge range of business titles from the top business software houses. And the range is growing all the time.

You won't be short of power, either. The Atari 520 ST is twice as powerful as most business micros.

So you'll be able to create spectacular colour graphics. Even animate them to make your own films. If you're musically minded, you can compose and play a full symphony.

Or, for those who'd rather write programs than music, the 520 ST supports over thirty programming languages.

In fact, whatever you're looking for in a computer, you'll find it in the Atari 520 ST.



ATARI 520 ST
WORKS HARD · PLAYS HARD

*Screenshots are from the original Arcade game.

→ circle 104 on enquiry card ←



• C H I P - C H A T •

BY RAY COLES

MEMORY MOVES ON

ALREADY 4MBIT RAM CHIPS ARE BECOMING AVAILABLE IN MARKETABLE QUANTITIES, AND 16MBIT DEVICES MAY NOT BE FAR BEHIND.

At the International Solid State Circuits Conference (ISSCC) held in New York in February, the Japanese corporation Nippon Telegraph and Telephone (NTT) announced the development of a 16Mbit dynamic RAM using a 0.7 micron CMOS process. ISSCC delegates are difficult to impress: they turn up expecting to be faced with amazing revelations, staggering breakthroughs and mind-boggling bit capacities. But even the toughest of them recognised that the NTT device stole the show.

The chip has been developed by the Electrical Communication Laboratories of NTT. It is basically a research establishment, not a production house, and there are no immediate plans to turn the design into a marketable product. The NTT team was effectively engaged in a feasibility study to evaluate the techniques, technologies and problems involved in producing such dense devices. Yet the obvious success of their venture demonstrates that 16Mbit chips may not be so far away as was previously thought.

Using electron-beam lithography, which is not a high-volume production technique, NTT engineers were able to lay down about 40,000,000 different components on a CMOS chip measuring just 8.9mm. by 16.6mm. The state-of-the-art 0.7 micron process produces transistors and capacitors which are so small that the electrical stress imposed by standard 5V supplies is too high, and a 3.3V source has to be used instead.

The chip is organised as 2Mword by eight bits and has a very respectable 80ns. access time, despite the provision of an on-chip error-checking and correction (ECC) facility. The ECC circuitry is necessary for providing tolerance to both hard errors due to faulty bit cells and to soft errors. The latter may be caused by alpha particles arising from cosmic radiation or by the decay of radio-isotopes found in minute quantities in semiconductor packaging materials.

The NTT team is particularly pleased with the success of its novel ECC scheme. It only increases the chip area by about 15 percent. Also, the checking and correction it performs are done in parallel with read operations, and this reduces the access-time penalty to less than 5ns. Both these characteristics are considerable improvements on previous schemes.

There are several other innovations in the design of the NTT chip, and it has no doubt provided an excellent test vehicle for future Japanese production designs. It must also have removed any lingering doubts anyone

outside Japan may have been harbouring about the Japanese ability to innovate for themselves.

Interesting though the NTT chip is, the most important news to come out of ISSCC for memory-chip users concerns the imminent arrival of the 4Mbit DRAM as a commodity part. As readers of this column will know, the 1Mbit DRAM has itself only recently become available. Most machines, even many new ones, still employ the 256Kbit chips which are now being considered to be mature — and that means cheap.

At ISSCC, Mitsubishi Electric Corporation of Japan and IBM both presented papers on practical 4Mbit devices which will probably be in high-volume production before long. The Mitsubishi device has been designed with a particular emphasis on compatibility with the previous 1Mbit generation, allowing it to be fitted to existing board designs and thus to quadruple memory capacity. This approach is popular with equipment manufacturers and is likely to persuade both them and their customers to switch to 4Mbit devices at premium prices much earlier than if new board designs were required. The Mitsubishi design will fit into the same package commonly used for 1Mbit chips, and this has been achieved by reducing chip dimensions to a minimum, using 0.8 micron design rules.

Using low-power CMOS technology, the Mitsubishi device keeps power consumption down to 300mW and offers a 90ns. access time. The smallness of the charge which can be stored on conventional bit-cell capacitors when they are restricted to the tiny dimensions necessary on a 4Mbit chip makes them particularly susceptible to soft errors. Mitsubishi has therefore developed a folded bit-line adaptive sidewall isolated capacitor (Fasic) cell design to give a capacitance measuring a respectable 0.05pF.

The Mitsubishi 4Mbit design has a counterpart from IBM which is also fabricated in CMOS, though it is somewhat faster at 65ns. They are essentially different to the NTT 16Mbit monster in that they are both potential production parts that require little more than a corporate decision to be made for them to be manufactured in volume.

If the ISSCC evidence seems inconclusive, news from the European team made up of Siemens in Germany and Philips in Holland must surely clinch it. They are already producing samples of a 4Mbit device, so the 4Mbit DRAM must be just around the corner.

A range of new parts is available now for new designs. The 1Mbit generation is here with a vengeance, and Mitsubishi alone is producing 45 different varieties of 1Mbit DRAM. All are available in high volume and are finding sockets in systems using the latest 32-bit microprocessors, like the Motorola 68020 and the Intel 80386, which can really make good use of huge memory arrays.

High-resolution raster-graphics display terminals and engineering work stations also have big appetites for DRAMs in their screen-refresh memories. In this area new 256Kbit DRAM chips are the hot news. Memory manufacturers are catering for the video-graphics market by incorporating new formats and extra circuitry on to their 256K DRAM parts to make the design job much easier for the system manufacturers. The new 256K DRAM parts are called video RAMs, and they provide dual-port access for screen refresh and the system bus.

Typical of these new devices is the NEC uPD-41264, a 256K DRAM organised as 64K by four via the system port to drive the video display. The system bus sees the uPD-41264 as a standard RAM array while video data to refresh the screen can be read out asynchronously from the serial port in a way that is transparent to the processor.

The provision of a high-speed 256- by four-bit shift register on-chip allows the systems to use 95 percent of the RAM port bandwidth, while pixel data is shifted out of the register at dot-clock rates of up to 20MHz. The system is denied read or write access to the chip only while the shift register is being parallel loaded from the RAM array. Using conventional 256K DRAMs the system can gain access for only about 30 percent of the time — during video flyback — since the single RAM port has to be used for the readout of pixel data during the line-scan period.

An important additional benefit in high-resolution systems is that the fast shift register decouples the memory array from the high-speed dot clock. Ordinary but relatively slow memory technology can then be used instead of the premium-priced high-speed selections which might otherwise be required.

Because of its unusual architecture and its $\times 4$ format, the video RAM needs a 24-pin package. No doubt video RAM devices using 1Mbit technology will become available before long to provide the next step in the accelerating spiral of higher resolution at lower cost. 

To help you defeat
the taxman

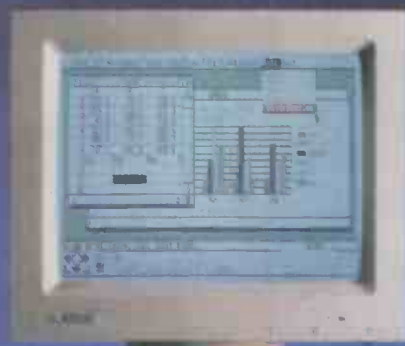

and destroy the
aliens,

we've massacred
the price.

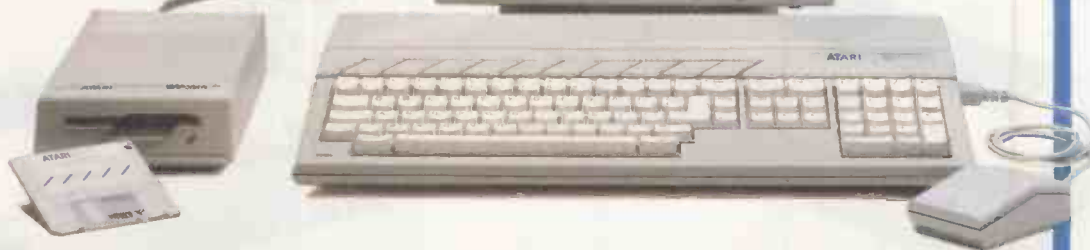

For a limited period, the Atari 520 STM is even more of a knockout than usual.

We're offering it for just £449.95 (inc. VAT) complete with SF354 disk drive, SM125 mono monitor,* a mouse worth £24.95 and 1st Word, worth £49.95.

So as well as saving you from the enemy, the 520 STM will also save you £184. You'd better hurry though, because it won't be long before our stocks are wiped out.

ATARI 520 STM
WORKS HARD · PLAYS HARD



* Offer includes mono monitor. The 520STM plugs into a standard colour TV.

→ circle 105 on enquiry card ←

Dynasty.

The Qume family of letter-quality printers is now into everybody's business.

As a world leader in letter quality printers for all business computer systems, Qume has been building up its name for over a decade. For combined qualities of simplicity, value for money, compatibility and stamina its supremacy is incontestable. And now more than ever it is also Qume for choice. The family representatives here span the whole spectrum of applications.

Laser TEN PLUS. Qume waited until they were perfectly ready before introducing a second generation laser, thus ensuring it would be a whole lot easier to install and operate. And be easily compatible, too. Laser TEN PLUS produces 10 pages per minute of true letter quality text — up to 10,000 per month with ease. And the graphics and text are easy on the eye.

LetterPro PLUS. Now professional quality printing is within reach of small businesses who thought they couldn't spare the money or the space for a Qume daisy wheel

printer. This compact easy-to-live with and friendly printer trots along briskly at 45 cps and is equipped with an 8K buffer memory capable of handling up to 4 pages of text. Its reliability is tested to the equivalent of two years of virtually continuous use.

Sprint 11-90 PLUS. Letterpress quality at virtually the speed of dot matrix — that's the unique performance which makes this printer the choice of a wide range of busy companies. Yet the unbeatable 90 characters per second has been achieved with no sacrifice of reliability. A rating of 5500 hours MTBF is almost a year longer than most other daisy wheel manufacturers printers regardless of speed.

Meet the whole family of letter quality printers—which also includes the Sprint 11-55 PLUS, 55-cps; the versatile Sprint 11 PLUS with 130 characters; the 11 PLUS wide-track; also the economical LetterPro 20 cps. So introduce yourself at your nearest Qume stockist, or contact us at Newbury.



▲ Laser TEN PLUS



◀ LetterPro PLUS



Sprint 11-90 PLUS ▶

Qume®

Qume Quality. Choice is just a part of it.

Marketing and Sales Qume House, Park Way, Newbury, Berkshire RG13 1EE Telephone: (0635) 31400 Telex: 846321 Telefax: (0635) 32852
Service and Training Centre Bridgewater Close, Reading, Berkshire RG3 1JT Telephone: (0734) 584646 Telex: 849706

→ circle 106 on enquiry card ←



LEGAL STATEMENTS

BY ANNE STAINES

THE DEVIL AND THE DEEP BLUE SEA

IS HOME TAPING OF PRE-RECORDED CASSETTES A CRIMINAL OFFENCE? WHATEVER THE ANSWER, IT WILL PRESENT A PROBLEM FOR THE SOFTWARE INDUSTRY.

A case soon to come before the House of Lords arises from Amstrad's marketing of three models of double-head cassette recorders. Amstrad's nationwide advertising campaign referred expressly to the machines' potential for "making a copy of your favourite cassette" at twice normal speed. The U.K. record industry claims that during the past six years it has suffered a decline in markets and employment levels of over 25 percent due almost entirely to home copying.

Amstrad was not the first manufacturer of electronic goods to cause the record companies to panic. In 1982 the Japanese manufacturer Aiwa had introduced to the U.K. a machine capable of copying both sides of a cassette tape simultaneously, at four times normal speed. Aiwa eventually succumbed to pressure from the record industry and withdrew its machines from the British market in 1984.

The record companies, represented by the British Phonographic Industry (BPI) planned to repeat this pattern of events. It wrote to Amstrad and its major distributors, alleging that the Amstrad advertising and marketing are unlawful in that they incite users of the Amstrad machines to infringe copyright in pre-recorded cassettes. What followed has been a long and often acrimonious legal dispute which is now reaching its climax. It has at various times been proclaimed as a victory for each of the industries concerned: record, electronics and blank tape.

In response to the BPI's complaint, Amstrad made a pre-emptive strike by seeking a declaration from the High Court that its marketing campaign had not been unlawful. This aspect of the litigation reached the Court of Appeal, which held that Amstrad was not liable for the civil wrong of authorising infringement of copyright. The court held that only a person in control of the relevant actions of members of the public could authorise such an infringement. Once Amstrad or its dealer sold a machine it had no control over what the public did with it.

However, Amstrad was denied the clean bill of health that it had been seeking. Since home taping might be a criminal offence, Amstrad might be guilty of inciting the commission of a crime. The crime with which the Court of Appeal was concerned is contained in section 21(3) of the Copyright Act 1956. This provision makes it an offence punishable by fines or imprisonment for anyone to have in their possession "a plate,

knowing that it is to be used for making infringing copies". The provision is set in the context of counterfeiting and offering counterfeit goods for sale or hire.

Plainly the law as drafted was never intended to refer to the practice of home taping. However, the definition of a plate includes "any . . . matrix . . . or other appliance." Although a pressed vinyl record does not fall within that definition, a pre-recorded cassette tape does. On that basis home tapers who use a double-headed machine to copy their favourite cassette commit the offence.

The BPI, drawing hope from this, is now proceeding with its own action against Amstrad. It claims that as a body for whose specific benefit the crime in s.21(3) was created, it has a right in equity to restrain its commission. The Court of Appeal recently denied this but made it plain that it regarded the law in this area as highly unsatisfactory. If the facts alleged by the BPI were true, substantial manufacturers and distributors were, on a large scale, inciting others to infringe copyright in circumstances where the copyright owners had no practical remedy. It is with this in mind that the BPI was granted leave to appeal to the House of Lords.

Computer software producers have a great interest in the outcome of this litigation. The Federation Against Software Theft (Fast) has always maintained that private copying — in the old days, of computer games by schoolchildren, nowadays of business programs in the office — is harmful to the software industry. In contrast with the BPI's view of double-head cassette recorders, however, Fast has to recognise the multiplicity of legitimate uses to which double disc drives can be put. No matter what the outcome of the BPI's case it is inconceivable that manufacturers or distributors of computers with double disc drives could be guilty per se of inciting users to commit criminal infringements of copyright.

However, it might follow from a BPI victory that every time a user made an unauthorised copy of a program using a double disc drive, he or she committed an offence. The argument would centre on whether or not a disc was a matrix within the meaning of the Copyright Act. There is no formal definition within the Act, and there have been some persuasive and time-consuming arguments on either side.

For this reason alone, Fast would be unlikely to attempt bringing the weight of the

criminal law against the users, manufacturers or distributors of computers. Add to this the difficulty of obtaining admissible evidence that a computer was used for illegal rather than some other valid purpose, and users can rest easy in their beds.

But an Amstrad defeat in the House of Lords would bode ill for the bit copier. In a recent policy statement Fast has pledged all assistance possible to software producers whose programs are copied by means of these devices. So far, "all assistance possible" has been restricted to policy statements on the evils of the bit copier.

During the course of raids on suspected counterfeiters devices such as Copywrite and Copy 2 PC have been seized, to be used as evidence of the accused's nefarious purpose. Fast might argue, in the light of a BPI victory, that in the presence of a bit copier an innocent computer with a double disc drive is transformed into a machine whose sole purpose is to infringe copyright, and that the manufacturers and distributors of these devices are guilty of inciting. The legality of bit copiers has been doubtful for some time, and Lotus's recent instruction to a distributor to withdraw copies of Unlock from sale went uncontested.

Outlawing the sale of bit copiers would directly reduce the incidence of private copying, at least of programs that are copy protected. It would also add weight to Fast's moral argument against the economic evils of casual copying.

There are some who do not find this argument convincing. It is sometimes argued, for example, that the much-needed penetration of software in British business would not take place — or at least would take place much less quickly — in the absence of private copying. According to this line of reasoning, private copying far from weakening the market for software actually stimulates it. There are no statistics to prove Fast's point, and those who drafted the Cabinet Office Green Paper on Innovation could find no evidence to support it.

Defeat for the BPI would mean a revival of interest in a royalty levy on blank cassette tape. The BPI's determination to win its case stems partly from the fact that the political tide has turned against its proposal for a levy. Fast and other bodies within the software industry deplore this potential outcome of the Amstrad trial as a licence to pirate. Whatever the outcome of this litigation for the record industry, the result for the computer industry will be either the devil or the deep blue sea. 

In a Class on its own

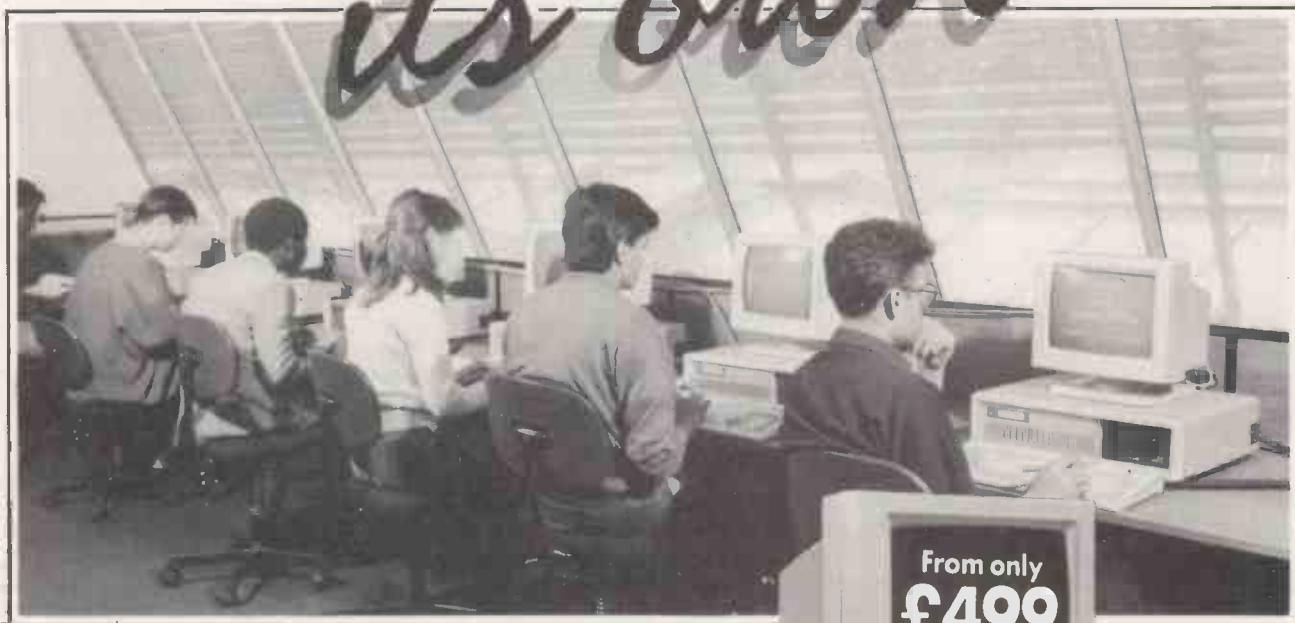

This little lot ask more of their IBM-compatibles in a day than most users demand in a year. But then this is London's Polytechnic of the South Bank, one of Britain's leading institutes of science and technology.

Here wordprocessing and data storage, financial management and computer-aided design, networking and terminal emulation are all in a day's work.

So you can be sure that when the Polytechnic chose the PC II Turbo from Opus—almost 200 of them in fact—it was only after a great deal of study.

Even with a starting price of £499 the PC II Turbo faced some cheaper competitors but, when it came to speed, compatibility and expandibility, it proved to be in a class of its own. Now it's in every class from electronic engineering to administrative studies and from computer services to humanities and social sciences.

With its NEC V20 processor the PC II Turbo is up to three times as fast as the IBM PC/XT and its switchable from 4.77 to 8 MHz Turbo processing at the flick of a keyboard. You can choose high resolution monochrome, colour or EGA systems, single or dual disc drives, 1 Megabyte RAM expansion or 20 Megabyte Winchester. And if you think our options could teach the competition a lesson or two, you'll find the PC II Turbo's standard features a real education.

- NEC V20 Super Processor ● 360K Floppy Disk Drive
- Hercules-compatible Graphics Card ● High Resolution
- Monochrome Monitor ● Quality AT-Style keyboard
- Highly Compatible BIOS ● 256K of RAM Expandable to 1 Mb creating 384K RAM disk ● 8 Expansion Slots
- Keyboard Security Lock ● Parallel Printer and Joystick Interfaces ● Real Time Clock/Calendar with Battery Back-Up ● 150 Watt UL-Approved Power Supply
- Comprehensive User Manual ● 12-Month Guarantee.



Should you need more than our 12-month free warranty, we'll even offer you a low-cost on-site maintenance option.

Like South Bank Polytechnic we're sure you'll take a close look at the competition, their options and availability. When you have, call Opus on **0737 65080** and hear about our guaranteed 72-hour delivery. We offer special education and government discounts and welcome dealer and export enquiries. Price quoted exclusive of VAT and carriage.

PC II TURBO

Opus Supplies Ltd,
55 Ormside Way,
Holmethorpe Industrial Estate,
Redhill, SURREY RH1 2LW.

Opus.

IBM is a trademark of International Business Machines Corporation.

GRAPHICS ON CLONES

Q I recently bought an AST Sixpak Plus memory board with 384K RAM. My problem is that I get an error message Parity Check 2. I switched parity checking off to try to sort out the problem, and got a message indicating that the fifth chip on the first bank of memory on the Sixpak had failed. I have replaced it several times with seven other chips, but still get error messages. Please can you help?

P SOEGIHARTO

A The solution to your problem should be quite straightforward. The IBM will give a parity error when checking the memory at boot-up time not only if a chip is really faulty but also if it tries to read or write to a memory address that does not contain a memory chip. For example, if you set the switches for a total of 512K memory in the machine but only have 256K there, then you get a parity error from the first bank of memory tested above 256K. You get the same error if you have memory chips present but have a hole in the address map through wrong switch settings.

The PC must be told the exact amount of memory installed in the machine. In your case this is the 256K on the motherboard plus the 384K on the Sixpak, giving a total of 640K. This is done by setting the switches on the SW2 block of switches on the motherboard. There are eight switched on this block, and you must set the first five to indicate the memory present. For 640K memory on a system like yours, S1, S3 and S4 should be On; S2 and S5 should be Off. Check the Sixpak manual for the setting on the memory board itself.

Q I run a bulletin board system with an Advance 86 computer. It has now filled up both floppies so I am after a RAM disc and a hard disc. I have tried many memory boards and found that you need modifications to the

Q At work I use a monochrome IBM PC/AT fitted with a Hercules card. I have written several short Basic routines that display menus and the like, some of which make use of high-resolution graphics. To allow me to do some work at home I have recently acquired a Qubic PC clone to which I have added a clock/calendar card.

In most respects the new machine performs very well, but I rapidly discovered that IBM's Basic would not work. I then tried GWBasic and DOS 2.11 for a Tandy Model 1000: though simple Basic commands work I have been unable to get any of the high-resolution graphics to work, either with DOS 2.11 or with Qubic's DOS 3.1. The Tandy 3000's DOS/Basic and Victor VBasic and MSBasic are also no good. With a genuine Hercules board I can get high-resolution graphics, but only when I use Hercules's Graphx language, which is not remotely like IBM's, or Tandy's, or anyone else's. How can I get programs that use commands such as Draw, Line, Circle and Paint that work fine on the IBM to work on my clone?

MICHAEL EARLEY

A There must be many thousands of users who have bought IBM clones fitted with Hercules-type screen adaptors, together with Basic or GWBasic. The Hercules screen adaptor has the advantage of better screen resolution and clearer text characters on the 720-by-348-dot screen, but graphics commands that work fine with the standard IBM Monochrome Display Adaptor's 640-by-200 screen simply do not work with the different screen resolutions used by Hercules, or with the Enhanced Graphics Adaptor (EGA) for that matter. The graphics commands assume the standard IBM screen and will not work with a different screen display. True IBM computers have two different versions of Basic configured for the normal and the Hercules screens, but since part of IBM Basic is stored in a ROM and the clones do not have this ROM, then the IBM versions of Basic will not work on clones. The Basic software is written for one particular type of screen.

Writers of software for mainframe computers went through this sort of mess years ago. Instead of writing software that worked with one particular machine or environment, and having to rewrite it for another machine, they solved the problem by writing software that will work with any device so long as a device driver is written to take advantage of any special features, and to allow for peculiarities in that device. It is sad that writers of micro software have not yet copied this idea.

So what solutions are there to your present problem? Plainly you need a new version of Basic for the clone, and the cheapest option is probably to buy the QuickBasic compiler. Like Basic, QuickBasic is written by Microsoft, and it is almost — but not quite — compatible with Basic. QuickBasic should work with both the standard IBM screen and the Hercules screen.

Remember that QuickBasic is a compiler, whereas Basic is an interpreter. Programs will run very much faster with QuickBasic, but it is a lot harder to debug programs with a compiler. For example, you can no longer use Tron and Troff with Basic to trace what is happening line by line while you are developing a program.

Another solution is to use MBasic. It was originally written by Microsoft for eight-bit CP/M machines, but when it was rewritten for 16-bit machines a set of graphics commands were added. The problem is that this software is very expensive.

It could well be that in the long run you would be better off using another language, such as Turbo Pascal, that can handle problems like different screen formats much more easily. This plainly involves a significant investment in time, both to learn the new language and to recode your programs.

As part of the purchase price of its PC clones, Ferranti supplies versions of Basic for both the normal IBM screen and the Hercules screen. Clearly it is too late to change your machine now, and your story highlights the need to get good advice before rather than after buying.



system board. I have an old model, and have tried the original BIOS chip, the FX-5 and the FX-6 chip — but no luck. I would be grateful for any information you could send to me.

J BROOKS

A If your Advance has a serial number of 14000 or higher the motherboard and BIOS will have been modified and you should be able to

get a wide variety of memory boards to expand the total memory from the 256K on the motherboard up to a maximum of 640K. There were problems with earlier machines, and we have some details if you are technically inclined.

The extra memory board could be a multi-function board providing a clock with battery backup so that you do not need to type the date and time

every time you boot up. It could have extra serial and/or parallel ports as well. These IBM-type boards plug into the usual expansion slots, but since they address the memory on the extra board as eight-bit memory, whereas that on the motherboard is addressed as 16-bit memory, the expansion board will run more slowly. Ferranti makes a 16-bit memory board that works at full speed. RAM disc software is usually provided when you buy a new memory board.

There are problems fitting a hard disc to an Advance. First, the power supply may not be sufficient to provide the extra current needed to drive the hard disc itself. Check this carefully before you buy. Secondly, many hard-disc kits for the IBM PC have a PROM on the controller board that requires that the IBM ROM BIOS be present on the motherboard. This means that they will not work on the clones. One firm that can supply hard disc kits or PROMS that work on these machines is Microbe Computer Systems, PO Box 1, Wray, Lancaster LA2 8RF; telephone (0468) 62333.

Finally, there is an Advance and Ferranti User Group, run by Charles Prince, 125 St. James Avenue, Thorpe Bay, Southend-on-Sea, Essex SS1 3LW; telephone (0702) 588655. 

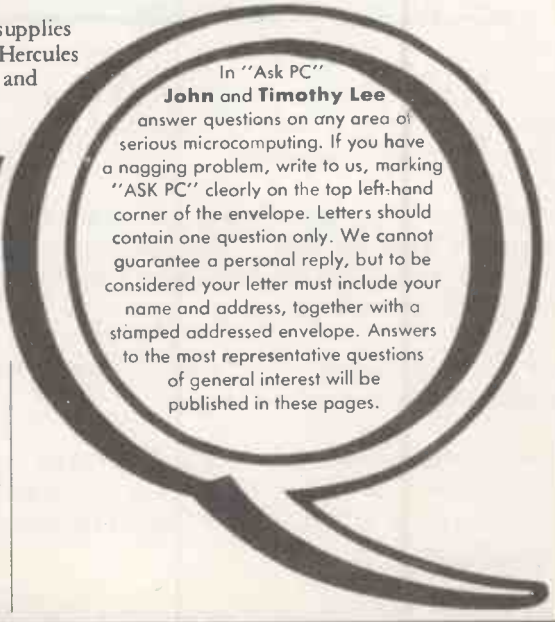

In "Ask PC"
John and Timothy Lee
answer questions on any area of serious microcomputing. If you have a nagging problem, write to us, marking "ASK PC" clearly on the top left-hand corner of the envelope. Letters should contain one question only. We cannot guarantee a personal reply, but to be considered your letter must include your name and address, together with a stamped addressed envelope. Answers to the most representative questions of general interest will be published in these pages.

Choose Walters and you're in business

£455

WALTERS PC/XT

Standard model. Price includes:-

- CPU 8088/clock speed 4.77 MHz
- 8-slot motherboard
- 256k memory expandable to 640k on board
- 360k floppy disk drive
- floppy disk controller
- keyboard
- mono monitor
- mono card

Spec as above with 20 mbytes Winchester **£875**

Spec as above with 30 mbytes Winchester **£1235**

Spec as above with 40 mbytes Winchester **£1675**

Spec as above with 80 mbytes Winchester **£1855**



£555

WALTERS TURBO PC/XT WITH HIGH RESOLUTION GRAPHICS

Turbo model. Price includes:-

- CPU 8088/clock speed 4.77 MHz/8 MHz
- 8-slot motherboard
- 256k memory expandable to 640k
- 360k floppy disk drive
- floppy disk controller
- keyboard
- mono monitor
- high resolution mono and parallel printer card

Spec as above with 20 mbytes Winchester **£975**

Spec as above with 30 mbytes Winchester **£1335**

Spec as above with 40 mbytes Winchester **£1775**

Spec as above with 80 mbytes Winchester **£1955**

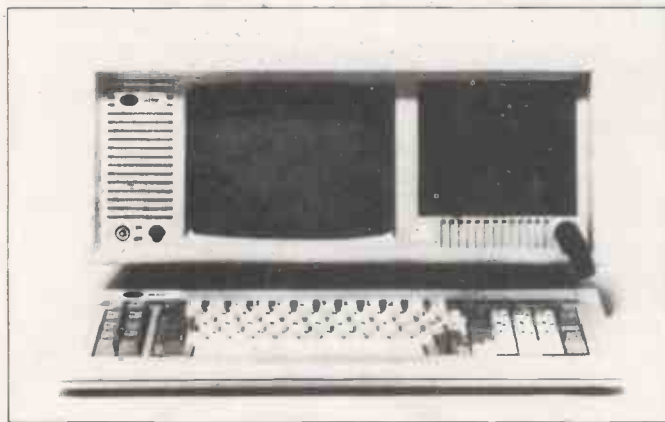

£650

WALTERS PC/XT PORTABLE

Portable. Price includes:-

- CPU 8088/clock speed 4.77/8 MHz
- 7-slot motherboard
- 256k memory
- 360k floppy disk drive
- floppy disk controller
- keyboard
- 9" integral mono monitor
- high resolution mono and parallel printer card

Spec as above with 10 mbytes Winchester **£934**

Spec as above with 20 mbytes Winchester **£1070**

Walters' machines have a 12-month warranty. An optional 2-year maintenance contract is available for 12% of the system cost. Walters International is licensed to sell MS-DOS. It is available, together with GW-Basic, for £60 plus VAT.

If you're in business and looking for an XT compatible, you'll want a machine that is not only very competitively priced, but also highly IBM compatible.

You'll be looking for something with the potential to expand and the ability to accommodate a wide range of add-ons. Perhaps you'll also be searching for a machine that will fit into a PC network.

And you'll want to buy from a reliable, well-established company that knows the marketplace.

Then you really should be looking at the Walters International PC/XT range. Walters was one of the first manufacturers to sell low-cost IBM clones and is now a market leader.

Ring Walters for further information today or send off the coupon and you could be in business.



WALTERS INTERNATIONAL IS AN IBM™ PATENT LICENSEE

I would like to find out more about PC compatibles from Walters International

Name

Company

Job Title

Address

Please send to:
Walters International Ltd., Matrix House, Cressex Industrial Estate,
High Wycombe, Bucks HP12 3RD.
Tel: (0494) 32751-9. Telex: 838882 MATRIX G. Fax: (0494) 33757

PC16/87

"PLUG IN AND GO!" A NEW BREED OF MULTI-USER COMPUTER

Concurrent
DOS/XM
standard



The Bromcom QC is a totally new breed of computer, achieving tremendous breakthroughs in price, size and ease of use. A highly versatile four user multi-tasking computer capable of expansion to much larger configurations; the Bromcom QC also acts as a file server to any IBM PC, the new Amstrad PC and most clones.

HALF THE PRICE!

Accustomed to high prices for multi-user systems? The Bromcom QC is under half the price of traditional multi-user systems and is cheaper, per user, than many PC's. But the Bromcom QC doesn't cut corners — 20MB hard disc, full 16 bit processor (running at 10MHz) and 1MB of RAM are standard; 2 or 4 MB RAM memory, 40 or 80 MB hard disk options are now available. Four high specification VDUs, cables and FREE user-menu, diary and electronic mail software complete the package. And all for half the price of a traditional multi-user system.

QUARTER THE SIZE!

Are computers taking over your office? The Bromcom QC is "shoebox" size — making it the smallest and most attractive multi-user computer ever.

PLUG IN AND GO!

Yes it's true! Simply plug in and switch on. User menus ensure even the most inexperienced of computer users get the most from the Bromcom QC.

NETWORKING!



The Bromcom QC is the first system specifically designed to act as a file server to the Amstrad PC and is also an ideal file server for IBM, Olivetti, Ericsson and a host of other PC's.

subject to available RAM — 2 and 4 MB RAM options are available.

BETTER MULTI-USER COMPUTING

The Bromcom QC allows you to do four things at once! By using Digital Research's Concurrent DOS/XM operating software, any of the four users can run four* programmes *simultaneously*. That's 16 tasks in all. And you can change from doing one task to another instantly, at the touch of a single key. Because Concurrent DOS runs almost all CP/M and MS DOS programmes there's no shortage of software to choose from. You can run Pegasus, Omicron, Wordstar, Supercalc, Sensible Solution, Dataflex, Tas and many, many others.

BETTER EXPANDABILITY

The Bromcom QC has numerous options for add-on expansion:



- industry standard ARC-Net networking
- 4 extra serial synchronous/asynchronous ports
- 40 or 80 MB Winchester option (instead of 20)
- 40, 80, 150 or 200 MB Winchester add on
- 20 or 45 MB tape backup subsystem
- 2 or 4 MB RAM option (instead of 1 MB)

BETTER FOR YOU

Bromcom QC's are great for any size of business. In small companies a QC can handle all data and word processing activities in one, easy to use, machine. In larger companies and institutions, a QC makes an ideal departmental unit or for communication between departments. Only a few of the software packages available for the Bromcom QC are listed above — there are over 1000 other possible applications.

The Bromcom QC really is the natural progression from the PC. For further details, or for demonstrations, contact us today.

BROMCOM QC
THE BEST IDEA SINCE THE PC

Bromcom Computers Limited, 417-421 Bromley Road, Downham, Bromley,
Kent BR1 4PJ, England. Telephone: 01-461 3993 Telex: 926012 BC0M G

→ circle 109 on enquiry card ←

DEC MICROVAX 2000

THE MINI MINI

By Steve Malone

The youngest member of DEC's microcomputer family is much smaller than most desk-top micros.

Until recently, the Digital Equipment Company (DEC) made its arch rival IBM seem left footed by comparison. While it has continued to dominate the minicomputer market, it has also threatened to take on IBM at the mainframe end with the powerful Vaxcluster concept. And rather than taking quixotic charges at the IBM industry standard for micros, DEC has fallen in with the Vaxmate. Like Apple, it has decided to concentrate on areas which it does best and have not yet been dominated by an IBM-defined standard.

This is where the Microvax 2000 comes in. The blank refusal of IBM to make available some kind of office multi-user microcomputer system has left the market wide open. It also happens to be an area where there was a gap in the DEC range. The requirement is for a multi-user micro for a small number of people which could be hooked into the large DEC minis. A machine of this capacity would allow distributed departmental processing which would not be a burden on the main system yet could be managed effectively by the data-processing department.

The Microvax 2000 is a very small beast indeed. Measuring just 285mm. by 320mm. by 175mm. for the basic unit, it is not much more than a quarter of the size of the standard AT box. Inside you get the same DEC 32-bit chip set that powers the 2000's elder sibling, the DEC Microvax II. You also get 4Mbyte of RAM as standard, expandable to 6Mbyte, although the machine we saw was a prototype with only 3Mbyte of memory.

There are two basic models in the range. The first has a 42Mbyte half-height hard disc plus a 1.2Mbyte floppy-disc drive for backups and data storage. The other model contains a full-height 71Mbyte hard-disc drive and no floppy. The prospect of having only a hard disc might seem odd to the PC user, but it makes a lot of sense in the DEC universe. DEC views the Microvax 2000 as a machine mostly for its existing users or for people who wish to install a company-wide DEC-based system. The micro is expected to form part of a cluster or a network, with information downloaded from a Vax 8000 supermini or some other species of DEC kit. External storage devices are available for

the 71Mbyte hard-disc version if you need them. The machine we saw was sitting on top of an identical-sized box which contained a tape streamer. There is also to be a range of disc units available. The mass-storage unit and the Microvax 2000 are connected via a parallel interface of DEC's own design. Another fast interface is fitted on to the Microvax 2000 for an add-on disc drive. Among the other interfaces are a power input unit, a coaxial bayonet socket for connection to a network, and four inputs for terminals.

There are two types of terminal input. The first is a single 25-way RS-232 interface in the top right-hand corner. The other three terminal sockets are RS-423 sockets of the telephone-jack type mounted on a box on the back of the unit. When all four sockets are being used the one fitted to the RS-232 interface acts as the master terminal.

One of DEC's VT-220 terminals was connected to the machine we used; this is the advanced type now on offer across the DEC range. It has a monochrome screen and a keyboard identical to that supplied with the Vaxmate. The back of the terminal has an RS-232 interface to connect it to the system unit. It also has an RS-422 interface to allow a local serial printer to be fitted.

The keyboard bears a passing resemblance to the latest IBM model, as fitted to the Personal System/2 range. It has the function keys running along the top, and separate cursor-control and numeric keypads. The DEC keyboard has a total of 20 function keys, but keys f15 and f16 are not marked as such; instead they are renamed Help and Do respectively. Many of the attributes of the

function keys are retained through a range of applications and perform general requests to the system. Thus f1 freezes a screen, so that you can read a document as it scrolls past you. The f2 key prints the screen, and f3 allows you to change the configuration of the terminal.

The terminal was originally configured as a 9,600 baud VT-220 device, but after a few tries we reverted to configuring the terminal as a VT-100, which we found easier to use than its more advanced counterpart. To maintain performance we altered the transmission rate from 300 baud to the VT-220's 9,600 baud.

One of the big selling points of DEC equipment has been the Vax/VMS virtual-memory operating system. Ever since the earliest PDP models, the company has been able to offer users a reasonably smooth upgrade path which allowed programs and data to be ported from one machine to another without modification. The success of this philosophy has not escaped IBM, which is in the process of developing its own version of the VMS software interface known as Systems Application Architecture (SAA).

BUFFER

VMS scores by creating a buffer between the hardware and the application. Programs are written to use the hooks within VMS; they do not address the hardware directly. This happy state of affairs means that DEC can change almost any piece of hardware — even the processor — and previously written applications will run oblivious to the changes.

Programs can be downloaded from the mighty Vax 8200 and run on the humble Microvax 2000. This is obviously a boon to data-processing departments. They can keep a copy of a program on their central machine, to be updated and amended when the need arises. Yet it can be transferred to smaller departments the instant they require it. This is in contrast to many applications in the IBM universe, which have to be altered radically for each machine.

VMS is a multi-user, multi-tasking operating system which resembles Unix, with a similar system of tree-structured directories and virtual-memory management. Perhaps aware of the rather arcane structures of Unix, DEC has made many of the VMS commands, a little more friendly. This is especially true of those commands, such as Copy and Mail, which are likely to be run by users who are not professional Vax programmers.

SPECIFICATION

CPU: proprietary DEC CPU and floating-point processor

RAM: 4Mbyte, expandable to 6Mbyte

Mass storage: 1.2Mbyte floppy disc and 42Mbyte hard disc; optional external floppy-disc, hard-disc and tape backup modules

Interfaces: one RS-232C, three RS-423 telephone-jack serial ports, two proprietary DEC expansion buses, Ethernet port

Price: £7,511; 71Mbyte hard-disc model £11,900; terminals not included; four-user VMS licence £2,080

U.K. distributor: DEC Customer Services Centre, Jays Close, Basingstoke, Hampshire RG21 4BS. Telephone: (0256) 56101

Available: now



Many commands have extra prompts to take you through the various parameters required before execution. For example, to send a message to another terminal you type Mail to enter the appropriate program and then type Send. The program will ask you for the target name, followed by the subject. You can then type in your message, and you finish by pressing Ctrl-Z. The incoming message is immediately flagged on the target console. If you get stuck there is on-line help available at all times.

As well as accessing the directly addressable RAM found in the Microvax and its cousins, the operating system is able to utilise what DEC calls paged memory — more commonly known as virtual memory. The system utilises the full 4Gbyte capacity of the 32-bit processor by treating the hard disc as a bank of expanded memory. When data in the virtual memory is required it is swapped or paged with memory in RAM and used directly by the processor.

Of course, not everyone will have 4Gbyte of disc space attached directly to their micro, but here the Vaxcluster concept that is built into the DEC architecture comes into play. The Microvax can be used in a Local Area Vaxcluster, which is a smaller version of the

cluster system that DEC has been using for many years.

The idea of a cluster is that the computers attached to it not only exchange information, but also utilise each other's disc capacity and processors. It means that if one processor runs out of virtual memory or is performing a particularly time-consuming task it can call on the assistance of the other processors on the cluster. It is this facility which enables the Vax minis to challenge the power of mainframe computers.

In the case of the Microvax 2000 it means that the micro is not limited to its own 42Mbyte storage capacity and processor but can use that of its partners in the cluster. Up to 13 satellite nodes can be connected together in a Local Area Cluster. During initialisation each machine seeks out the other members of the cluster and informs them of its presence. The Microvax can then draw on the power of the other members.

It is impossible to make a general comparison between the Microvax 2000 and PC-type machines. Like most other multi-user systems it lacks the kind of high-resolution graphics to which micro users have become accustomed. The deluge of PC programs are also not available, but the DEC

range has a healthy software base in its own right. The 32-bit DEC processor chip is not burdened by distinctions of Real, Protected and Virtual modes, and so is very fast.

VMS is not well known outside the mini-computer arena, so if a simple multi-user micro system is all you need you would probably be better off with a fast AT or 80386-based machine adapted for multi-user operation. But if your requirements are for a number of such machines connected together, the Microvax 2000 is certainly worth a look, because of its clustering capabilities. Finally, if your business already uses other DEC equipment, there is really no contest.

CONCLUSIONS

- The Microvax 2000 is a departmental micro able to service the needs of up to four people.
- DEC has continued the philosophy of compatibility across its range, which means that the Microvax 2000 can run the same programs as the Vax 8000 superminis.
- The Local Area Vaxcluster allows several machines to share their workload.
- The Microvax 2000 should allow DP managers to react quickly to the changing office environment by bringing in low-cost compatible equipment for small work groups. **XT**

TWICE AS SHARP



DISTRIBUTED THROUGH 

SHARP

▲ COMPUTERS ▲



A NEW AGE OF PORTABLE COMPUTERS,
WITH ADVANCED DISPLAY TECHNOLOGY.

Note: THE 7100 AND 7000A
PERSONAL COMPUTERS.

TWO IN THE RANGE OF COMPACT TRANS-
PORTABLES, WITH THE SOPHISTICATED OF
DESK-TOP COMPUTERS. IBM COMPATIBLE.
HIGH CONTRAST SUPER TWIST L.C.D.
ELECTRO LUMINESCENT BACKLIGHTING.
FOR ENHANCED IMAGE QUALITY. PC 7100
DESIGNED WITH BUILT-IN 20MB HARD
DISK DRIVE AND 5¼" FLOPPY. HIGH SPEED
OPERATION. LARGE SCALE APPLICATION.
BROAD SYSTEM EXPANDABILITY. MULTI-
FEATURED FLEXIBILITY. THE BEST OF BOTH
WORLDS. CLEAR AND SHARP

All enquiries to: MR. A. FALL, NATIONAL SALES MANAGER,
SHARP BUSINESS EQUIPMENT DIVISION, SHARP HOUSE,
THORP ROAD, NEWTON HEATH, MANCHESTER M10 9BE.

Name _____

Company _____

Address _____

Postcode _____ *Tel:* _____

PC2

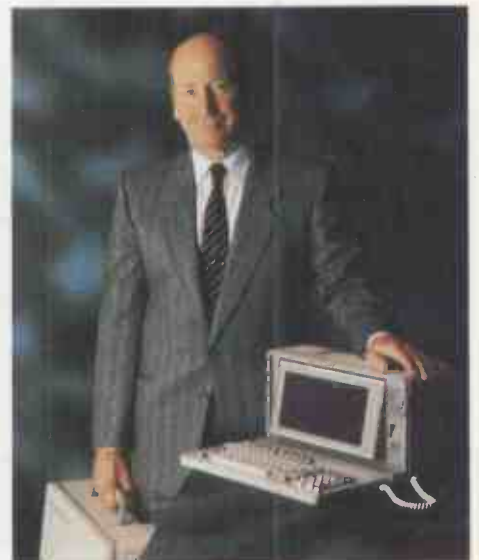

→ circle 110 on enquiry card ←

FOR PEOPLE WHO MEAN BUSINESS

KAYPRO 386

THE FIRST 386 CLONE?

By Steve Malone

A dozen or more 80386-based AT-compatible micros have appeared in the six months since Compaq started the ball rolling. Kaypro's new machine is among the latest arrivals aiming to make the most of the period before IBM's Personal System/2 gains a stranglehold.

Listen hard and you might hear a distant rumble. It is the sound of manufacturers stampeding to bring out an 80386-based AT compatible. Each month brings a rush of new launches featuring the wonder chip and its sidekick the 32-bit bus. Kaypro is among the latest to send its dreadnought down the slipway into the cold corporate ocean.

At the press conference to launch the Kaypro 386 Andrew Kay, the company chairman, said the machine was being unveiled now because Kaypro was among the last to enter the IBM-compatible market and had perhaps suffered as a result. Obviously the company did not want to get left behind again.

Kaypro has promised five models, of which three were announced at the time of writing. The Model A is the entry-level machine, fitted with a single floppy disc and 512K of RAM. The next level up is the Model E, which is characterised by Kaypro as the power-user specification. It has 2.5Mbyte of RAM and a 40Mbyte hard disc. The final model in the range is the Model N, which is intended to act as a file server for Kaypro's proprietary version of Novell's Netware. It comes with a choice of 150Mbyte, 240Mbyte or 330Mbyte hard discs.

The machine we were sent for the review was actually none of these. It was an early version intended mostly for reviews and demonstrations, and was fitted with a 30Mbyte hard disc and 512K of memory. But apart from that, it is the machine that will be reaching the dealers.

From the outside the Kaypro 386 looks identical to the 286 as the two machines are built into the same casing. Only the badge betrays the difference. It has the standard clone features, including the key-lock — though this feature seems to be falling from favour with other compatible manufacturers — and the power and hard disc LEDs on the right-hand side of the machine. On the far right is a half-height 5.25in. 1.2Mbyte NEC floppy-disc drive. Underneath it are slots for a further two half-height devices.

The keyboard conforms to the latest IBM standard, as now found on AT machines, for example. It has 12 function keys along the

top, a numeric keypad and separate clusters for the cursor-control keys and other standard function keys. Apart from the temporary nuisance of having to relearn where the Escape and other control keys are located I found it pleasant to use, and certainly an improvement on Kaypro's previous efforts. One oddity is an orphan key in the bottom left-hand corner marked Macro. No one at Kaypro had any idea what the key was for, but no doubt we shall find out eventually.

The keyboard has a good long cable leading round to a socket at the back of the machine. Also at the back are the parallel printer and serial ports. Unlike most other manufacturers Kaypro has mounted these sockets vertically, so they look as if they are on an expansion card, though this is not in

will not accept 16-bit ones. In addition to this physical incompatibility Kaypro has incorporated an electronic lock on the 32-bit bus which will prevent a standard 16-bit card from being installed.

With the introduction of its own Micro Channel 32-bit bus IBM has cut the ground from underneath Kaypro and its ilk. At the very least it means that the Kaypro bus will have a somewhat restricted existence. Kaypro may decide to support it with its own products, but it is not likely to be supported by anyone else. In the short term, Kaypro might make sales to those requiring a souped-up AT in a hurry, but eventually the bus will have to be replaced by a licensed or reverse-engineered Micro Channel. The same applies to 32-bit buses from other manufacturers.

Two of the 16-bit slots were occupied on the review machine. One was used by a Kaypro EGA video card and another contained a Western Digital disc-controller card that handles both floppy and hard discs. The motherboard design is a joint development between Kaypro and Intel, and uses surface-mount technology. The board on our machine was built by Intel, but volume production will be undertaken at Kaypro's own plant. The motherboard on our machine certainly looked like a quick and dirty job, with jumper leads snaking around all over the place. Whoever designed it did not seem to have the convenience of the end-user in mind. The 80387 maths co-processor socket is positioned underneath the power transformer, and it looked as though you would have to dismantle the power supply to get at it.

The 80386 processor is clocked to run at 16MHz. Phoenix's 386 BIOS ROM is fitted to maintain IBM compatibility. On the basic Model A machine 512K of RAM is built into the motherboard. The extra 2Mbyte on the expanded Models E and N is mounted on a single card which occupies one of the 32-bit slots. All of the expansion slots will run at 16MHz. To prevent any compatibility problems arising from expansion cards which expect a lower clock speed wait states have been introduced into the system. You can alter the clock speed from the keyboard by pressing Ctrl, Alt and the numeric keys 1

KAYPRO 386				
VERDICT				
	POOR	AVERAGE	GOOD	EXCELLENT
Performance	<input type="checkbox"/>	<input checked="" type="checkbox"/>	<input type="checkbox"/>	<input type="checkbox"/>
Ease of use	<input type="checkbox"/>	<input type="checkbox"/>	<input checked="" type="checkbox"/>	<input type="checkbox"/>
Documentation	<input type="checkbox"/>	<input type="checkbox"/>	<input type="checkbox"/>	<input type="checkbox"/>
Value for money	<input type="checkbox"/>	<input type="checkbox"/>	<input checked="" type="checkbox"/>	<input type="checkbox"/>

Perhaps Kaypro is being a little too hasty.

fact the case. The sockets are connected to ribbon cables which run down on to the motherboard.

The Kaypro 386 has eight full-length expansion slots. Two are eight-bit slots and four are of the 16-bit variety. For the remaining two slots the company has taken the plunge and provided 32-bit buses. They conform to Intel's own 32-bit specification, but do not appear to be compatible with IBM's eight-bit and 16-bit cards. As anyone who has taken a look inside an AT is aware, the 16-bit IBM expansion slots are divided into two, so that you can put an eight-bit card into a 16-bit slot if necessary. The Kaypro 32-bit slots are built differently, and while they will accept an eight-bit card they

(continued on page 49)

SPECIFICATION

CPU: 80386 running at 16MHz; socket for 80387 maths co-processor

RAM: 512K, expandable to 16Mbyte; Model E and Model N have 2.5Mbyte

Dimensions: 165mm. (6.5in.) x 420mm. (16.5in.) x 520mm.(20.5in.)

Mass storage: one 1.2Mbyte 5.25in. floppy-disc drive, with option of two other front-loading devices; Model E has 40Mbyte, 82Mbyte or 130Mbyte hard disc; Model N has 150Mbyte, 240Mbyte or 330Mbyte hard disc

Interfaces: one RS-232 port and one parallel printer port

Display: none, Kaypro EGA card fitted as standard to Models E and N

Keyboard: 103-key new-style AT-compatible keyboard fitted with 12 function keys, numeric keypad and separate cursor-control keys

Prices: Model A £3,699; Model E from £4,839

Software in price: MS-DOS 3.21, Quarterdeck Desqview

Manufacturer: made in the U.S. by Kaypro Corporation of Solana Beach, California

U.K. distributor: Kaypro U.K., Osnaburgh Studios, 46-48 Osnaburgh Street, London NW1 3ND. Telephone: 01-387 5530

Available: now



Kaypro has provided three slots to link with its proprietary 32-bit bus. Eight-bit cards will fit but 16-bit AT cards will not.



The slimline tonic for your office

As the UK's leading laser printer specialists, you'd expect Mekom to bring new and exciting models to the marketplace.

With the stylish new Canon LBP-8 Mark II you won't be disappointed.

It's the ultimate combination of innovative design, advanced technology and real ease of use.

The new slimline, lightweight laser maintains the true Canon hallmarks of quality and high performance. And now with added sparkle.

There's more resident fonts; two font

cartridge slots; twice the paper capacity; a new LCD display; and PRINTILITY™, a unique software utility to give access to additional emulations and extensive graphics facilities.

And because it's supplied by Mekom – we've now installed over 2,000 Canon lasers already – you can be sure the new LBP-8 Mark II will be fully compatible with your existing systems.

We think you're going to like the refreshing new style of the Canon. Contact Mekom today to find out how easily the slimline Mark II will fit into your office plans.

Your local office is shown below.



...the new Canon LBP-8 Mark II Laser printer.

MEKOM

Computer Products Limited

Head Office and Midlands Region,
Enfield Hall, Enfield Road, Edgbaston,
Birmingham B15 1QA Telephone: 021-454 2288

Northern Region
850 Birchwood Boulevard, Birchwood, Warrington,
Cheshire WA3 9QZ Telephone: 0925-821776

Southern Region
Giltspur House, 6 Giltspur Street, London EC1A 9DE
Telephone: 01-248 1711

LEADERS IN LASERS

Please complete and return to: Mekom Computer Products Ltd.,
Enfield Hall, Enfield Road, Edgbaston, Birmingham B15 1QA.

Please send me details of the new Canon LBP-8 Mark II

Please call me to arrange a free, no strings
attached demonstration of the Canon LBP-8 Mark II

Please send me details of other Mekom products and services

Name _____

Position _____

Company _____

Address _____

_____ Telephone _____

Printer currently used _____

(continued from page 47)

or 2 to set the speed to 8MHz or 16MHz respectively.

Kaypro says it has not implemented any of the high-speed memory tricks employed by its rivals, and ordinary dynamic RAM chips are used throughout. This is curious for an 80386 card built by Intel, as the company recommends that a 64K high-speed RAM cache should be used to optimise performance.

No circuitry is provided to support any of the standard expanded-memory specifications, so there is no access to the extended memory under MS-DOS, other than as a RAM disc. However, Kaypro is bundling Quarterdeck Office Systems' Desqview control program with the 386. It does not permit direct access to the 2.5Mbyte of memory, but it will allow several programs to run concurrently.

HARDWARE COMPATIBILITY

As part of the compatibility testing of the machine we installed a Vega Deluxe EGA card and a 20Mbyte Mountain Drivecard lent to us by P&P Micro. Both of these cards worked with no problems at all, which was just as well because we had some difficulty with Kaypro's own display card.

The Kaypro EGA card is supplied as standard with the Model E and Model N versions. In EGA mode we found that Lotus 1-2-3 and Microsoft Word would not recognise that the video card supported graphics. The effect was that when Lotus graphics or

Word were run, the screen blanked out and the machine hung up. When Word was run in Character mode it ran without difficulties. The Vega card ran Word in graphics mode with no problems.

We made several phone calls to Kaypro about this problem. The best anyone could come up with was to alter a DIP switch setting, which had the effect of running the EGA in Colour Graphics Adaptor (CGA) mode. This is hardly a satisfactory solution, as people want to run enhanced graphics on an EGA adaptor, not the inferior CGA-standard colour graphics. To be fair, the team at Kaypro's U.K. office had not yet received all the documentation on the machine; they may well be able to come up with a better solution in the future. The curious thing is that the Kaypro and Vega cards use almost identical chip sets from Chips and Technology. It should work, but it didn't.

The faulty EGA card made a nonsense of any software compatibility tests. Though Word ran satisfactorily in CGA mode Lotus 1-2-3 graphics did not. The screen simply blanked out, just as it did in EGA mode, and the system locked up, making it impossible even to return to the worksheet. We finally did get the Lotus graphics to work on the Kaypro 386, but only after replacing the Kaypro EGA card with a standard IBM card. Microsoft Flight Simulator simply hung up, even when we replaced the EGA card. Curiously, Sidekick worked in Kaypro's EGA and CGA emulation modes. Perhaps

the program is not as fussy as we sometimes think.

We turned finally to the benchmarks. The Norton SI rating for the computer comes out at 18.7, which is about normal for a 16MHz 80386-based machine. This figure falls to 15.3 when the clock speed is cut back to 8MHz. The Basic Benchmarks came in at 2.03 seconds, which leaves the Kaypro 386 about one-tenth of a second behind the Compaq Deskpro 386. For the record the 30Mbyte Seagate hard disc fitted to the review machine turned in a nippy 59.2 seconds running the Bagshaw Disc Benchmarks; production machines will be fitted with a different unit. However, the 1.2Mbyte floppy-disc drive took 764 seconds, which puts it among the slowest 1.2Mbyte floppies we have encountered.

CONCLUSIONS

■ Kaypro is one of the latest companies to launch an AT-compatible 80386-based machine.

■ The announcement by IBM of its own 32-bit bus means that these machines do not have much of a future except as souped-up AT clones.

■ The review machine showed signs of having been put together in a hurry, but for the most part it does appear to work.

■ What does not work is the Kaypro EGA card, which would be a major liability if sent out in its present condition.

■ The machine reminds us all for the world of an 80386-based Taiwanese clone: solid, reliable for the most part, and just a little dull. **PC**

MIR MICRO-RENT

MICRO-RENT DO MORE!

MAC-PLUS



TANDON



H-P LASERJET

£58 PER WEEK*

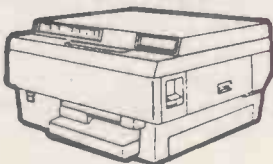

IBM PC AT



Micro-Rent do more than offer you the best rental deals on microcomputers. They rent printers, hard-disk systems, monitors - even some software!

Micro-Rent - the complete rental service - saves you time and money, and solves your problems fast.

Buying? Ex-rental machines often available at reduced prices.

AND NOW - FAX MACHINE RENTAL FROM £40 PER WEEK!

Ring for details

01-700 4848

MIR
MICRO-RENT

St. Marks Studios, Chillingworth Road, London, N7

APPLE · APRICOT · IBM PC & XT · OLIVETTI
MACINTOSH · TANDON · SIRIUS · COMPAQ
LASER PRINTERS · DESK-TOP PUBLISHING

*Prices quoted are based on 3-month rental, excluding VAT.

→ circle 111 on enquiry card ←

→ circle 112 on enquiry card ←

LASERJET II

TWO CHEERS FOR HP

By Ian Stobie

Hewlett-Packard, the pioneer and worldwide brand leader in PC laser printers, has updated its main model.

Hewlett-Packard's Laserjet was the most successful of the first wave of low-cost laser printers. Arriving on the scene at the end of 1984, slightly before most of its rivals, it rapidly established itself as the dominant laser for personal computers. HP has since produced several variants of the original Laserjet, but the Laserjet Series II is the first really fundamental redesign. It goes on sale this month at a price of £2,616 for the standard version.

Externally the most noticeable thing about the Laserjet II is that it is physically smaller than its predecessor: it is only slightly bigger than the system box on most AT-level systems. Running costs are also lower. Rather surprisingly, HP has not opted for a higher speed, and like its predecessor the Laserjet II is rated at eight pages a minute.

Like the original HP machine, the Laserjet II is based on a Canon engine, this time the all-new Canon LPB-SX unit. Canon's LPB-II is a complete laser printer based on the same engine. The HP and Canon machines are obviously very similar as far as their basic physical characteristics go, but HP would claim that its machine is the more sophisticated of the two.

At 50lb. the new Laserjet is 20lb. lighter than the original machine, but it is still a hefty object to move around. The 200-sheet paper-input tray projects out of the front. The controls and the slots for the fount cartridges are also on the front. The top of the machine is dominated by a large depression into which the printed paper normally emerges face down and in the right order. Pushing down a flap at the back of the machine reveals a second exit path for the paper, where it emerges face up. This second paper path is flatter, so you use it when you want to print on card or thick envelopes; the Laserjet II can cope with thin card up to 135gsm. in weight.

The top of the machine folds right back to let you get inside to change the toner cartridge or clear a paper jam. Like photocopiers, laser printers do occasionally jam: we experienced this a couple of times when feeding in envelopes, but had no problems with normal paper.

As with the previous Laserjet, the toner cartridge also accommodates the electro-sensitive drum, and you replace both every time you renew the toner. According to HP

the cartridge will last for about 4,000 pages in normal word-processing use — less if you typically produce very dense images, and more if you print a lot of half-empty pages.

The toner/drum cartridge is the only component you have to renew on a regular basis. This means the cost per copy, excluding paper, works out at 2.25 pence. This is less than the previous generation of Canon-based laser printers, but more than some of the other new laser printers such as the Kyocera and Mannesmann-Tally machines, which let you replace toner and drum separately. It is also more than ink-jet or matrix printers.

The Laserjet II's print quality is excellent, even by lasers' high standards. HP says this is

LASERJET II

VERDICT

	POOR	AVERAGE	GOOD	EXCELLENT
Performance	<input type="checkbox"/>	<input type="checkbox"/>	<input checked="" type="checkbox"/>	<input type="checkbox"/>
Ease of use	<input type="checkbox"/>	<input type="checkbox"/>	<input checked="" type="checkbox"/>	<input type="checkbox"/>
Documentation	<input type="checkbox"/>	<input type="checkbox"/>	<input checked="" type="checkbox"/>	<input type="checkbox"/>
Value for money	<input type="checkbox"/>	<input checked="" type="checkbox"/>	<input type="checkbox"/>	<input type="checkbox"/>

A major improvement on the Laserjet, but perhaps not enough to maintain HP's leading position. It is up against some very strong competitors.

because the toner cartridge contains a reformulated and finer toner. It certainly seems to give much blacker and crisper results. Even when examined closely, the horizontal and vertical edges of letters do not break up. The surface of the paper does not feel at all dusty; if anything the letters appear to be raised slightly on the surface. A dial inside the machine lets you adjust the density if you like a lighter effect.

While the Laserjet II is rated at eight pages a minute, offerings from Qume, Kyocera and Mannesmann-Tally claim 10 pages a minute. HP does have a considerably faster laser printer, the Laser 2000, rated at 20 pages a minute, but it is a big machine aimed at the minicomputer and LAN markets. HP presumably feels that eight pages a minute is quite sufficient for a desk-top laser intended for stand-alone PC use.



SPECIFICATION

Resolution: 300 dots per inch horizontally or vertically
Speed: claimed eight pages per minute
Founts: Courier and Courier Bold in 10 pitch, and 16.5 pitch Lineprint founts built-in; extra founts available on cartridge or disc
Memory: 512K standard, expandable in stages to 4.5Mbyte
Noise: claimed 50dB(A)
Paper handling: 200-sheet input, 100-sheet output; manual envelope feed; prints on A4 paper, transparency film and card up to 135gsm.
Interfaces: Centronics parallel and RS-232C serial standard; other options
Consumables: replacement toner/drum cartridge costs £90 and lasts for a claimed 4,000 pages
Dimensions: 482mm.(19in.) x 454mm.(18in.) x 228mm.(8.5in.)
Weight: 22.4kg.(50lb.)
Price: £2,618
Options: 1Mbyte memory board £406, 2Mbyte £821, 4Mbyte £1,650
Manufacturer: made in Japan for Hewlett-Packard Company of Cupertino, California
U.K. supplier: Hewlett-Packard, Enquiry Section, Eskdale Road, Winnersh Triangle, Wokingham, Berkshire RG11 5DZ. Telephone: (0734) 696622.
Available: now



The toner and drum are combined in a single replaceable cartridge.

In practice you will rarely if ever achieve the quoted speed. The best we got was just over seven pages per minute, and our letters benchmark gave the Laserjet II a rating of 5.1 pages per minute. By comparison, the Epson SQ-2500 ink-jet also managed 5.1 pages a minute at our letters benchmark in its draft mode; this fell to 3.5 in quality mode.

Fitting the Laserjet II with extra memory does not directly increase the speed, but it

HP Laserjet Series II

Speed in pages per minute with Practical Computing test data

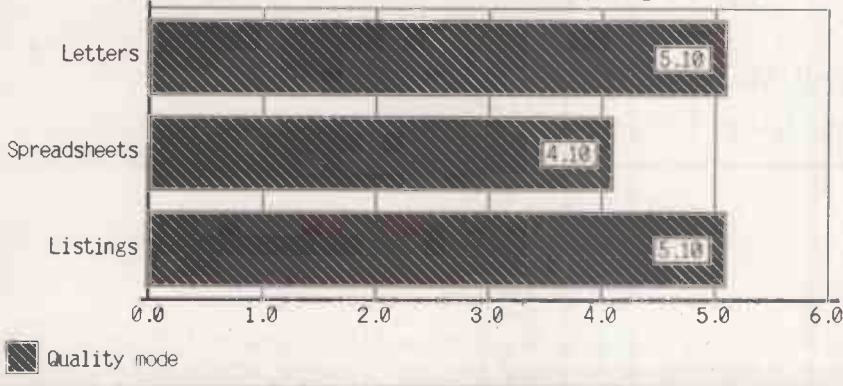

HOW FAST DO THEY GO?

Laser speed is still rated by manufacturers in a somewhat fanciful way. You are only likely to get near the quoted speed when printing very long documents or repeat copies of the same page. The first page of any document always takes a laser a long time. We tried printing a document consisting of just a single letter A, for example; this took the Laserjet II 18 seconds. A first page consisting of a more typical amount of text took us 22 seconds. Pages which involve substantial amounts of graphics can take much longer.

There are several things going on during the delay. The laser printer has to be sent the data to print, and in the case of graphic images this can take some time as a full page of graphics at 300 dots per inch comes to over a megabyte. Text is far quicker to send, but once it arrives at the laser printer it still has to be expanded into a full-resolution bit-map image in the appropriate fount before printing can commence. Repeat copies of a page are always faster because neither of these processes is necessary; the bit map of the page is already there.

Scepticism over the claims of printer manufacturers generally has led us to start timing printers with a set of our own test data. The results for the Laserjet II are interesting, and are summarised on the chart above. As expected the machine does not achieve eight pages a minute: with our tasks it is more like five. Our letters and listing benchmarks are both three pages long, the spreadsheet two. With longer documents you would get a higher average speed. This because most of the delay is before the printing of the first page begins, and it does not go up much as document size increases. This review for example covers 16 pages when printed double-spaced on A4 paper, and took us 2 minutes 11 seconds to print on the Laserjet II. This is an average of 7.3 pages a minute.

does help in practice by increasing the number of pages you can hold in the printer's buffer. However, the major use of the extra memory is to improve the Laserjet II's graphics. On the standard machine you can get about one-third of a page of graphics at full 300dpi resolution, or a whole page at 150dpi. The 1Mbyte memory board lets you do a whole page at 300dpi. There are still larger memory options for specialist users who want to use large numbers of downloaded founts simultaneously or hold several graphics pages buffered in memory.

The Laserjet II is compatible with PCL, HP's own printer command language. The same language is used on the Laserjet and Laserjet Plus. No other emulation is offered at present, but PCL is well established as a standard printer-command language for cheaper laser printers. Most software packages offer Laserjet support on their installation menus.

PCL is not the same thing as DDL, HP's full-blown page-description language, which is not expected until the end of the year. DDL will then be available as an option for the Laserjet II, and probably for the earlier Laserjets as well. HP plans to

release DDL as an add-on board which will probably fit into the PC rather than the laser printer itself.

The Laserjet II has five founts built-in and two slots for optional fount cartridges. You can also download founts directly into printer memory from a PC. The built-in founts are Courier in a 10 character per inch size, and a smaller fount called Lineprint designed for printing things like spreadsheets at 16.5 characters per inch. These two founts are provided in both normal portrait form and landscape form, to allow you to print across the long direction of a sheet of paper. Courier is also provided in bold. HP counts each of these variations as a fount, thus arriving at a figure of five.

With the right software you can blow up one of the Laserjet's built-in founts to provide a headline, for instance, but without a page-description language you lose definition. You really need to hold a bit map of every variation of the fount that you intend to use. The main way to get round the problem of fount variety is to buy extra fount cartridges to fit into the slots at the front of the machine. The Laserjet II takes the same cartridges as the existing HP Laserjet prin-

ters, so a good variety is available. You usually get five founts or fount variations per cartridge; the price varies a great deal but the average cartridge costs about £200.

Like the existing Laserjet Plus, the Laserjet II will allow you to download founts from your PC into your printer for each session. You buy the founts on disc. Typically a disc costs about £175 for 20 founts. These soft founts are less convenient than cartridge founts in that they use up printer memory which would otherwise be available for buffering pages. They also disappear at the end of each session. However, they are cheaper than cartridge-based founts and you can have a large number loaded at a time for more complicated printing applications.

The documentation set looks comprehensive. You get a thick user guide, a clear manual for getting started and also a five-language manual. They are indexed, well illustrated and printed in colour. However, our copies were peppered with typographic errors and minor factual mistakes, which could be confusing.

On paper the Laserjet II does not stack up tremendously well against the competition. The obvious rival in the U.K. is Canon, whose LPB-II is based on the same engine and has a very similar spec. It is the same speed, uses the same toner and has the same consumables costs. It is also around £500 cheaper. Differences come down to the Canon's lack of full PCL support, its smaller maximum optional memory and its name, which in the U.S. at least has less going for it than Hewlett-Packard.

More tangibly, HP offers one-year's on-site warranty in the price, something that is worth having. Laser printers are basically super-intelligent photocopiers, and like photocopiers they can go wrong. Under the guarantee terms HP will turn out to your premises within 24 hours for most places on the U.K. mainland.

But perhaps equally serious competition will come from machines based on different, faster print engines. Examples are the Qume Laser 10, based on the Hitachi engine, and the Manesmann-Tally 910 and Kyocera F-1010, which all cost around £3,000 and are rated at 10 pages a minute. These machines also offer lower consumables cost and better paper handling. We ourselves are particularly impressed with the Manesmann-Tally 910, which seems to emulate virtually everything under the sun to ensure software compatibility.

CONCLUSIONS

■ The Laserjet II is better than any previous model from Hewlett-Packard, but it is still something of a disappointment. The speed has not gone up, and the price has not made any significant move down.

■ Paper handling has improved, and you get more memory as standard. Running costs are also slightly lower. Print quality is excellent.

■ Perhaps the biggest plus is the year's free on-site warranty offered by HP.

■ The HP name may be enough to maintain the company's momentum in the market, but plenty of other lasers are now available — and some of them are better.

Bananas are growing

Available at selected W H Smiths shops and also
available at selected John Lewis Partnership stores

Plus the following specialised computer dealers:-

ENGLAND Marlbro' Computer Services via it's nationwide Enthuset agents throughout the U.K. Tel:(04536)4310 J S Churchill Buckinghamshire Wordmongers Ltd Unit 21 Edison Road Rabans Lane Aylesbury Tel:(0296)437878 Henry Webster
Cambridgeshire Wisbech Computer Services Ltd 11 Hill Street Wisbech Tel:(0945)64146 Ian Duffy **Cornwall** Helston Computer Centre Russel Knights House 18/20 Coinagehall Street Helston Tel:(0326)563765 Mr C Harmer **Cumbria** Cumbria Software Systems Ltd Knorrensyke Walton, Brampton Tel:(06977)3779 **Devon** T A Computer Services 7A High Street Exmouth Tel:(0395)266814 Tony Ayling **Dorset** Tiger Software 66 St. Michael's Lane Bridport Tel:(0308)27691 Terry Gilbert
Durham Desktop 11 West Street Hett Co. Durham Tel:(0388)767244 Duncan Routley **Hampshire** Alton Computers 62 High Street Alton Tel:(0420)87998 Greg Smith • Timatic Systems Ltd Fareham Market Fareham Tel:(0329)239953 Mr. Young
Hertfordshire Melmark Microsystems Warren Place Railway Street Hertford Tel:(0992)554469 N J Tobin **Kent** Canterbury Computer Centre 56-57 Palace Street Canterbury Tel:(0227)462101 David Jones • Computers Plus 65 High Street Sittingbourne Tel:(0795)25677 A Francis • Gravesend Computer Centre 39 The Terrace Gravesend Tel:(0474)323871 Lynne Baxter • Just Disks 18 Crescent Way Green St Green Orpington Tel:(0689)62103 John Taylor • Kent Micro Computers Ltd 55-57 Union Street Maidstone Tel:(0622)52784 Frank Smith • The Village House of Computers 87 Beckenham Lane Shortlands Bromley 01 460 7122 Mr C V Gee **Lancashire** Castle Computers Ltd 5 Frances Passage Lancaster Tel:(0524)61133 Dave Smith • Computer Games Shop 3 Royal Oak Buildings Waterloo Road Blackpool Tel:(0253)48738 • Time Computers Time House 36 Granville Road Blackburn Tel:(0254)63414 Asif Sadiq **London** ElectroSound 123 Perryn Road Acton 01 740 8666 Phil Walsh • Micro Anvika 220A Tottenham Court Road W1 Tel:01 636 2547 A Gohil • Wida Software Ltd 2 Nicholas Gardens W5 Tel:01 567 6941 Tony Williams • Rensoft 215 Ribblesdale Road Streatam SW16 Tel:01 677 0569 Richard Butler **Middlesex** Instant Computer Supplies Ltd 8 High Street Cranford Hounslow Tel:01 897 1534 John Sims **Midlands** Mr Disk 11-12 Three Shires Oak Road Bearwood Warley Tel:021 420 1360 **Norfolk** Computer Plus (Kings Lynn) 40 New Conduit Street King's Lynn Tel:(0553)774550 D J Farrow **Oxford** Oxford Computer Supplies Kings Copse Park Garsington Tel:(0865)716137 **Surrey** Statacom Computers Ltd 20 Grove Road Sutton Tel:01 661 2266 R Suri • Farnham Computers 1 South Street Farnham Tel:(0252)723107 **Sussex** CJE Micros 78 Brighton Road Worthing Tel:(0903)213361 Chris Evans • Independent Software Pepabera Findon Road Findon (0273)453568 Peter Worley **Yorkshire** Ashdown Computers The Studio Byram Arcade Westgate Huddersfield Tel:(0484)510776 • P C Electronics (Yorkshire) Ltd 131 Pasture Road Goole North Humberside Tel:(0405)768320 P Cliff • Wise Owl Software Ltd Unit 37 Brampton Centre Brampton Road Wath-Upon-Deerne Tel:(0709)872703 Bob Lees
NORTHERN IRELAND TC Computing Services 28 Kenvarra Park Coleraine Co Londonderry Tel:(0265)53155 John Trott
SCOTLAND Almac Grangemouth Stirlingshire Tel:(0324)482435 • Vics 31/33 South Street Perth Tel:(0738)36704
David Vicary
WALES Posi-Tron Computing 15 Central Precinct Llanelli Dyfed Tel:(0554)759624

If, as an end user you have trouble getting bananas locally, tell your nearest computer shop to ring us, and we'll send them banana dealer details.

*If you are a computer shop, and you are interested in a banana dealership, call our dealer hot line on:-
Tel: (042 873) 4934 [24hr] or fax us on: (042 873) 6676 or Telex us on 858623 Telbur G*

Customer testimonials

"I've bought many other disks, but find bananas by far the most reliable" - J A Ducat, Bath
"I'm delighted with bananas, I recommended them to all my fellow teachers" - David Marett, Jersey
"Customer service at it's best" - T Martin, Preston

DISKING International, 1 Royal Parade, Hindhead, Surrey. GU26 6TD. U.K.
Put Quality of service & product first, & let price take care of itself.

Bananas keep trucking

and the truck's for FREE



Bananas are growing

Last year saw the launch of our highly successful Banana reversible disks. Apart from the IBM PC-AT, these D/Sided disks suit ALL 5" drives. We know, because we have them ALL certified for both 48tpi & 96 tpi. What is more they have 2 w/p notches & index holes, so they are truly reversible if required.

"What about microdisks"

you kept asking. Well here they are. The family is complete. The plantation's in full swing.

FREE

We give a banana pen with every ten disks or microdisks, and should you buy 40 disks (4 ten-packs or 2 crates) OR 20 microdisks, you will receive a Mercedes banana truck.

Official orders from plcs & Government bodies are welcome.

DISKING

FREEPOST Hindhead Surrey GU26 6BR
Tel (042 873) 4834 • Fax (042 873) 6676
Twx 858623 Telbur G

To: DISKING, FREEPOST, Hindhead, Surrey, GU26 6BR
Telephone: (042 873) 4834 • Fax: (042 873) 6676 • Telex 858623 Telbur G

ORDER FORM	PRICE	QUANTITY
	exc VAT	
BANANA Ten disks D/Sided 48/96 tpi Reversible disks	8.65	_____
BANANA-C Crates (twenty disks as above)	17.30	_____
BM1D Ten-packs S/Sided 135 tpi Microdisks	19.95	_____
BM2D Ten-packs D/Sided 135 tpi Microdisks	26.04	_____
SLIM 5B Banana Library box for ten disks	1.50	_____
SLIM 3B Banana Library box for ten microdisks (not shown)	1.00	_____
Mercedes Truck FREE with every 40 disks or 20 microdisks		_____
Goods Total exc VAT		_____
U.K. Delivery (see below) exc VAT		_____
Sub Total exc VAT		_____
V A T @ 15%		_____
Value of cheque payable to Disking		_____

OR Please debit my ACCESS/VISA No: _____

Name/Company: _____

Address: _____

Tel. No: _____

U.K. P&P exc VAT (disks/microdisks)

10 - 20 disks 95p per ten • 30 - 50 disks 75p per ten • 60 - 90 disks 60p per ten
100+ disks POST FREE

XPRESS COLOUR DTP

By Carol Hammond

With colour soon to be available on the Macintosh family a full-feature desk-top publishing program has been launched which takes advantage of it.

At £695 Xpress is the most expensive desk-top publishing (DTP) package for the Macintosh we have reviewed. It is also the most sophisticated. It is clearly not for someone who just wants to produce the odd newsletter. Rather it is aimed at the serious Pagemaker user — someone who regularly puts together professional-looking manuals or presentations, or maybe even small journals or newspapers. In the IBM world they would be looking at a package like Ventura Publisher.

Xpress comes on three discs: a Startup disc, a Program disc and a Data disc. You use the Data disc to install the program on a hard disc. When you click on the Xpress icon on the Macintosh desk top you are met by the Xpress menu bar. It lists nine options: File, Edit, Font, Style, Paragraph, Item, Page, View and Utilities.

Opening the File menu and choosing the New command will bring up a dialogue box showing the default settings for a page. You can alter the page size, including its width and height, and the top, bottom, left and right margins. You also specify whether your document is to be double-sided, and set the page guidelines saying how many columns of text there are to be to a page and what the space between columns — the gutter width — should be.

Clicking on OK in the dialogue box brings you to your new document. The menu bar sits along the top of the screen, with scroll bars situated to the right and at the bottom. To the left there is a tool palette. Below the menu bar and to the right of the palette is a ruler. The program accepts measurements in inches, picas, picas/inches centimetres and points. The same units are used horizontally and vertically, except when using picas/inches: in this case picas are used on the horizontal ruler and inches on the vertical, as is traditional in newspaper printing. Within the window that takes up the remainder of the screen there are guidelines to show you where the edges of the page lie.

You can view a page actual size, or choose one of the commands from the View menu

to view it at 50 percent, 75 percent or 200 percent of actual size. You can also reduce the page to fit in the window. The Facing Pages option displays a complete double-page spread, so that you can work on its layout as a unit. Heyden and Son, the distributor of Xpress, claims that you can have four pages on-screen at once if you have one of the large Mac screens like the Megascreeen.

The palette works much like those in MacDraw or Macpaint. You select one of the 12 tools by clicking on the appropriate icon. Four tools create boxes, two draw lines, two draw arrows and two link boxes. There is also a pointer to move boxes, and an editing tool. Line thicknesses can range from hair-line up to 8pt thick: you set the thickness on the Item menu.

Xpress uses the concept of boxes for positioning text and illustrations on the page — you can have text boxes and picture boxes. Boxes can be resized, moved, linked, laid on top of one another and nested within one another. A box that contains another is known as a parent box, while the box or lines inside it are called children.

To create a box you select the text box tool or one of the three picture box tools. Short dotted lines appear in the rulers to identify the four corners of a box. You make a box inactive by clicking outside it, and make it active again by clicking inside it. Small bars or handles appear round the edge of the box when it is active.

DELETION

If you start drawing a box in the wrong place you cannot just drag the mouse back to make it disappear; you have to go back to the Item menu and select Delete. This usually eliminates the active box plus its contents. However, if the box is one of a chain of linked boxes containing a long section of continuous text, the linked text from the deleted box flows on into other linked boxes.

I found this deletion procedure awkward, and sometimes had to lose valuable work when I wanted to delete a box. Delete does not work like Undo, just deleting the last item; instead it deletes the current active box. It took me a while to realise this, and sometimes the active box turned out not to be the one I thought it was because my pointer was in the wrong place. To be fair, the program does give you several warnings that you may delete items other than the box itself. No doubt, as you become familiar with the package you are less likely to draw boxes, say, outside another box when you



SPECIFICATION

Description: WYSIWYG page make-up program with built-in word processor and colour capability

Hardware required: 512K enhanced Mac with 800K disc drive, Mac Plus, Mac SE or Mac II; requires an external disc drive or hard disc, 1Mbyte of memory recommended; Postscript-compatible printer or typesetting equipment

Copy protection: three backup copies allowed

Price: £695

Publisher: Quark Inc. of Denver, Colorado

U.K. supplier: Heyden and Son, Spectrum House, Hillview Gardens, London NW4 2JQ. Telephone: 01-203 5171

Available: now

wanted to draw inside it, but the procedure still seems unsatisfactory.

Resizing also proved to be a fag. You select the cross-shaped mover tool, click on the box you want to resize to make it active and move the pointer to one of the handles. When it is correctly positioned the pointer changes into a little hand. You can then drag the hand pointer until the box is adjusted to the size you want. Getting the little hand to appear proved to be quite a feat in itself, especially with small boxes.

A package costing as much as Xpress should really have alternative ways of sizing boxes — by entering measurements, for example. The only help available is the Snap to Guides command from the View menu. When this command is selected, items you are dragging around snap to the guidelines when they are near enough. This way you can align boxes and lines precisely. But if you are going to do a complicated layout you need to be able to position things equally precisely at any position on the page.

The Modify command from the Item menu overcomes this problem to a large extent, but it took me quite a few sessions with Xpress before I realised what it was. One of the drawbacks of Xpress is that it has so many features that it takes a while to discover them all, remember how to get at them and work out exactly what you can do with them.

XPRESS ON THE MACII

You can resize picture boxes by altering their width or height.

You can specify what shade an assigned colour is to be.

The size and proportions of a picture can be adjusted.

Wraparound is easy to implement in Xpress.

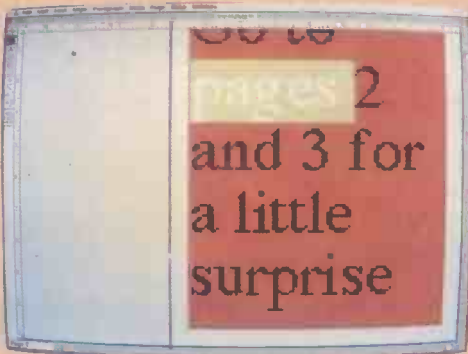
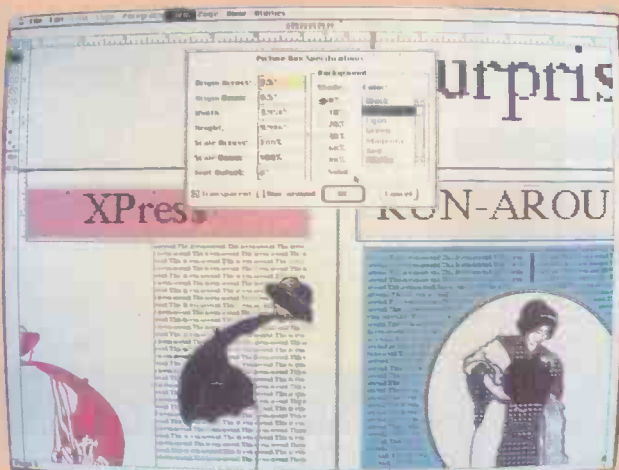
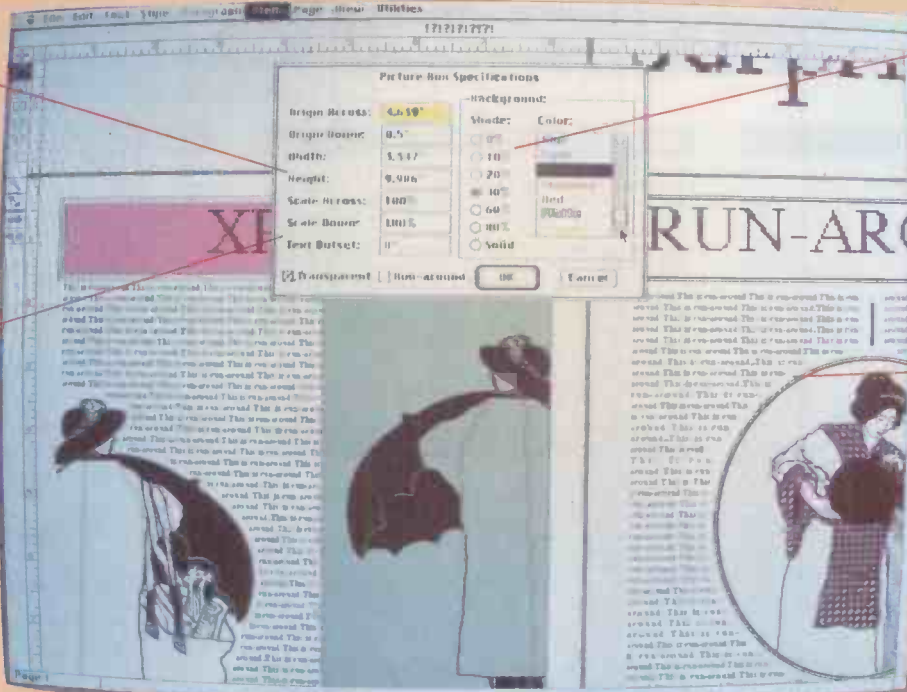

Above left: You can assign colour to pictures, headlines, frames, text and backgrounds. Above right: When you choose a frame you are shown what it will look like in a particular colour and shade. Left: Highlighting colours automatically contrast with the matter selected. Right: Graphics imported from other programs can appear in colour.

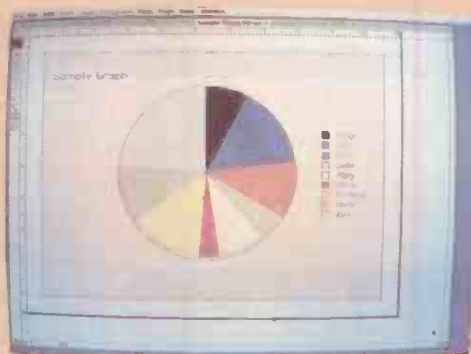

Modify is available when a box or line is active. A dialogue box appears, giving the width and height of a box and its position relative to the zero points on the rulers. You can alter these measurements to make fine adjustments if you want. You can also alter the number of columns and the gutter width.

Once you have entered text into a box you can manipulate and edit it to produce a number of highly sophisticated effects which proved to be simple to achieve. Xpress has an integrated word processor with a built-in 80,000-word dictionary and spelling checker. Its other facilities include cut and paste, word count, and search and

replace with wild-card options. When entering text you can show non-printing features like spaces and end of paragraphs using Show Invisibles from the View menu.

The Preferences option from the Edit menu gives you control over some of the more detailed aspects of the package, including what unit of measurement to work

(continued on page 57)

(continued from page 55)

in, Auto-Hyphenation, the justification expansion method, Auto-Kerning, Auto-Page Insertion, and character width.

Auto-Hyphenation breaks words according to the Xpress dictionary and hyphenation algorithm. You can determine the smallest word to be hyphenated, the smallest number of letters to precede a hyphen and whether to break capitalised words. The justification expansion method allows you to select whether you want more space between words than characters, space added only between words or space distributed as evenly as possible throughout.

Auto-Kerning spaces letter pairs according to the kerning tables that go with individual founts. Character Width determines whether characters should be displayed in their exact widths or not. Auto-Pages takes care of placing any extra pages that may have to be created to take overflow text at the end of a story, document or section.

You edit in the usual Macwrite fashion using the mouse and pull-down menus, or by using keyboard commands if you wish. The menus list keyboard commands you can use instead of the mouse. You can also specify whether you want single or double line spacing, a blank line before the first line of text in a paragraph, indents and hanging indents.

It is here that you can change the leading of text. Xpress defaults to auto leading — which is the same as single space. You can alter the leading to a particular number of points, regardless of point size, or you can add and subtract leading point by point to move lines further apart or closer together.

The Fount menu lists the founts available and the Postscript Escape command. If you want to send instructions in Postscript to an output device you select Postscript Escape and your instructions will not print or show on-screen.

Fount sizes can be from two points to 500 points. They are selected from the Style menu, where you also choose the style of the type. Here you can also choose to compress or expand text horizontally by a factor which can be varied from 25 percent to 200 percent. You can also kern individual pairs of letters manually.

LINKED TEXT

Text boxes that are linked so that text flows from one to the next can be formatted to contain continuation lines. You link boxes by choosing the linking tool from the palette and clicking inside the boxes you want to link. In the same way you can link default pages that have been set up with templates for headers, footers, page numbers, boxes and pictures. Once you have created a default text chain the text will always flow in the way you specify throughout those pages.

You can surround any box with a border by choosing Frame from the Item menu. A dialogue box appears which allows you to choose from various styles of frame, what colour it should be and what thickness. You can design your own frames too, using the

Frame Editor program within the Xpress folder. You could, for example, incorporate your company logo or other symbol as part of a border.

To insert a picture or graphic into an Xpress document you create a box using one of the picture box tools and then paste in a picture from your Scrapbook file or by choosing Get Picture from the File menu. Get Picture will show the directory of the current folder or disc. You can import bit-map files from paint programs like Macpaint and Full Paint, Pict-format files from draw programs like Macdraw and Cricket Graph, and pictures in Encapsulated Postscript format such as those prepared by Adobe Illustrator.

You can alter the size of a picture by choosing Modify from the Item menu. This option allows you to alter the size of the box and adjust the size and proportions of a picture anywhere in the range between 10 percent to 1,000 percent of its original size. If you wish, Xpress will run text round a box or a picture. It is the best attempt at wrap-around on a Macintosh DTP package we

XPRESS				
PC VERDICT				
	POOR	AVERAGE	GOOD	EXCELLENT
Performance	<input type="checkbox"/>	<input type="checkbox"/>	<input type="checkbox"/>	<input checked="" type="checkbox"/>
Ease of use	<input type="checkbox"/>	<input type="checkbox"/>	<input checked="" type="checkbox"/>	<input type="checkbox"/>
Documentation	<input type="checkbox"/>	<input type="checkbox"/>	<input checked="" type="checkbox"/>	<input type="checkbox"/>
Value for money	<input type="checkbox"/>	<input type="checkbox"/>	<input checked="" type="checkbox"/>	<input type="checkbox"/>

For serious DTP users who need a full range of DTP facilities and colour.

have seen since we reviewed Just Text in November 1986, and it is much easier to use.

You also use the Modify command to introduce colour into a document. After selecting the picture box or text box to which you want to assign the background colour you choose which of eight colours you want, and at what shade. You select colours for a line, arrow or frame in the same way.

To assign colour to text you select the required section and choose Other from the Style menu. You use this technique to print white letters on a black background for a reversed-out effect. Pictures that include colour information imported from other programs, such as Cricket Draw, will print in colour.

Obviously you cannot see colour on a monochrome machine: you check the colour of an item by selecting it and going to the relevant menu. Shading is also not visible on-screen, and does not show up on Imagewriter printers; it is really intended for use on high-resolution devices like a Laserwriter or Linotronic.

We were able to see Xpress running on a Mac II. The apple to signify the Apple menu appears in the colours of the Apple livery. Highlighting on dialogue boxes appears in

yellow. The colour options appear in the appropriate colour. When you choose a frame the one selected appears at the top of the dialogue box and will change colour and shade as specified. Colour graphics imported from packages like Cricket Graph are displayed in colour. Highlighting is automatically set to contrast with the colour of the matter being selected.

Text that contains spot colour can be printed in two ways. If you have an Imagewriter II fitted with a colour ribbon you should be able to use it to print out your document in full colour simply by switching on Colour Printing in the Page Setup dialogue box. The results you get are pretty crude, but good enough to preview the appearance of your document when it is finally printed in colour. Alternatively you can choose Make Separations from the Print dialogue box, and Xpress will then produce a separate sheet for each colour on each page. So if your headline is in green, the text in black and the frame round a picture in red, you will get three sheets of paper: one will print the frame, another the text and the third the headline.

You can also select Registration Marks from the Print dialogue box. They are useful if you have a printer, such as the Linotronic, that can handle paper large enough to accommodate registration marks outside the normal page margins. The registration marks are lines which print in the same position on each sheet and can be used to line up colour separations.

The manual is large and copiously illustrated. It is divided into four main sections covering the basic features, menus and commands, the frame editor, and hints for type-setting. There are also appendices detailing keyboard command options, and a glossary. The examples used for the tutorial sessions are rather disappointing, given the power of the program, and do not show it off to its best effect. I also felt the manual could have been slightly more methodical when explaining how to use the program, though dealing adequately with such a large program is bound to be difficult.

CONCLUSIONS

■ Xpress brings colour desk-top publishing to the Mac. At the moment this is primarily useful for those who want to produce colour separations, but when the Mac II becomes available users will be able to get the full benefit of a colour DTP package.

■ Xpress is expensive, but the cost is likely to be justifiable for those who want powerful DTP features like tracking, kerning and wrap-around, not to mention colour.

■ Because Xpress is a sophisticated package with a great many features it takes a long time to learn how to use fully. It is probably too complicated for occasional users, and a graphic designer is likely to be needed to use its facilities to full effect.

■ For those who just want to print a simple newsletter there are cheaper packages around which could do the job as easily. Features like word count, mixed-dimension measurements, kerning and spot colour may make it of particular interest to those producing small journals and newspapers.

PRIME TIME PERSONAL ORGANISER

By Carol Hammond

If your working life is not already encapsulated within a leather-bound Filofax this computerised version may help you co-ordinate your diary.

As the fad for nifty personal organisers has taken hold so it has encroached into the world of micros. Borland produced the Sidekick pop-up, which combines a notebook, calendar, diary and telephone directory. It was followed by Travelling Sidekick, allowing you to carry your printout in a Filofax-style binder. More recently Showering Business Systems released Portex, complete with an Italian leather binder and custom-designed paper. For the less fashion-conscious who are still interested in having a sophisticated diary on their micro to organise their time, Prime Time is one alternative.

Prime Time rather grandiosely calls itself a "personal time-management system". It combines the features of a diary, an address book, a notebook and an autodialler. Into the diary you enter appointments and things to do. You can rank tasks by class, priority or when they are due, and keep a record of tasks assigned to other people. You can build up a database of names together with addresses and telephone numbers, which you can then use to ring people with the autodialling facility. You can tag important dates and appointments with alarms and notes. You can also print out reports detailing appointments, tasks, phone lists, assignments and your daily agenda.

At £99 Prime Time is slightly more expensive than its rivals. It also requires 118K of RAM, which is more even than Lotus's power pop-up, Metro, which we reviewed last month. Prime Time does not have Metro's powerful word processor, and notes can only be up to 350 characters long, but its alarm facility and the ability to generate appointments lists, assign tasks and print out reports may win it favour.

The Prime Time program comes on a single unprotected disc along with a utility/tutorial disc. One of the utilities can be used to compress your appointments or tasks databases to create more space on your disc. There is also a facility for restoring your database should your disc become corrupted.

We had problems installing Prime Time. We religiously followed the instructions in

the documentation, but they did not work. Eventually we had to copy the program manually to our hard disc.

When you run Prime Time you are met by the Date/Time screen. The Prime Time screen display is divided into two main parts: the control panel and the data area. Underneath them, at the bottom of the screen, is the message line, which is used to display reminders, error and warning messages, plus what the current functions of the 10 function keys are. Context-sensitive help is available via the f1 key.

The control panel is further divided into three areas: a line containing the current date and time, the function selection menu, and the reference calendar. The reference calendar shows the current date in brackets and the pointer date in reverse video. You use the pointer to highlight a particular date.

PRIME TIME				
VERDICT				
	POOR	AVERAGE	GOOD	EXCELLENT
Performance	<input type="checkbox"/>	<input type="checkbox"/>	<input checked="" type="checkbox"/>	<input type="checkbox"/>
Ease of use	<input type="checkbox"/>	<input type="checkbox"/>	<input type="checkbox"/>	<input checked="" type="checkbox"/>
Documentation	<input type="checkbox"/>	<input type="checkbox"/>	<input checked="" type="checkbox"/>	<input type="checkbox"/>
Value for money	<input type="checkbox"/>	<input checked="" type="checkbox"/>	<input type="checkbox"/>	<input type="checkbox"/>
<input type="checkbox"/> A well-designed package to help you organise your time.				

To highlight a function you press the space bar or the cursor keys; you then press Enter to select it. You can also press the relevant key corresponding to the function desired: C for Assignments, for example. Some of the functions have more than one selection associated with them; it appears on the preview line below the list of functions, and to select it you just press Enter or the first letter of what you want to choose: say, U for Update. To leave any screen you just press Esc or X.

Moving around Prime Time is simple, and it did not take long to master how to get where. This is essential in a program which you want to refer to occasionally but quickly, without having to remember complicated key combinations. There is a speedkey capability too, which allows you to move from one function to another by pressing Alt and the relevant letter of the function you want



SPECIFICATION

Description: personal time-management system

Hardware required: IBM PC, PC/AT or compatible with MS-DOS 2 and disc drive; occupies 118K RAM

Copy protection: none

Price: £99

Publisher: Wiseware Inc. of Costa Mesa, California

U.K. supplier: Wilder Systems, MVA House, Victoria Way, Woking, Surrey GU21 1DD. Telephone: (04862) 21552

Available: now

to move to. This is easy to remember, as the function-key menu remains at the top of the screen all the time.

When you first use Prime Time you enter information in the User Profile screen. Here you customise the system to suit your requirements. For example, you say whether you want a colour screen, whether you want the alarm on and for how long, when you want your schedule time to start and end, how your daily schedule should be incremented, and what your horizon days are. Your horizon date is the last date for which appointments, notes or tasks can be generated; it is calculated by adding a number of days you specify to the current date.

You choose if you want Prime Time to be memory resident by entering Y against Resident Status in the User Profile screen. Initially the hot keys are set to Ctrl-Alt, though you can change this combination if you wish.

The reference calendar displays one month at a time. You can move backwards and forwards through the calendar a day, a week, a month or a year at a time using the cursor keys, control keys, and Page Up and Page Down. End brings you to the last day of the month, and Home returns you to the current date. The same keys are used to highlight entries on the Review screens,

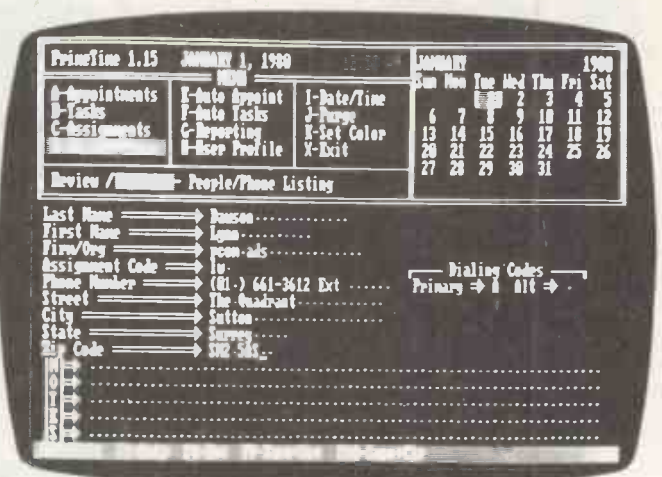
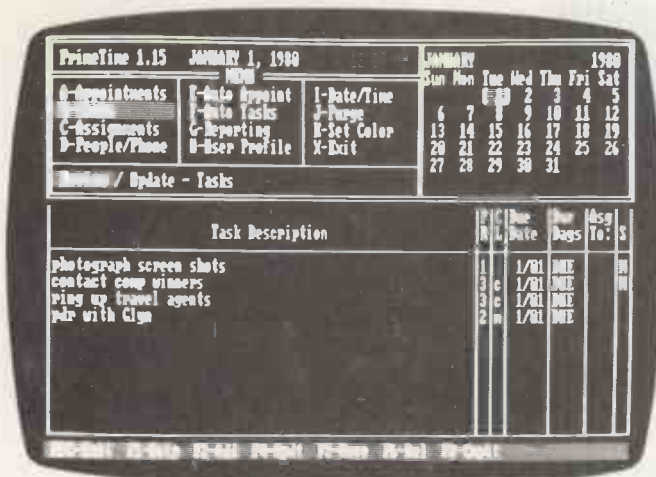

where you see what tasks or appointments you have, and to point to entries on the Update screens where you enter new appointments and tasks.

You differentiate between whether you want key depressions to apply to the calendar or the display area by toggling the Num Lock key. In Calendar mode the word Cal will appear on the calendar; otherwise you are in Edit mode. This doubling up of functions is not at all confusing; rather it helps the program seem consistent and natural to use.

The main application for Prime Time is keeping track of appointments and tasks. To enter appointments you select the Appointments option, followed by Review if you want to see what appointments you have for the date selected or Update if you want to enter or alter an appointment. A five-column Appointments screen then appears in the display area.

The first column, headed A for alarm, will contain an asterisk when you have set an alarm for an appointment shown on that line. The alarm will sound even if you are using another program. The Time column contains the time of day, or the word "Note" where that line contains a note entry. The third column contains a description of the appointment. Where an appointment extends into the next time block on the schedule there is an arrow to show how long it lasts. If appointments overlap, Prime Time beeps as a warning and you have to tell it to overlap appointments by indenting one after another.

AUTOMATIC APPOINTMENT

The fourth column, labelled Until, shows when an appointment ends. The final column, labelled S for status, will contain an N if there are any notes associated with the appointment or note, or a G if the appointment or note was generated automatically.

You can add an appointment by going directly to the Appointments Update screen from the main menu, or by pressing f2 for Add or f4 for Update from within the Review screen. Here you enter the Appoint/Note Date, a description, the start and end time of an appointment, whether you want an alarm, whether an appointment or note should be repeated over a number of

consecutive days, plus any notes you want to associate with the appointment. Right: You can develop your own database of names and addresses using the People/Phone function.

The Task function works in a similar fashion. The Task Review screen has seven columns called Task Description, Pr, Cl, Due Date, Due Days, Asg To and S. The Pr column contains the priority assigned to a task. Cl specifies what classification it is — say, C for phone call. Due Date gives a date by which the task should be done, and Due Days tells you how many days there are to go until the due date. Asg will give the character code of whoever you have assigned a task to. The Task Update screen follows a similar pattern to that for Appointments.

DATE GENERATOR

Both tasks and appointments can be generated automatically by choosing the Auto Tasks or Auto Appoint options. You use the Automatic Date Generator where you can specify that a task should be generated every Monday, say, or the third Thursday of every month or every two weeks after 18 July.

You assign tasks to other people using the Assignments option. The Assignments Review screen looks exactly like the Tasks Review screen except that the column Asg To appears first rather than sixth. You enter the code of the person you want to assign a task to in this column. The code is determined by what you have entered in your People/Phone database.

The People/Phone Review screen contains five columns: Name, Code, Firm/Organisation, Phone Number, and Ext for extension. To search for a person's name you just press the first four letters of their name. In the Update screen you enter the person's name, address and telephone number, the name of their company and an assignment code. If you have a Hayes-compatible modem you can dial someone on your phone list by highlighting their name and pressing f3.

The Reporting option allows you to display a report on-screen, write it to a file for

printing later, or produce immediate print-outs of information. You can have reports detailing your daily agenda, future appointments and notes, future tasks, completed tasks, phone list, assignment status, future assignments and completed assignments.

Dates can be entered in a number of ways: just entering 3 or 3/10 for example will give the complete date as Prime Time supplies the missing elements from the pointer date. You can also enter dates by specifying increments: entering 2d on 24 December will give 26 December, as will entering -1m on 26 January. Where the month of February occurs, or you go from a 31-day month to a 30-day month, Prime Time will go to the nearest possible day in the month. Times can be entered in a similar abbreviated fashion.

In the version we used dates had to be entered in American format. This proved fiddly and could be disastrous. It would be all too easy to enter 5/4 rather than 4/5 for 5 April and to miss an important appointment as a result. Prime Time's American roots were also apparent in the manual, which under Dates to Remember gave only the Queen's Birthday as a British date, others being U.S. Independence Day, Washington's birthday and suchlike. A spokesman for Wilder Systems, Prime Time's U.K. distributor, said the program had been altered to accept English date formats.

Otherwise the manual is clear, with diagrams and fairly detailed explanations. The section to accompany the tutorial can become tiresome as it takes you through a week in the life of Timely Tim to accustom you to the program. I found myself concentrating more on remembering his friends' names than on learning how to use the program.

CONCLUSIONS

■ Prime Time is easy to learn and use — an essential attribute for an on-screen diary, address book and notebook which you want to be able to access and use quickly.

■ It has a few added extras, like the ability to print out reports and give alarm signals. They make it worth a look if you think you will use them.

■ The version we had was let down by the U.S. date format it requires. Make sure you get an anglicised version.

NEW

80386



£4650

Including EGA Monitor

- * 80386 at 16Mhz
- * 1Mb Ram Expandable 2Mb on board
- * 40Mb Hard Disk Drive
- * 1.2 Floppy Disk Drive
- * Maths Co-processor Socket
- * 8 Slots
- * EGA Display Card
- * 14" EGA Monitor
- * Parallel Printer Port
- * RS232 Communications Port
- * Calendar Clock
- * 200 Watt Power Supply
- * Enhanced Keyboard with 101 keys
- * MS-Dos 3.x

PC, XT, & AT.

AT—6,8,10Mhz

£1429

2 x 1.2Mb Drives

£1675

20Mb & 1 x 1.2Mb Drives

PC & XT—4.77 & 8Mhz

£625

2 x 360Kb Drives

£995

20Mb & 1 x 360Kb Drives



- * PC & XT 8088-2 at 4.77 or 8Mhz
- * AT 80286 at 6,8 or 10Mhz
- * 640Kb Ram (Expandable to 1Mb on AT)
- * Maths Co-Processor Socket
- * 8 Slots
- * Hercules compatible Monographic Display Card
- * Parallel Printer Port
- * RS232 Communications Port
- * Calendar Clock
- * 150 watt Power Supply PC & XT
- * 180 watt Power Supply AT
- * 14" Tilt & Swivel Monochrome Monitor
- * Turbo Switch, Activity LED's & Reset on Front Panel
- * MS-Dos 3.x

OURS 88

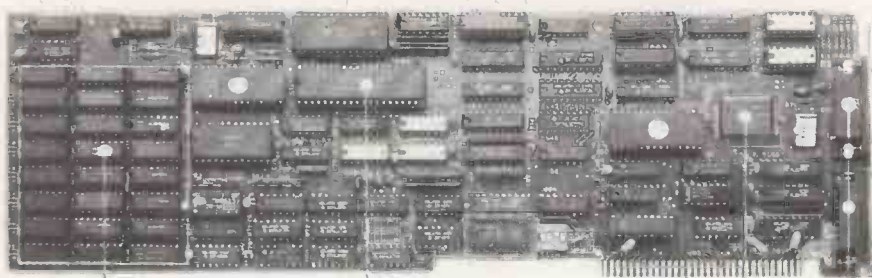

RAM: 256K expandable To 704K

CPU: CMOS 8088 with 6.67MHz

VLSI: Color IC

15 PIN D-Type Connection

£616

Complete with Dual Frequency 14" Monitor, Cables & Keyboard.

- * NEC V20 at 6.67 Mhz
- * 256Kb Ram expandable to 740Kb
- * Parallel Printer Port
- * RS232 Communications Port
- * Disk and Peripheral Sharing
- * File Lock Protection
- * Cabling to Maximum Length of 200ft.
- * NORTON SI 2.4
- * Requires MS—Dos 3.x

The OURS88 Expansion Card is a breakthrough in PC/AT Technology, offering significant saving when compared with additional PC's or Networked Work Stations. Utilising a Single Slot to perform the Network function of a full Computer it provides convenient operation of both data and any combination of peripherals.

Barbatan Limited

35-38 High Street, Bristol. BS1 2AW
Telephone: Bristol, (0272) 213928
Fax (0272) 213541

→ circle 115 on enquiry card ←

All prices quoted exclude VAT

DEALER ENQUIRIES INVITED

SETTING THE STANDARD

TRISOFT LTD 0629-733111

PROFESSIONAL ADVICE ▶ LOW PRICES ▶ HOT LINE SUPPORT ▶ FAST SERVICE

Whether you are seeking specialist advice or simply wish to buy at a competitive price, we believe that Trisoft Ltd. offers a service second to none. Apart from offering around 300 software packages and a large range of add-on boards, we are also authorised dealers for APRICOT, OLIVETTI, TANDON and NORTHSTAR.

▶ SOFTWARE

DBASE III PLUS.....	£335
LOTUS 1 - 2 - 3	£239
FRAMEWORK 2	£320
SUPERCALC 4	£195
WORDSTAR 2000	£245
DATAEASE	£385
REFLEX	£79
MULTIMATE	£199
MS WORD 3	£260
WORDCRAFT	£320
WORD PERFECT 4.2	£260
WORDSTAR PROF	£215
MULTIPLAN 2	£145
VP PLANNER	£75
JAVELIN	£380
SMART 3	£395
SYMPHONY	£339
DOMINO	£375
LATTICE C	£275
MS C COMPILER	£265
PEGASUS	P.O.A.
MULTISOFT	P.O.A.

▶ BOARDS

INTEL ABOVE BOARD FROM	£295
RAMPAGE	P.O.A.
AST SIX PAK PLUS 384K	£245
AST 5251 MOD.11	£599
HERCULES MONO PLUS	£189
HERCULES COLOUR	£115
PARADISE AUTO EGA	£295
ORCHID TINY TURBO 286	£395
INTER QUADRAM EGA + (SHORT)	£275

▶ PLOTTERS/LASER PRINTERS ETC.

ROLAND DXY-880A A3 PLOTTER	£675
ROLAND DXY-980A A3 PLOTTER	£945
ROLAND DPX 2000 A2 PLOTTER	£3245
HP LASER JET	£2185
HP LASER JET PLUS	£2885
CALCOMP 1043 A0 PLOTTER	£7643
CANON LBP A1 LASER	£1985
CANON LBP A2 LASER	£2985
TONER CARTRIDGE FOR A1/A2	£85
8087/80287	P.O.A.
MS MOUSE	£145
PC MOUSE	£145
SUMMA MOUSE	£89

▶ COMPUTER SYSTEMS

ALL SYSTEMS INCLUDE MONO SCREEN, KEYBOARD AND MSDOS

OLIVETTI M24 SP, 10 MHZ PROCESSOR, 20 MB HARD DISK, 640K RAM	£1995
OLIVETTI M28, 20 MB HARD DISK, 512K RAM	£2295
OLIVETTI M28, AS ABOVE BUT 40 MB HARD DISK	£2995
FOR COLOUR MONITOR ADD	£235
APRICOT XEN-i HD, 20 MB HARD DISK, 1 MB RAM, PAPER WHITE MONITOR	£2495
APRICOT XEN-Xi10, 10 MB HARD DISK, 512K RAM, PAPER WHITE MONITOR	£1695
APRICOT XEN -Xi20, AS ABOVE BUT 20 MB HARD DISK	£2045

▶▶ FULL TANDON RANGE ◀◀
▶▶ NOW AVAILABLE ◀◀

ACCOUNTING SOLUTIONS FROM TRISOFT

TRISOFT LTD. are authorised dealers for SAGE, PEGASUS, MULTISOFT, TETRA and MULTIPAC accounting software.

PEGASUS, MULTI-USER and XENIX systems.

MULTISOFT & TETRA, XENIX systems.

Unrivalled accounting expertise in London and the Midlands.

We supply software only or full systems.

Full range of training and maintenance support services from our qualified accountants.



▶ EXAMPLE SYSTEMS

TANDON PCX 10, 10 MB HARD DISK, 1x360K FLOPPY, 256K RAM KEYBOARD, MONO MONITOR,MS-DOS, ANY 4 PEGASUS MODULES	£1595
OLIVETTI M28, 2 MB RAM, 4-WAY SERIAL CARD, LEVEL V XENIX, KEYBOARD, MONO MONITOR, 3 x WY-50 WYSE TERMINALS, 4 x MULTISOFT XENIX MODULES	£8995.00

▶ ENTRY LEVEL CAD SYSTEM

OLIVETTI M24, 20 MB HARD DISK, 1 x 360K FLOPPY, 640K RAM, 7 EXPANSION SLOTS, MONO MONITOR, KEYBOARD, MS-DOS, ROLAND DXY-880A A3 PLOTTER, CALCOMP 2200 DIGITIZER, AUTOCAD, AUTOCAD ADEX 1 + 2, 8087 8 MHZ CO-PROCESSOR ..	£5495.00
--	----------

▶ PROFESSIONAL CAD SYSTEM

TANDON PCA 20, 80286 PROCESSOR(8 MHZ), 640K RAM, 20 MB HARD DISK, MONO MONITOR, KEYBOARD, MS-DOS, CAMBRIDGE 1024 20" MONO SCREEN (1024 x 768 RESOLUTION), AUTOCAD WITH ADEXS 1,2 AND 3 (VERS. 2.5), 80287 CO-PROCESSOR, CALCOMP 25120 DIGITISER, CALCOMP A0 1043 PLOTTER, FREE ON-SITE INSTALLATION IN MOST PARTS OF THE U.K. 3 MONTHS ON-SITE WARRANTY ..	£13950.00
--	-----------

▶ COMMUNICATIONS

We supply the complete range of HAYES and DOWTY (HAYES-Compatible) MODEMS and SUPPORTING SOFTWARE for most communications requirements. Please call for details.

▶ EDUCATION

Users in Education please call for details of special prices available on certain products.

Attractive LEASE and LEASE PURCHASE Facilities Available.



▶ All prices are subject to carriage and V.A.T. ▶ All software prices are for IBM and compatibles. For other formats, please enquire.

TRISOFT LTD

DARLEY DALE, MATLOCK, DERBYSHIRE DE4 3BP

TELEPHONE (0629) 733111, TELEX 8950511 ONEONE G (please quote ref - TRISOFT.)

▶ ELECTRONIC MAIL - TELECOM GOLD 83: NTG344 ONE TO ONE 12977001 PRESTEL 533544601...▶

→ circle 116 on enquiry card ←

IF YOU KNEW
THE TRUTH ABOUT
THIS PRINTER,
YOU'D GET
AN AWFUL SHOCK.

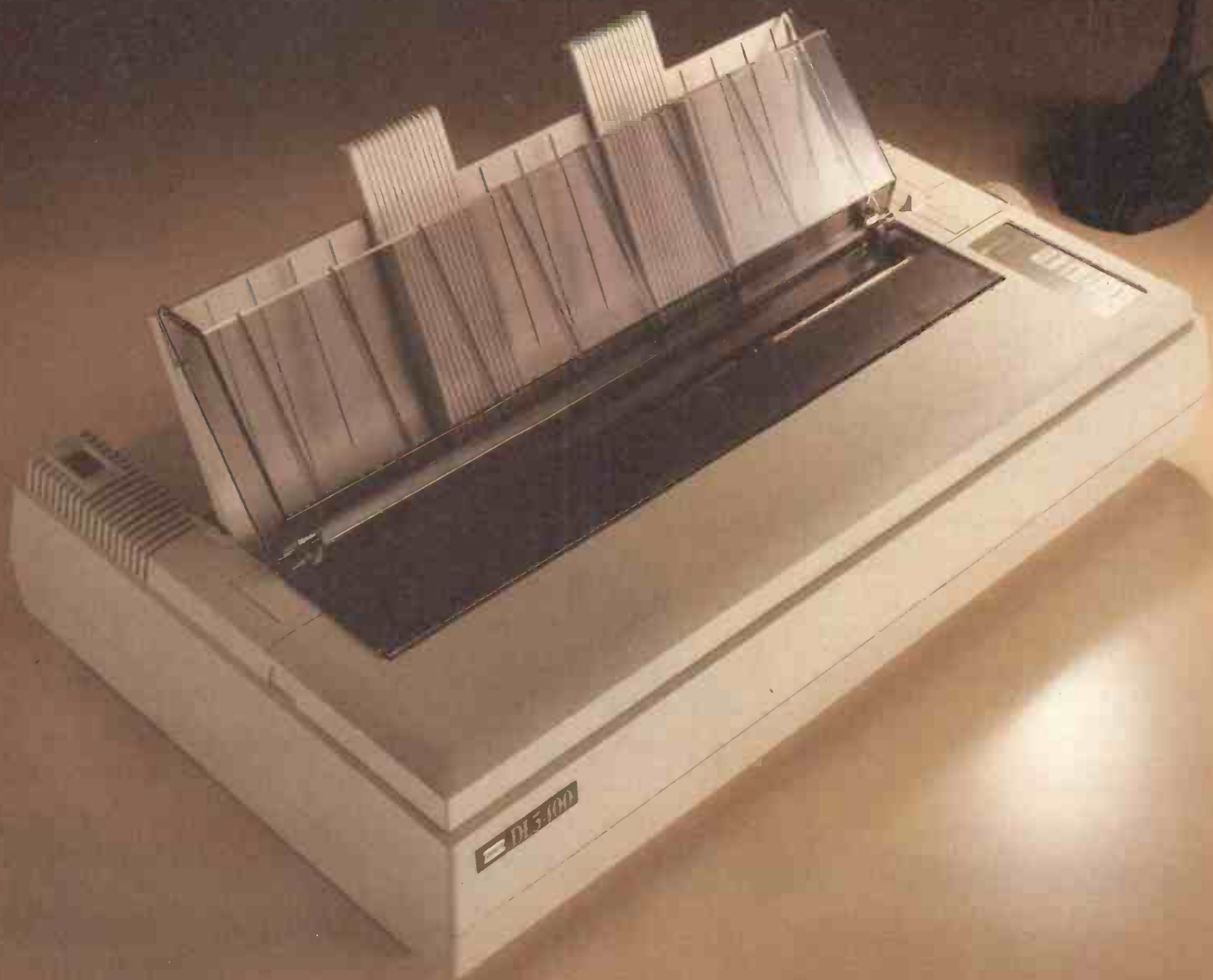

Don't get us wrong; it's a very fine printer, one of the finest you can buy, in fact. It's called the *Fujitsu DL3400*.

It's made by the number one computer maker in Japan, and so, as you might expect, it comes with a range of excellent features.

Like *speed* (amazing speed: it'll do 240 CPS in draft mode, and 60 CPS in letter quality).

And *clarity* (remarkable clarity: its 24-wire printhead produces diamond-sharp printouts).

And *variety* (wondrous variety: up to *eight* different type-fonts and a color printing option).

It also comes with a smooth and effortless paper handling system (featuring a built-in rear-feed tractor unit), instant hardware compatibility with just about any name brand computer on the market, heart-warming reliability, and a shocking price.

Shocking?

Even worse! Downright unbelievable! No printer offering all of this could have a price like this one. Could it?

Now you know the truth. To find out what it means, call Fujitsu on (44-1) 573-4444. Or write to: *Fujitsu Europe Ltd., 2, Longwalk Road, Stockley Park, Uxbridge, Middlesex, UB11 1AB, England.*

Japan's No. 1 computer maker

FUJITSU

I'd like to know more about Fujitsu printers.

Please send information on the following:

- DL3400** (24-wire dot matrix)
- DL2600** (24-wire dot matrix)
- DL2600 Color** (24-wire dot matrix)
- DL2400** (24-wire dot matrix)
- DL2400 Color** (24-wire dot matrix)
- DX2200** (9-wire dot matrix)
- DX2100** (9-wire dot matrix)

Name: _____

Title: _____

Company: _____

Address: _____

City: _____ Country: _____

Phone: _____ Fax: _____

Send to:

Fujitsu Europe Ltd. 2 Longwalk Road, Stockley Park, Uxbridge, Middlesex, UB11 1AB, England. Phone: 01-573 4444

Practical Computing June

→ circle 117 on enquiry card ←

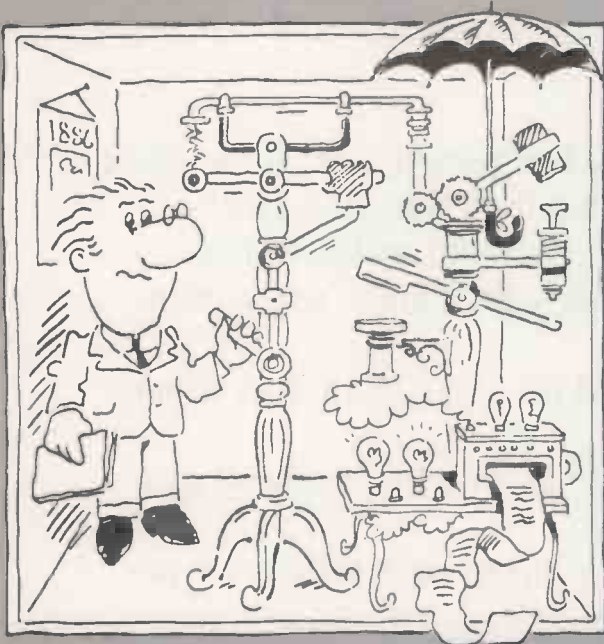

WHO'S GOT THE AUTOMATIC T-SWITCH?

For several years manual data switches have established themselves as a cost effective item in the time they save in reconfiguration, simply by the rotation or pushing of a switch.

However, with the autoswitch, once connected you need never touch it again.

Autoswitch has the ability to connect several data sources up to two printers or a number of terminals to a modem etc.

Switching is obtained either on a demand basis (first come, first served) or a simple typed instruction directly from your PC's keyboard or embedded in the print data to select which peripheral you require to use.

When using autoswitch with several PC's sharing a common peripheral an in-built 10 second time-out feature prevents users from attempting access at the same time, with the ability to scan an entire system 10 times per second.

The reliability of solid state circuitry and for around the price you would expect to pay for a manual switch. Why get left behind!

Available in RS232 or centronics versions.

Call Interface Systems today.
We'll get you connected.

INTERFACE SYSTEMS, OF COURSE. PRICES FROM £120

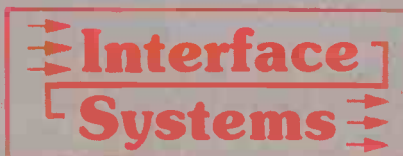

Price quoted excludes VAT

Interface Systems · Unit 11 · Conqueror Industrial Estate · Moorhurst Road · Castleham · Hastings · Sussex
Tel: (0424) 52682 · Telex: 265871 (MONREF G) Quote Ref 83: CRD 0038

Available from:
Farnell Electronic Components
Canal Road
Leeds LS12 2TU
Tel: (0532) 636311

Clwyd Technology Ltd
Hambro House
Vinters Place
London EC4V 3BA
Tel: 01-236 1543

A>Line Dataspeed
Devices Ltd
3 Auburn Road, Blaby
Leicester LE8 3DR
Tel: (0533) 778724

Northamber
Unit B5, Lion Park Avenue
Chessington
Surrey KT9 1FT
Tel: 01-391 2066

CARBON COPY

ACTION AT A DISTANCE

By Mike Lewis

This comms package allows you to take control of a PC at the far end of a phone line, or watch what its user is doing.

Imagine you work for a software house supporting users of an application package. A customer at the other end of the country calls you with a problem that is too complex to deal with over the phone. You are faced with a choice of unsatisfactory options: travelling to the user's site, or trying to reconstruct the problem on your own system.

A third option would be to use a modem to connect you to the customer's machine. This would be simple with a terminal-based multi-user system because you can log on like any other user, but it will not work if the remote computer is a PC. The only way for PCs to talk to one another is with suitable communications software at both ends. But of course if the distant machine is running a comms program it cannot also run the program that you are trying to debug.

This is the problem which Carbon Copy aims to solve. Carbon Copy consists of two modules, one of which remains in memory at the same time as the main application. The remote users loads it at the start of the session, and can then forget about it. The other module is run as a normal transient program by the local user, who is the person providing the support.

Although each Carbon Copy package includes both modules, you have to buy a separate copy for each machine. To discourage illegal copying, the program will not work if the versions at each end of the link have the same serial number.

After the local user has invoked their part of the package, they press f1 to initiate the connection. They then type the remote user's telephone number and password, and Carbon Copy proceeds to make the call. For this to work properly, there must be an auto-dial modem at one end and an auto-answer modem at the other. We had no difficulty with the two Miracle Technology WS-3000s that we used for this review. You should be able to use manual modems by configuring the software for a hard-wire connection, but the receiving modem must still be capable of working in answer mode.

Once the connection has been made, the local user sees an exact copy of what is on the remote user's screen. From then on, the software running on the remote system will respond to keystrokes typed at either key-

board, sending its video output to both screens at the same time.

Clearly this can only work properly if the two users co-ordinate their actions. In particular, they must avoid typing conflicting instructions at the same time. Either person can invoke a control screen by pressing Alt and the right-hand Shift. This suspends the application program and allows the users to type messages to each other. The application resumes when f10 is pressed.

As well as having access to the remote system's keyboard and screen, the person providing support can also take control of its printer and disc drives. Printed output from the application under test can be spooled and then sent to a printer at either end of the link. To cater for different types of printer,

CARBON COPY				
PC VERDICT				
	POOR	AVERAGE	GOOD	EXCELLENT
Performance	<input type="checkbox"/>	<input type="checkbox"/>	<input checked="" type="checkbox"/>	<input type="checkbox"/>
Ease of use	<input type="checkbox"/>	<input type="checkbox"/>	<input checked="" type="checkbox"/>	<input type="checkbox"/>
Documentation	<input type="checkbox"/>	<input checked="" type="checkbox"/>	<input type="checkbox"/>	<input type="checkbox"/>
Value for money	<input type="checkbox"/>	<input type="checkbox"/>	<input checked="" type="checkbox"/>	<input type="checkbox"/>

If supporting remote users is your problem this package could well be the solution.

the package includes a filter which converts the Escape sequences of any of 30 popular printers to any other.

The support person can also carry out disc operations, such as moving between directories and deleting files on either machine. This is done by entering DOS-like commands into the control screen. Normal disc-drive letters are used, prefixed by L and R for local and remote respectively. Files can be transferred across the link via a Copy command. All these functions can be performed without quitting the main application.

As well as providing long-distance diagnostics and support, Carbon Copy has a number of other potential uses. You could use it to allow a scattered workforce to access files on a central machine, for example. However, there is a problem with security. The software caters for passwords and has optional dial-back but there is no way of allowing access to some of the machine's resources but not others, which might rule out the package for some tasks.



SPECIFICATION

Description: communications software, intended primarily for remote diagnostics and support

Hardware required: IBM PC, PC/AT or compatible; local system needs 128K RAM; remote system needs 128K plus whatever RAM is needed by the program being supported; the two systems must be linked via modems or a direct connection

Copy protection: none

Price: £149

Publisher: Meridian Technology of Newport Beach, California

U.K. distributor: Software Ltd, 2 Alice Owen Centre, 251 Goswell Road, London EC1V 7JQ. Telephone: 01-278 2377

Available: now

The particular advantage of using Carbon Copy rather than a more general-purpose comms program for transfer is that it allows you to get right into the application. You are not limited to transferring an existing file, but can actually get a database package running and extract the information you are interested in, or enter a word processor and pull out the precise passage you want. But while this ability is impressive, it is a minority requirement. Support staff are likely to be the main users of Carbon Copy.

CONCLUSIONS

■ Carbon Copy allows you to operate a remote system as if it were on your own desk. It makes an effective tool for diagnostics, support and monitoring of application programs on remote PCs.

■ The package is simple in concept and easy to use. It does one job, and does it well. **PC**

LOOK!

INTRODUCING THE NEW GPR-2000 DAISYWHEEL PRINTER

AMAZING VALUE!



The ideal letter quality printer for reports and general correspondence. Manufactured in Japan. Complements all modern PC's

THE VERY LATEST DESIGN WITH UP TO THE MINUTE STYLING

- ★ 18cps printing speed
- ★ Variable line spacing
- ★ 10, 12 & 15 pitch
- ★ 96 char daisywheel
- ★ Interface - parallel standard
- ★ RS232 option
- ★ Qume compatible
- ★ Paper-max 13" wide
- ★ Front panel controls
- ★ Low noise 58dB(A)
- ★ Bi-directional logic seeking print system
- ★ Supports Wordstar commands
- ★ Tractors & S/Feeder option

THE PRICE OF SIMILAR MODELS

ONLY **£199** +VAT + P&P **Plus FREE**

- ★ 10 & 12 pitch daisywheels
- ★ Spare ribbon cassette
- ★ Dust cover
- ★ Detailed user manual & mains lead
- ★ Interface cable to your computer
- ★ £10 voucher for VOLKSWRITER de Luxe word processor

NO QUIBBLE - FULL MONEY REFUND IF NOT DELIGHTED

Internationally available ribbons and daisywheels guarantee low running costs.



The GPR - 2000 accepts Qume fabric or film ribbon cassettes

Wide choice of Qume compatible daisywheels

DATAPLUS

DATAPLUS (Sales) Ltd. PO Box 122, CHELTENHAM, GL51 8QL

TELEPHONE ORDERS **0242 573573** 24 HR

DATAPLUS (Sales) Ltd. PO Box 122, CHELTENHAM, GL51 8QL

Please supply GPR 2000 Daisywheel printers at £228.85 each incl. VAT. plus £8.50 courier delivery and insurance.

cheque Access Visa

Expiry date _____

Name _____

Address _____

Post Code _____

Daytime Tel No. _____

Reg in England 2080289

→ circle 119 on enquiry card ←

MANUAL & AUTOMATIC DATASWITCHES AND BUFFERS FULL TWELVE MONTHS GUARANTEE



"PRINTERSHARER" Several Micros to one Printer
 "PRINTERCHANGER" one Micro to several Printers
 "PRINTERCROSSOVER" Two Micros to two Printers

PARALLEL PRINTERSHARER SOLID STATE MANUAL

Model	Pins	Ways	Price
BPS3	26	3	£60
BPS3C	WITH INTERLINKS		£75
BP56	26	6	£110
BP56C	WITH INTERLINKS		£140
APS2	36	2	£75
APS3	36	3	£85
IPS2	25D(IBM)	2	£70
IPS3	25D(IBM)	3	£80

PARALLEL PRINTERCHANGER SOLID STATE MANUAL

BPC3	26	3	£60
APC2	36	2	£75
APC3	36	3	£85
IPC2	25D(IBM)	2	£70
IPC3	25D(IBM)	3	£80

SERIAL PRINTERSHARER/CHANGER

SR232	25D	2 way	£65
SR233	25D	3 way	£65
SR234	25D	4 way	£75
SR43	5DIN(BBC)	3 way	£40
SR292	9Din(Mac)	2 way	£52
SR293	9Din(Mac)	3 way	£59
SR2C	5DIN(1/c)	3 way	£40

AUTOMATIC PRINTERSHARER

APS2A	Parallel 36 pin	2 way	£110
APS3A	Parallel 36 pin	3 way	£115
IPS2A	Parallel 25D(IBM)	2 way	£95
IPS3A	Parallel 25D(IBM)	3 way	£110
SR234A	Serial 25D	4 way	£245

PARALLEL PRINTERCROSSOVER SOLID STATE MANUAL

BPX	26	2X2	£70
APX	36	2X2	£95
IPX	25D(IBM)	2X2	£85

SERIAL PRINTERCROSSOVER

SR23X	Serial RS232-25D	£70
R432X	Serial 5 pin DIN	£45
SR29X	9 Pin D. (Mac)	£62
SR2CX	5 Pin DIN (1/c)	£45

PARALLEL PRINTER BUFFER/SHARER

Input	Output	Price
PB64	Parallel Parallel 64K	£140
PB64-2	Above with 2 way switch	£185
BF64U	Universal-64K expandable	£220
BF64D	Parallel Parallel 64K expandable with 2 printer ports	£249
PB256	Parallel Parallel 256K	£190
PB256-2	Parallel Parallel 256K with 2 way switch	£235

MULTIPOINT BUFFERS

BF64MD-PP	4 Parallel input 2 parallel output with 256K buffer	£345
BF64MD-4S	4 Serial input 2 Serial output with 256K buffer	£415

ACCESSORIES

KSM101	Serial to Parallel Converter with PSU	£65
KSM104	Parallel to Serial Converter with PSU	£70
KSM108	Dataflow Booster	£40
KSM109	Centronics with PUS Dataflow Booster	£40
KSM110	Serial RS232-V24 with PSU Multi-Link Serial Switch Selectable Cable	£50

CABLES (6ft. Long)

KPC104R	Ribbon cable 36 pin-36 pin	£12
KPC104F	Flex cable 36 pin-36 pin	£16
KPC105	Flex for IBM 25 pin-36 pin	£15
KPC106	Flex (25 lines) 25 pin-25 pin	£14
KPC101	Flex (12 lines) 25 pin-25 pin	£12

Add postage: Switches & Buffer £3.00 each, & cable £0.75p each + 15% VAT

KEYZONE LIMITED
 U14, Acton Business Centre
 School Road, London NW10 6TD
 Telephone: 01 965 1684/1804
 Telex: 881 13271 GECOM



Eliminate manual switching with AUTOSWITCH The automatic choice

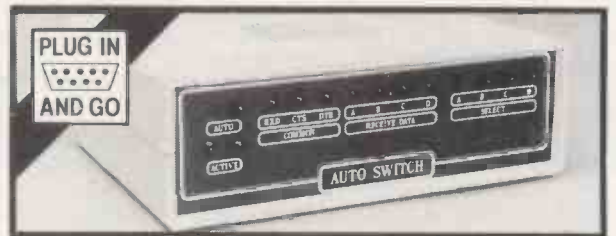

- * Will operate with all BAUD rates and DATA standards WITHOUT being configured via internal links or switches.
- * Can be used in AUTO or MANUAL modes.
- * Use with up to 4 PC's sharing 1 Laserjet, telex or draft printer.

EAS 410 Serial Autoswitch **£120**

EXP 410 will also support xon/xoff **£160**

Manual included

A603 Autoswitch to printer cable suits most items **£12.50**

Prices + VAT carnage paid

Trade enquiries welcome
 Ex stock for immediate delivery

HOMESTEAD DATA PRODUCTS LTD

145 EDINBURGH AVENUE, SLOUGH SL1 4UA
 Fax (0753) 691037 Telex 846086 CABLING
 Tel: (0753) 691661

©1987

→ circle 121 on enquiry card ←

→ circle 120 on enquiry card ←

LOW-COST SPREADSHEETS OUT ON A LIMB

By Glyn Moody

The Lotus user interface has been adopted by so many packages that users could be forgiven for believing that there is no other way to drive a financial-planning program. These cut-price packages attempt to prove them wrong.

The recent brouhaha over alleged infringements of Lotus's copyrights in 1-2-3 have tended to emphasise the clone approach to spreadsheets. But there are alternatives. The wave of IBMulators, led in this country by the Amstrad PC, has encouraged smaller software houses to try their hand with spreadsheets which do not necessarily toe the Lotus line.

This individuality may be appropriate for the home user of such machines, but for companies there need to be pretty strong reasons for straying from the established straight and narrow. Unless a package offers significant new features, the extra effort involved in learning and using a non-standard interface is simply not economic. And with each passing month, the argument for sticking with at least a Lotus work-alike becomes stronger, as more software in other fields adopts a similar interface, and so pre-supposes at least a nodding acquaintance with the general principles.

This drift towards Lotus is doubly unfortunate in the case of an innovative but non-standard package like Money Power. This is a slightly upgraded re-issue of a British program originally called FT Moneywise, first launched in 1983. It still uses a tiresome key disc to prevent copying. Without the presence of the disc the spreadsheet is severely limited in its extent.

Money Power offers a radically different approach to spreadsheets by taking into account how they are used in a business and building the program accordingly. The software sets up what it calls moneybooks, which are collections of related data. As well as the figures held on the spreadsheet itself, there is an opening cover page, a contents page outlining the information which follows, a key page which shows how the various sets of figures were derived, and graphs and tables.

This approach shows an admirable understanding of the needs of business users,



and could potentially prove very useful. Unfortunately what is an exciting concept is marred by the details of its implementation. In part, the program tries to be too clever. There are a wide range of commands which can be called up from the entry line by typing in two letters. Function keys play a vital role, together with a range of on-screen menus, single-letter commands, and the Esc key. To the designers of Money Power it is doubtless highly logical; to this hardened user of 1-2-3 it was totally bemusing.

It could be argued that comparing the software with Lotus's product is retrograde and unfair. But unfortunately, life is unfair: Lotus may not be the right standard, or even a relevant standard, but it is the one we are lumbered with. As a result, the time spent mastering Money Power is only going to be of use for that program. Working with a product following the Lotus conventions prepares you for much else in the domain of business software.

That said, Money Power is clearly an impressive piece of design. In some respects it is similar to Javelin, the extended spreadsheet reviewed in the May 1986 issue of *Practical Computing*, except that Javelin is nearer to 1-2-3 in its command structures. The ability to switch between the numbers on a spreadsheet, the relations that lie behind them, and graphs which lay bare the hidden trends, is valuable. Similarly, the bringing together of all the elements in a management report is sensible. It is a pity that Lotus got there first with a manifestly less powerful product, but one which caught on and still defines the standard against which Money Power must be measured and — in the last analysis — can only be found wanting.

Another British product, Swift, goes some of the way towards recognising the existence and well-nigh omnipotent nature of this standard. The on-screen appearance looks remarkably Lotus-like, except that there is

(continued on next page)

For viewing only :

CONTENTS OF THE MONEYBOOK		
TYPE	NO.	TITLE
KEY	K	Key to model
MODELLING	M01-M03	Range of modelling pages in use
SUMMARY	S01	MONEYPOST SUMMARY
GRAPH	G01 G02 G03	NET PROFIT vs MONTHLY CASH FLOW PROFITABILITY HISTOGRAM OF BUSINESS
PRESENTATION	P01	QUARTERLY REPORT

The contents page in Money Power's moneybook.

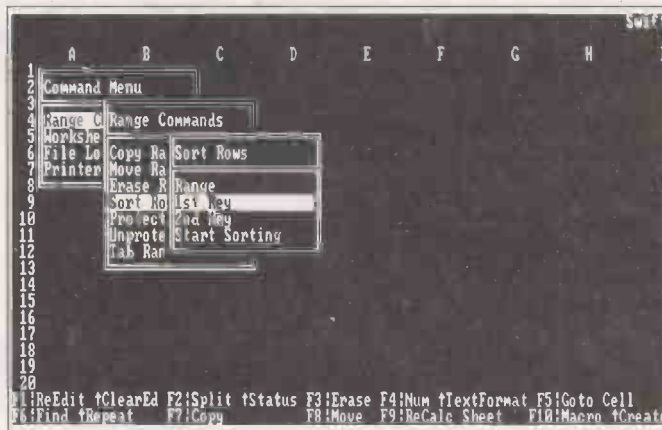

Swift's pull-down menus overlap.

MONEY POWER

PC VERDICT

POOR AVERAGE GOOD EXCELLENT

Performance	<input type="checkbox"/>	<input type="checkbox"/>	<input checked="" type="checkbox"/>	<input type="checkbox"/>
Ease of use	<input checked="" type="checkbox"/>	<input type="checkbox"/>	<input type="checkbox"/>	<input type="checkbox"/>
Documentation	<input type="checkbox"/>	<input type="checkbox"/>	<input checked="" type="checkbox"/>	<input type="checkbox"/>
Value for money	<input type="checkbox"/>	<input checked="" type="checkbox"/>	<input type="checkbox"/>	<input type="checkbox"/>

Potentially powerful but awkward to use.

SWIFT

PC VERDICT

POOR AVERAGE GOOD EXCELLENT

Performance	<input checked="" type="checkbox"/>	<input type="checkbox"/>	<input type="checkbox"/>	<input type="checkbox"/>
Ease of use	<input type="checkbox"/>	<input type="checkbox"/>	<input checked="" type="checkbox"/>	<input type="checkbox"/>
Documentation	<input type="checkbox"/>	<input checked="" type="checkbox"/>	<input type="checkbox"/>	<input type="checkbox"/>
Value for money	<input type="checkbox"/>	<input checked="" type="checkbox"/>	<input type="checkbox"/>	<input type="checkbox"/>

Its main virtues are simplicity and low cost.

MULTIPLAN JUNIOR

PC VERDICT

POOR AVERAGE GOOD EXCELLENT

Performance	<input type="checkbox"/>	<input checked="" type="checkbox"/>	<input type="checkbox"/>	<input type="checkbox"/>
Ease of use	<input type="checkbox"/>	<input checked="" type="checkbox"/>	<input type="checkbox"/>	<input type="checkbox"/>
Documentation	<input type="checkbox"/>	<input type="checkbox"/>	<input checked="" type="checkbox"/>	<input type="checkbox"/>
Value for money	<input type="checkbox"/>	<input checked="" type="checkbox"/>	<input type="checkbox"/>	<input type="checkbox"/>

Only for sentimentalists and connoisseurs of software history.

(continued from previous page)

no menu at the top of the screen. Instead, commands are assigned to function keys shown along the bottom of the screen. Pressing a function key calls up a pull-down menu. Selecting from that menu either by using the cursor key or initial letters, brings up another, overlapping menu, and so on. The effect is visually clear and quite pleasing.

There is a macro facility which you initiate and terminate by pressing Shift and F10. Unlike Lotus macros, which can be assigned to a letter, Swift macros are given special names. The functions available are rather limited compared with Lotus's product. One of them is a graphing function, which is used instead of a graphing command or program. In operation it is rather fiddly, and the results do not compare with 1-2-3 or its clones.

All in all, Swift emerges as a competent enough program without obvious bugs. But the question remains as to why you should want to buy it in preference to one of the 1-2-3 clones such as VP-Planner, The Twin or Words & Figures: each of them offers practically full 1-2-3 compatibility, with the added bonus of a database, extended graphics and word processor respectively. Swift is about half the price of these clones, but the eventual savings in time and energy achieved by choosing a clone could be great. In many respects non-standard programs like Swift are dinosaurs which hark back to the bad old days of computing when every program was a convention in itself. Life may be rather more boring nowadays, but it is a lot simpler.

Microsoft's Multiplan Junior certainly is something of a fossil. It is a repackaging of Multiplan — a package first released in

1982. This time it is in a paperback form, along the lines of Adam Osborne's Paperback Software series. Unlike many other programs, it is not a cut-down version, for which credit must be given to Microsoft. But then cynics might argue that a program that old does not need to be.

The Multiplan command approach was never one of the happiest, and it is certainly complicated compared to Lotus. The release of this Junior version is probably a prelude to a full version of Excel — currently on the Mac — appearing for the IBM family and replacing Multiplan completely as Microsoft's front-line spreadsheet product. Although it is strictly non-standard as far as 1-2-3 is concerned, it does have the advantage of being thoroughly tried and tested, and from about the most experienced software house around. If you really must buy a cheap and simple spreadsheet, and are totally allergic to everything tainted by the Lotus bug, this is probably the one to go for.

SPECIFICATIONS

MONEY POWER

Description: extended spreadsheet with graphing and report facilities

Hardware required: IBM PC or compatible with 256K RAM

Copy protection: key disc required; absence limits spreadsheet size

Price: £86.09
Publisher: Moneywise Software, 699 London Road, North Cheam, Surrey SM3 9DL. Telephone: 01-337 0663

Available: now

SWIFT

Description: spreadsheet with basic graphics and database

Hardware required: IBM PC or compatible with 256K RAM

Copy protection: none
Price: £43.40

Publisher: Metamorphosis Developments, PO Box 333, Reading, Berkshire RG7 4BZ. Telephone: (0734) 303078

Available: now

MULTIPLAN JUNIOR

Description: Basic spreadsheet with some database functions

Hardware required: IBM PC or compatible, 128K RAM

Copy protection: none
Price: £69.95

Publisher: Microsoft, Excel House, 40 De Montfort Road, Reading, Berkshire RG1 8LP. Telephone: (0734) 507624

Available: now

CONCLUSIONS

■ Given the total dominance of the Lotus approach in not just the spreadsheet domain, but also increasingly outside it, you need to have strong reasons for not buying 1-2-3 or a clone.

■ Money Power may well possess enough virtues to justify such a move. However, getting to those virtues is a real effort.

■ Swift is a simple enough spreadsheet, with little particularly for or against it. Its user interface makes it easy to use.

■ Multiplan Junior has the advantage of Microsoft's backing plus years of proven service. Otherwise it is way off-beam. **PC**

TECHNOLOGY SO ADVANCED ...

MEMORY

- 512Kbytes RAM (520ST-M, FM)
- 1024Kbytes RAM (1040ST-F)
- 192Kbytes ROM
- 128Kbytes external plug-in ROM option

ARCHITECTURE

- Motorola 68000 Central Processing Unit (CPU) with a clock speed of 8MHz
- 16-bit external data bus
- 32-bit internal data bus
- 24-bit address bus
- 32-bit data & address registers
- 7 levels of interrupts
- 56 instructions
- 14 addressing modes
- 5 data types
- DMA (Direct Memory Access)
- real time clock as standard

GRAPHICS

- full bit-mapped display
 - palette of 512 colours
- Using Atari Monitors (on 520 & 1040):
- 640x400 high resolution - monochrome
 - 640x200 medium resolution - 4 colours
 - 320x200 low resolution - 16 colours
 - 80 column text display (40 col low res)
- Using Domestic TV (on 520):
- 640x200 medium resolution - 4 colours
 - 320x200 low resolution - 16 colours
 - 40 columns x 25 line text display

SOUND AND MUSIC

- 3 programmable sound channels
- frequency programmable 30Hz - 125KHz
- programmable volume
- wave & dynamic envelope shaping
- programmable attack, decay, sustain, release
- Musical Instrument Digital Interface (MIDI)
- MIDI allows connection of synthesizers etc.

STANDARD SOFTWARE

- GEM desktop + TOS operating system
- ST BASIC interpreter/language system

MOUSE

- high precision
- 2 button control
- free with 520ST-FM/1040ST-F
- non slip ball motion sensor
- removable ball for easy cleaning

INPUT/OUTPUT

- MIDI out (5 pin DIN) 31.25K baud
- MIDI in (5 pin DIN) 31.25K baud
- audio out 1.0V DC peak to peak, 10K ohm
- audio in 1.0V DC peak to peak, 10K ohm
- RGB monitor 1.0V DC, 75 ohm
- mono monitor 1.0V DC, 75 ohm
- mono horizontal scan rate 35.7KHz
- mono vertical scan rate 71.2KHz
- sync 5V DC (active low) 3.3K ohm
- modem/serial RS232C, 50 to 19,200 baud
- floppy disk 250 Kbits/s
- hard disk 11.3 Mbits/s
- mouse standard Atari connector
- joystick standard Atari connector
- cartridge port 128K capacity
- RF output (520ST-FM) for TV use

OPERATING SYSTEM

- TOS with GEM environment in ROM
- hierarchical file structure with sub-directories and path names
- user interface via GEM, with self explanatory command functions
- multiple windows + icons
- window resizing, re-positioning and erasing
- drop down menus (selected by mouse)
- GEM virtual device interface

COMMUNICATIONS

- RS-232C serial modem port
- 8-bit parallel printer port
- MIDI port (also for networking use)
- VT52 terminal emulation

KEYBOARD

- standard QWERTY typewriter format
- 95 full stroke keys
- 10 function keys
- 18 key numeric keypad + cursor keys
- variable auto-repeat & key click response
- keyboard processor reduces CPU overhead



... IT'S AFFORDABLE

ONLY FROM SILICA

Finally, there's a personal computer that not only solves problems like other computers, but also solves the one problem that other computers have created. Affordability. Silica Shop are pleased to present the ST range of personal/business computers from Atari. The ST was designed utilizing the most recent breakthroughs in semiconductor technology, producing a personal computer that performs tasks with fewer parts. Which means it costs less to make. And less to buy. The latest ST computers now include built in power supplies and built in disk drives. The TOS operating system and GEM window environment are now on ROM chips which are already installed in the ST keyboard. This enables automatic instant booting when you switch on. Silica Shop are pleased to offer the complete Atari ST range. Our mail order department is situated in Sidcup and we have 4 retail outlets at Sidcup, Orpington, Lion House (Tottenham Court Rd) and Selfridges (Oxford Street). We have eight years experience of Atari products, longer than any other UK company, and are well established as the UK's No.1 Atari specialist. With a group turnover of over £5 million and in excess of 70 staff, we provide unbeatable service and support. We provide several facilities which you will find invaluable during your Atari computing life and most of these facilities are available ONLY FROM SILICA. We suggest that you read through what we have to offer, before you decide where to purchase your Atari ST.

FREE STARTER KIT - Only From Silica

When you purchase any Atari ST keyboard, you will not only receive the best value for money computer on the market, but you will also receive the following from Atari Corporation as part of the package:

- BASIC Language Disk
- BASIC Manual
- ST Owners Manual
- TOS/GEM on ROM

If you buy your ST from Silica Shop, you will also receive:

- NEOchrome - colour graphics program
- 1st Word - Word Processor

In addition, we at Silica would like to see you get off to a flying start with your new computer, so we have put together a special ST STARTER KIT worth over £100, which we are giving away FREE OF CHARGE with every ST computer purchased at our normal retail prices. This kit is available ONLY FROM SILICA and is aimed at providing users with a valuable introduction to the world of computing. We are continually upgrading the ST Starter Kit, which contains public domain and other licensed software, as well as books, magazines and accessories all relevant to ST computing. Return the coupon below for full details.

DEDICATED SERVICING - Only From Silica

At Silica Shop, we have a dedicated service department of five full time Atari trained technical staff. This team is totally dedicated to servicing Atari computer products. Their accumulated knowledge, skill and experience makes them second to none in their field. You can be sure that any work carried out by them is of the highest standard. A standard of servicing which we believe you will find ONLY FROM SILICA. In addition to providing full servicing facilities for Atari ST computers (both in and out of warranty), our team is also able to offer memory and modulator upgrades to ST computers.

1Mb RAM UPGRADE: Our upgrade on the standard Atari 520ST-M or 520ST-FM keyboard will increase the memory from 512K to a massive 1024K. It has a full 1 year warranty and is available from Silica at an additional retail price of only £86.96 (+VAT = £100).

TV MODULATOR UPGRADE: Silica can upgrade the 1040ST-F to include a TV modulator so that you can then use it with your TV set. This is an internal upgrade and does not involve any untidy external boxes. A full time technical support team to help you get the best from your computer. Because which is only £49 (inc VAT). The upgrade is also available for early 520ST computers at the same price.

THE FULL STOCK RANGE - Only From Silica

We aim to keep stocks of all Atari related products and our warehouse carries a stock of £4 million. We import many software titles direct from the USA and you will find that we have new releases in advance of many of our competitors. Unlike dealers who may only stock selected titles, we have the full range. In addition, we carry a complete line of all books which have been written about the Atari ST. A range as wide as ours is something you will find available ONLY FROM SILICA.

AFTER SALES SUPPORT - Only From Silica

REST assured that when you buy your ST from Silica Shop, you will be fully supported. Our free mailings give news of releases and developments. This will help to keep you fully up to date with what's happening in the Atari market. And in addition, our sales staff are at the end of a telephone line to service all of your Atari requirements. If you purchase an ST from Silica and would like any programming or technical advice, we have a full time technical support team to help you get the best from your computer. Because we have both the staff and the systems specifically dedicated to providing after sales service on Atari ST computers, we are confident that our users enjoy an exceptionally high level of support. This can be received ONLY FROM SILICA.

FREE CATALOGUES - Only From Silica

At Silica Shop, we recognise that serious users require an in-depth information service, which is why we mail free newsletters and price lists to our ST owners. These are up to 48 pages long and are crammed with technical details as well as special offers and product descriptions. If you have already purchased an ST and would like to have our names added to our mailing list, please complete the coupon & return it to us. The information service is available ONLY FROM SILICA.

FREE OVERNIGHT DELIVERY - From Silica

Most orders are processed through our computer within 24 hours of receiving them. Most hardware orders are sent by the overnight METRO courier service FREE OF CHARGE to customers within the UK. This method helps to ensure minimum delay and maximum protection.

PRICE MATCH - Only From Silica

We hope that the combination of our low prices, FREE UK delivery service, FREE Starter Kit and FREE after sales support, will be enough to make you buy your Atari equipment from Silica Shop. If however, there is something you wish to purchase, and you find one of our competitors offering it at a lower price, then please contact our sales department, providing us with our competitor's name, address and telephone number. If our competitor has the goods in stock, we will normally match the offer (on a 'same product - same price' basis) and still provide you with our normal free delivery. We realise that we are not the only company who will match a competitor's price. However, if you come to us for a price match, you will also be entitled to our after sales service, including free newsletters and technical support. This makes our price match promise rather special, something you will receive ONLY FROM SILICA. We don't want you to go anywhere else for your Atari products. So shop at Silica, the UK's No.1 Atari Specialist.

- SIDCUP (& Mail Order)** 01-309 1111
1-4 The Mews, Hatherley Road, Sidcup, Kent, DA14 4DX
- LONDON** 01-580 4839
Lion House (1st floor), 227 Tottenham Court Rd, London, W1
- LONDON** 01-629 1234 ext 3677
Selfridges (1st floor), Oxford Street, London, W1A 1AB

520ST-M

The affordability of Atari computers is reflected in the price of the 520ST-M keyboard, which is a mere £259 (inc VAT). This version of the ST comes with 512K RAM, as well as a modulator and lead for direct connection to any domestic TV. The price does not include a mouse. In addition, when you buy your 520ST-M from Silica, you will also receive the FREE Silica 'ST Starter Kit'. During 1987, many software houses will be producing games software on ROM cartridges, which will plug directly into the cartridge slot on the 520ST-M keyboard, giving instant loading without the expense of purchasing a disk drive. With the enormous power of the ST, you can expect some excellent titles to be produced, making this the ultimate games machine! If your requirement is for a terminal, then the 520ST-M can fulfill this role too. Leads are available to connect the ST to a variety of monitors, and with the imminent introduction of terminal software on ROM cartridge, the ST provides a low price terminal for business use. If you wish to take advantage of the massive range of disk software available for the ST range, you will need to purchase a disk drive. Atari have two floppy disk drives available, a 1/2 Mbyte model £149 and a 1Mbyte model £199. Full details of these drives, as well as the Atari 20Mbyte hard disk are available on request. If required at a later date, the mouse may be purchased separately.

£259

520ST-FM

The 520ST-FM with 512K RAM and free mouse, represents a further breakthrough by Atari Corporation in the world of high power, low cost personal computing. This model is the latest addition to the ST family, and is not only powerful, but compact. It is priced at only £399 (inc VAT) a level which brings it within the reach of a whole new generation of computer enthusiasts. When purchased from us, it comes with the FREE Silica 'ST Starter Kit' see paragraph on the left. To make the 520ST-FM ready for use straight away, Atari have built into the keyboard a 1/2 megabyte disk drive for information storage and retrieval, allowing you easy access to the massive range of disk based software which is available for the ST. This new computer comes with all the correct cables and connections you will need to plug it straight into any standard domestic television set. You do not therefore have to purchase an Atari monitor. If you do require a monitor however, these are available with the 520ST in the following money saving packages:

- 520ST-FM Keyboard Without Monitor - £399 (inc VAT)
- 520ST-FM Keyboard + High res mono monitor - £499 (inc VAT)
- 520ST-FM Keyboard + Low res colour monitor - £599 (inc VAT)
- 520ST-FM Keyboard + Med res colour monitor - £699 (inc VAT)

Because the 520ST-FM has its own power transformer built into the keyboard, there are no messy external adaptors to clutter up your desk space. You are left with only one mains lead, serving both the disk drive and the computer. You couldn't ask for a more stylish and compact unit.

£399

1040ST-F

For the businessman and the more serious home user, Atari have their most powerful model, the 1040ST-F with 1028K RAM. This low cost powerhouse can be introduced into a business environment as a stand-alone system, or can support a mainframe computer as a terminal. The 1040ST-F not only features twice as much memory as the 520ST-FM, but also includes a more powerful built-in disk drive. The drive featured on the 1040ST-F is one megabyte double sided model. The extra memory facility of the 1040ST-F makes it ideal for applications such as large databases or spreadsheets. Like the 520ST-FM, the 1040ST-F has a mains transformer built into the console to give a compact and stylish unit with only one mains lead. The 1040ST-F is also supplied from Silica Shop with a free software package and 'ST STARTER KIT'. In the USA, the 1040ST-F has been sold with a TV modulator like the 520ST-FM. However, for the UK market, Atari are manufacturing the 1040ST-F solely with business use in mind and it does not currently include an RF modulator, this means that you cannot use it with a domestic TV (Silica Shop do offer a modulator upgrade for only £49). The 1040ST-F keyboard costs only £599 (inc VAT) and, unlike a modulator, a modulator upgrade is fitted, will require an Atari or third party monitor. There are three Atari monitors available and the prices for the 1040 with these monitors are as follows:

- 1040ST-F Keyboard Without Monitor - £599 (inc VAT)
- 1040ST-F Keyboard + High res mono monitor - £699 (inc VAT)
- 1040ST-F Keyboard + Low res col monitor - £799 (inc VAT)
- 1040ST-F Keyboard + Med res col monitor - £899 (inc VAT)

The 1040ST-F comes with a mouse controller and includes 1Mbyte of RAM. It has a 1Mbyte double sided disk drive and mains transformer, both built into the keyboard to give a compact and stylish unit, with only one mains lead.

£599

ATARI



To: Silica Shop Ltd. Dept PC 0687. 1-4 The Mews, Hatherley Road, Sidcup, Kent, DA14 4DX

PLEASE SEND ME FREE LITERATURE ON THE ATARI ST

Mr/Mrs/Ms: _____ Initials: _____ Surname: _____

Address: _____

Postcode: _____

Do you already own a computer
If so, which one do you own?



AMSTRAD PC SPECIAL OFFER

- 1512 DOUBLE DRIVE, COLOUR, 512K **RRP £729** **Our PRICE £679**
- 1512 S/DRIVE, 20MB NEC HD, COLOUR **£1,069** **£949**
- RAM UPGRADE TO 640K £28
- NATIONWIDE ON-SITE MAINTENANCE AVAILABLE

PANASONIC PC

- FX600 XT COMPATIBLE SERIES FEATURE 95 KEY KB, 8096.7, 16.4 77MHz. CLOCK, PARALLEL PORT, NON-PANASONIC HIGH-RES CARD & GREEN MONITOR, 6 SLOTS, MSDOS/GWBASIC
- FX600 SINGLE DRIVE, 640K, MONO **£1,099**
- FX600 DOUBLE DRIVE, 640K, MONO **£1,199**
- FX600 S/DRIVE, 20MB NEC HD, MONO **£1,499**
- SERIAL CARD £39
- J83301 TRANSPORTABLE, GAS PLASMA DOUBLE DRIVE, 512K, SER/PAR **£1,349**
- J83301 S/DRIVE, 20MB NEC HD **£1,749**

VICTOR PC

- FREE ONE YEAR NATIONWIDE ON-SITE MAINTENANCE ON ALL VICTOR SYSTEMS BY CBS
- VPC 2: DOUBLE DRIVE, 640K, MONO **£CALL**
- VPC 2: S/DRIVE, 30MB HD, MONO **£CALL**

HARD DISK UPGRADES PC/XT, AT & COMPATIBLES (INTERNAL)

- 20MB/30MB & CONTROLLER **£329/£449**
- 40MB & CONTROLLER (40MS ACCESS TIME) PC/XT **£699**
- 20MB - AT (WITHOUT CONTROLLER) **£299**
- 32MB - AT (40MS ACCESS TIME) WITHOUT CONTROLLER **£550**

HARD CARDS

- 20MB/30MB HARD CARD **£349/£399**

FAST 20MB CASSETTE BACKUP PC/XT, AT & COMPATIBLES £950

NOW ONLY £599 LIMITED OFFER

WHY USE SLOW CARTRIDGE BACKUP? CASSETTE NEEDS NO TIME WASTING SERVO WRITING OR FORMATTING. BACKS UP 20MB IN 4 MINUTES! INTELLIGENT MENU DRIVEN SOFTWARE - ONE KEY COMMANDS. FILE-BY-FILE BACKUP/RESTORE. IMAGE BACKUP/RESTORE. FILE DIRECTORY AND DIAGNOSTICS. SUPPLIED WITH CONTROLLER, CABLE, SOFTWARE AND MANUAL.



IBM PC/XT COMPATIBLE INTERFACE CARDS

MULTI I/O FLOPPY CARD: MIO 100 (SHORT SLOT) £79 PERFECT FOR THE 640K MOTHERBOARD

- 2 DRIVE FLOPPY DISK CONTROLLER - CABLE SUPPLIED
- 1 x RS232 SERIAL PORT & OPTIONAL 2ND SERIAL PORT (£16)
- PARALLEL PRINTER PORT
- GAMES PORT
- CLOCK/CALENDAR BATTERY
- SOFTWARE SUPPLIED: CLOCK UTILITIES



MULTI I/O CARD: OIO 200 XT (SHORT SLOT) £69 PERFECT FOR THE 640K MOTHERBOARD

- CLOCK/CALENDAR BATTERY
- 1 RS232 SERIAL PORT, 2ND SERIAL PORT OPTION (£16)
- PARALLEL PRINTER PORT
- GAMES PORT - CABLE SUPPLIED
- SOFTWARE SUPPLIED: CLOCK UTILITIES



MULTIFUNCTION CARD: CT 6050S WITH 8K RAM £99 WITH 384K RAM £149

COMPARE SPECS & PRICES BEFORE BUYING OTHER CARDS

- UP TO 512K RAM
- CLOCK/CALENDAR BATTERY
- 1 RS232 SERIAL PORT, 2ND SERIAL PORT OPTION (£26)
- PARALLEL PRINTER PORT
- GAMES PORT - CABLE SUPPLIED
- SOFTWARE SUPPLIED: CLOCK UTILITIES, RAMDISK, PRINTSPOLER

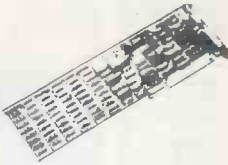

COLOUR GRAPHICS ADAPTOR WITH PRINTER PORT £79

FULLY COMPATIBLE WITH IBM COLOUR CARD

- 2 VIDEO INTERFACES: RGB COLOUR AND COMPOSITE MONOCHROME (NOT SUITABLE FOR IBM MONOCHROME MONITOR)
- COLOUR GRAPHICS MODE: 320 x 200
- MONOGRAPHICS MODE: 640 x 200

PARADISE ENHANCED GRAPHICS ADAPTOR (EGA) WITH AUTO SWITCH FOR MODE SELECTION - SHORT SLOT £225

COMPATIBLE WITH IBM EGA, IBM COLOUR GRAPHIC ADAPTOR, IBM MONOCHROME ADAPTOR AND HERCULES CARD

SUPPORTS MONOCHROME AND COLOUR MODES 640x350 MONO, 720x348 MONO, 640x350 COLOUR, 640x200 COLOUR. 256K RAM ON BOARD AS STANDARD -

GENIUS MOUSE (SERIAL) FOR PC/XT/AT £99

BOTH MICROSOFT & MOUSE SYSTEMS COMPATIBLE

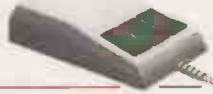

MONOCHROME GRAPHICS CARD £79

FULLY COMPATIBLE WITH IBM MONOCHROME ADAPTOR & HERCULES GRAPHICS

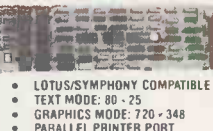

- LOTUS/SYMPHONY COMPATIBLE
- TEXT MODE: 80 - 25
- GRAPHICS MODE: 720 x 348
- PARALLEL PRINTER PORT

UNIVERSAL MEMORY CARD: CT6280

WITH 8K RAM £49 WITH 384K RAM £99 WITH 512K RAM £109



- UP TO 640K (YES 640K!) RAM ON BOARD
- USE 64K AND/OR 256K CHIPS
- USE 3 BANKS OF 256K CHIPS FOR TOTAL 640K RAM

RAM CHIPS

64K (9 CHIPS) 150NS £10
256K (9 CHIPS) 150NS £20/£30 (120NS)

2MB EMS CARD FOR PC/XT/AT £349 FULLY POPULATED WITH 2MB RAM

THIS CARD CAN GIVE YOUR PC/XT/AT BOTH EXPANDED MEMORY (LOTUS/INTEL/MICROSOFT EXPANDED MEMORY SPECIFICATION) AND THE EXTENDED MEMORY CAPABILITIES UP TO 2MB RAM. MEMORY CAN BE ALLOCATED AS CONVENTIONAL, EXPANDED OR EXTENDED MEMORY

PC/XT ASYNCHRONOUS SERIAL CARD WITH 1 RS232 PORT £29

PC/XT PARALLEL PRINTER CARD £29

FLOPPY DISK DRIVE ADAPTOR £39

IBM PC/AT COMPATIBLE INTERFACE CARDS

3MB MULTIFUNCTION CARD: MF 3000 WITH 8K RAM £179 FULLY COMPATIBLE WITH IBM AT AND COMPATIBLES ADD £30 PER 256K RAM

- UP TO 3MB RAM ON BOARD - 1.5MB ON MAIN BOARD AND FURTHER 1.5MB ON PICKYBACK BOARD
- MEMORY STARTING ADDRESS CONFIGURABLE AT 256K, 512K OR ABOVE 1MB
- 1 RS232 PORT - 2ND PORT OPTION
- PARALLEL PORT
- GAMES PORT



SERIAL-PARALLEL CARD FOR AT: WITH 1 SERIAL/2 SERIAL PORTS: £69/99

FLOPPY/HARD DISK CONTROLLER FOR AT £199

IBM COMPATIBLE ENHANCED KEYBOARDS - SWITCHABLE FOR PC OR AT £99

- SEPARATE CURSOR PAD
- FULLY PC/AT & AT COMPATIBLE - SWITCH SELECTABLE
- LED STATUS INDICATORS FOR CAPS & NUMBER LOCK
- 101 KEY



MONITORS

LATEST 14" FLATSCREEN PAPERWHITE MONITOR WITH TILT/SWIVEL £149



IBM COMPATIBLE
• COMPOSITE MONOCHROME - CONNECTS TO COLOUR GRAPHICS CARD £99

- IBM COMPATIBLE 14" PAPERWHITE TTL MONITOR £149
- IBM COMPATIBLE: 14" MITSUBISHI COLOUR MONITOR £249
- NEC MULTISYNC CGA/EGA/PGA MONITOR £525

VISA, ACCESS WELCOME

Ordering Information:

Prices are exclusive of Carriage & VAT. Please add 15% to Total Cost. Carriage: Systems & Subsystems £20, Drives & Keyboards £8, Boards £5, RAM Chips £1, Monitor/Printer £15. *Visit our brand new Showroom - off-street parking nearest tube Kilburn (Jubilee Line)

OPEN MON-FRI: 9.30am-5.30pm.

CLOSED FOR LUNCH 1-2pm.

CLOSED SATURDAY

1 Grangeway, Kilburn, London NW6 2BW

Tel: 01-625 0295/6/7/8/9 (5 lines)
Telex: 295173 MICROX G

micronix computers Ltd

micronix computers Ltd

LCS-8848: 3278/79 TERMINAL EMULATOR PC/XT/AT £549



- IRMA COMPATIBLE • HOST INTERFACE: PC/XT/AT
- NATIVE MODE COAXIAL CONNECTION TO IBM 3274/76
- 3278 MONO OR 3279 COLOUR EMULATION
- UP TO 3440 CHARACTER DISPLAY, 80 CHARACTER STATUS
- FILE TRANSFER UNDER TSO OR CMS • EAB SUPPORT
- ON BOARD CPU HANDLES 3270 PROTOCOL INDEPENDENTLY
- EASILY SWITCHES BETWEEN PC & 3278 EMULATION MODES
- LIGHT PEN SUPPORT • ASYNCHRONOUS CHARACTER INPUT SUPPORT

LCS-8261: ACCELERATOR CARD FOR PC/XT £299



- 8MHz 80286 CPU • 80286/8088 MODE SWITCHABLE
- 8KB HIGH SPEED ZERO WAIT CACHE MEMORY
- SUPPORTS 5 OR 8MHz 80287 COPROCESSOR
- HARDWARE SWITCHABLE 8088 REMAINS IN SYSTEM FOR FULL COMPATIBILITY • HARDWARE CACHE DISABLE
- AUTOMATIC CACHE DISABLE DURING SELF TEST FOR COMPATIBILITY WITH MOST BIOSes • SOFTWARE CAN RUN UP TO SEVEN TIMES FASTER
- NO SOFTWARE PATCHES NEEDED • RUNS ALL XT/AT SOFTWARE

THE BEST BUY PRINTER VP 1814 £199

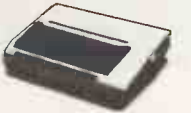

COMPARE SPECS AND PRICE OF THIS PRINTER BEFORE YOU BUY ANOTHER MAKE. IDEAL FOR AMSTRAD, IBM COMPATIBLES, BBC, ETC.

- EPSON/IBM COMPATIBLE - SWITCH SELECTABLE
- 180 CPS DRAFT/36 CPS NLQ (DIFFERENT FONTS AVAILABLE)
- BI DIRECTIONAL LOGIC SEEKING
- PROPORTIONAL SPACING
- ADJUSTABLE TRACTOR AND FRICTION FEED

POWER SUPPLY



150W

FOR PC/XT £89



220W

FOR AT £149

PRINTERS OUTSTANDING VALUE

PANASONIC KXP 1080 PRINTER ONLY £149

80 COLUMN 100 CPS/20 CPS NLQ HARDWARE NLQ SWITCH



PANASONIC KXP 1080: EPSON COMPATIBLE, 80 COLUMN, 100 CPS/20 CPS NLQ SPECIAL OFFER **£149**

PANASONIC KXP 1092: IBM/EPSON COMPATIBLE, 80 COLUMN, 180 CPS/33 CPS NLQ **£350**

PANASONIC KXP 1592: IBM/EPSON COMPATIBLE, 136 COLUMN, 180 CPS/38 CPS NLQ **£399**

PANASONIC KXP 1595: IBM/EPSON COMPATIBLE, 136 COLUMN, 240 CPS/51 CPS NLQ DUAL LF **£549**

PANASONIC KX3131 DAISY WHEEL **£275**

EPSON FX1000 136 COL. 200 CPS/40 NLQ F/T **£450**

EPSON SQ2500 INK JET **£1,099**

NEC P6: 24 PIN 80 COL. 216 CPS/72 LQ **£399**

NEC P7: 24 PIN 136 COL. 216 CPS/72 LQ **£499**

IBM PRINTER CABLE £13 (POSTAGE £2)



• OB25 TO CENTRONICS • SHIELDED CABLE - 3 METRE

FLOPPY DISK DRIVES 1/2 HEIGHT DS/DD 360K (PC/XT) **£99**
360K FOR IBM AT **£99**
1-2 MB FOR AT **£129**



MICRONIX MARVELS

**SMALL FOOTPRINT
& MARVELOUS PRICES**

286 MARVEL – SUPERFAST 10 MHz 'AT' COMPATIBLE TURBO

**1.2 MB FLOPPY
(READS & WRITES
360K DISK) AND
FAST 30MB
(40ms) HARD DISK
ONLY £1,799**

**WITH
20MB HD
£1,299**



14" PAPERWHITE
MONITOR
INCLUDED

MS DOS 3.2
AND GW BASIC 3.2
INCLUDED

■ 80286 -10 6/10MHz SWITCHABLE (10MHz, 0 WAITSTATE BENCHMARKED 11.5 PER NORTON - EQUIVALENT TO 12MHz) ■ 640K RAM (EXPANDABLE TO 1MB ON BOARD) ■ HI-RES MONOGRAPHICS CARD ■ HI-RES 14" PAPERWHITE MONITOR ■ 'AT' TYPE KEYBOARD ■ 1.2MB HIGH DENSITY FLOPPY ■ SERIAL & PARALLEL PORTS ■ FAST 30MB HARD DISK (40ms ACCESS TIME) ■ LEGAL LICENSED BIOS ■ 8 SLOTS ■ REAL TIME CLOCK/BATTERY ■ LICENSED MS DOS 3.2 GW BASIC RELEASE 3.2 AND MANUALS INCLUDED ■ SIZE: 390 x 362 x 153mm

NEW NEC MULTISPEED LAPTOP PORTABLE RRP: £1595 MICRONIX PRICE: £CALL

SUPERFAST 9.5MHz V30

LCD SUPERTWIST

BATTERY BACKED RAMDISK



■ LCD SUPERTWIST SCREEN ENSURES LEGIBILITY IN AVERAGE LIGHT WITHOUT EXCESSIVE BATTERY DRAIN ■ RUNS UP TO SIX HOURS FROM BATTERY ■ SUPERFAST 9.5MHz (SWITCHABLE TO 4.77MHz) V30 SUPERPROCESSOR-NORTON RATING 4.6 ■ PHOENIX BIOS ■ 640K RAM ■ 126K BATTERY BACKED RAMDISK ■ CLOCK/CALENDAR ■ 240V AC ADAPTOR ■ RGB OUTPUT ■ SERIAL & PARALLEL PORTS ■ EXTERNAL FDC PORT ■ 2 x 720K 3.5" FLOPPY ■ MS DOS 3.2 ■ SIZE: 13.6 x 12.4 INCHES ■ 11.2LBS OPTIONS: CAR LIGHTER ADAPTOR, LINK CABLE TO DESKTOP FLOPPY (ALLOWS SOFTWARE TRANSFER BETWEEN 5.25/3.5 INCH FLOPPY), CARRY CASE

PC MARVEL THE BEST OF 'XT' AND 'AT' IN ONE COMPACT SYSTEM

**PC MARVEL
TWIN 1.2MB
FLOPPY
(READS & WRITES
360K DISK) £749**

14" PAPERWHITE
MONITOR
INCLUDED

MS DOS 3.2
AND GW BASIC
INCLUDED

NEC V20
SUPERCHIP
INCLUDED



**PC MARVEL 1.2MB
FLOPPY (READS &
WRITES 360K DISK),
20MB HARD DISK
£999**

**30MB £1,199
40MB (40ms)
£1,399**

■ NEC V20 8/4.77MHz SWITCHABLE ■ 8 SLOTS ■ LEGAL LICENSED BIOS ■ CLOCK/CALENDAR & BATTERY ON BOARD ■ 1024K RAM - 640K RAM FOR DOS AND 384K RAMDISK ■ 2 x 1.2MB HIGH DENSITY 'AT' TYPE DRIVES (XT FLOPPY IS ONLY 360K!) OR 1 x 1.2MB FLOPPY AND HARD DISK ■ HI-RES MONO GRAPHICS CARD WITH PRINTER PORT ■ SERIAL RS232 PORT ■ COMPACT SIZE: 390 x 362 x 153mm ■ HI-RES 14" PAPERWHITE MONITOR ■ AT TYPE KEYBOARD ■ 360K DISKETTES CAN BE READ AND WRITTEN ONTO IN 1.2MB DRIVE AND FILES CAN BE COPIED BETWEEN 1.2MB & 360K DISKETTES AND VICE VERSA (EVEN IBM 'AT' CAN'T MANAGE THAT!) ■ LICENSED MS DOS 3.2 AND GWBASIC RELEASE 3.2 AND MANUALS INCLUDED

NEW NEC APC IV POWERMATE I 'AT' COMPATIBLE

**20/40MB (40ms) EGA SYSTEM:
RRP £2695/£2995
CALL FOR MICRONIX
SUPER PRICES**

**EGA CARD AS STANDARD
MULTISYNC CGA/EGA/PGA
MONITOR AS STANDARD
40ms HIGH SPEED
HARD DISK AS STANDARD
INCLUDES PRINTER CABLE**



■ 80286 8MHz-NORTON RATING 7.7 ■ PHOENIX BIOS ■ 640K RAM ■ CLOCK/CALENDAR ■ EGA CARD: 650 x 350 RESOLUTION-16 COLOUR ■ 14" NEC MULTISYNC CGA/EGA/PGA COLOUR MONITOR ■ ENHANCED 102 KEY KEYBOARD ■ SERIAL & PARALLEL PORTS ■ PRINTER CABLE ■ MS DOS 3.2 ■ 1.2MB 5.25" FLOPPY ■ 20 OR 40MB HIGH SPEED (40ms) HARD DISK ■ 5 x 16BIT AND 1 x 8BIT SLOTS ■ 3.5 FLOPPY SLOT ■ SMALL FOOTPRINT: 16.5" x 16.5"

micronix
computers Ltd

1 Grangeway,
Kilburn,
London NW6 2BW
Tel: 01-625 0295/6/7/8/9 (5 lines)
Telex: 295173 MICROX G

Ordering Information:

Prices are exclusive of Carriage & VAT. Please add 15% to Total Cost. Carriage: Systems & Subsystems £20, Drives & Keyboards £8, Boards £5, RAM Chips £1. Monitor/Printer £15.

*Visit our brand new Showroom - off-street parking, nearest tube Kilburn (Jubilee Line) OPEN MON-FRI: 9.30am-5.30pm.
CLOSED FOR LUNCH 1-2pm. CLOSED SATURDAY.



→ circle 122 on enquiry card ←

KODAK DATASHOW BLOW UP YOUR DISPLAY

By Ian Stobie

No more than a handful of people can comfortably view an ordinary computer screen at once, but this LCD-based display sets out to provide a solution.

Kodak's Datashow is a flat liquid crystal panel which you lay on an overhead projector like a transparency. It connects via a cable to the display card in a PC. The idea is to project an enlarged image of the panel on to a wall or projection screen.

Datashow costs £1,175 and is designed to work with IBM-compatible computers and most types of overhead projector. The target market is company training departments, computer dealers and anyone else who has to demonstrate to a group of people what is happening on a computer screen.

Similar liquid crystal display systems are available from other suppliers. The distinctive characteristic of the Datashow, apart from the Kodak name, is its price. It is the first such display to get close to the psychologically important £1,000 mark.

For your money you get the LCD display panel itself, a small infrared hand controller and software written by a Kodak subsidiary called Sayett Technology. The panel measures about a foot square and is about 2in. thick. The central area looks like a sheet of glass but is in fact the liquid crystal display. You also get a mass of cabling, a power adaptor and two manuals. The whole lot comes in a neat fabric carrying case and weighs about 5lb.

Hooking it all up seems fairly complicated at first sight — the cable from the display panel, for example, ends in four plugs — but in practice it is straightforward enough. One plug goes into the D-connector of the

Colour Graphics Adaptor (CGA) card on your PC; you use another one to reconnect your monitor. This arrangement allows you to continue using your existing monitor while projecting the same image with Datashow. The two other plugs go to the power adaptor and a comms port on your PC. An optional £69 cooling fan unit can be fitted under one end of the display panel, though we left the machine with no fan running for most of a day without any apparent ill-effect.

When the power is switched on, the liquid crystal panel shows a translucent image that matches exactly what is on the computer screen. Place it on top of a working projector and you are in business. The computer and its monitor continue to work as normal, so if all you want to do is echo the monitor image on to a projection screen no further steps are necessary. You can even disconnect Datashow from your PC's comms port; this connection is only needed if you want to give a carousel-style presentation using the accompanying Kodak software.

Datashow will only work with those overhead projectors that shine light through transparencies laid on top of them, though this is by far the most common type. A few overhead projectors are designed to work by reflecting light of the top surface of paper artwork; this type of unit is not compatible with Datashow.

The brightness of the image projected depends on your overhead projector, and



SPECIFICATION

Description: liquid crystal display system for use with PC and overhead projector

Display: 640 by 200 pixels CGA compatible on 203mm. (8in.) x 152mm. (6in.) LCD

Weight: 2kg. (4.5lb.) including power adaptor

Software in price: memory-resident screen-capture program and utilities to set up carousel display

Hardware required: IBM PC, PC/AT or compatible running MS-DOS 2.0 or higher, with CGA graphics; overhead projector of transmissive type; requires at least 256K RAM and a serial port

Price: £1,175; fan is £69 extra

Manufacturer: made in U.S.A. for Eastman Kodak of Rochester, NY

U.K. suppliers: First Software, Intec 1, Wade Road, Basingstoke, Hampshire RG24 0NE; telephone, (0256) 463344.

Reflex, Viewpoint, Gardner Road, Maidenhead, Berkshire SL6 7RJ; telephone, (0628) 771414

Available: now

COLOUR OPTIONS

There are alternatives to Datashow, but obviously other liquid crystal systems suffer from the same lack of colour. Large colour monitors and projection systems are available, but they are much more bulky and therefore less portable than Datashow. They are also expensive.

Large monitors seem the best bet for colour. For just under £1,300 you can get a 27in. Sony monitor and the necessary adaptor. This is one of the cheapest systems, and is often seen at exhibitions, displaying software to a handful of visitors. It gives very good colour results but like the Datashow it only works at the standard scan rate, so you are restricted to CGA colour graphics or Hercules monochrome.

For presentations to larger gatherings you need to go to a full-scale projection system. Unlike Datashow they have their own lights and lens system. Sony does one of the cheapest, at just over £5,000, but most people rent them. Once again this is a standard scan-rate machine. To get a projection system that can cope with EGA graphics you need a machine like Sony's Multiscan or the Canadian-made Electrohome. They cost close to £10,000 with the necessary adaptors. All the systems are available from a specialist supplier such as Reflex.

with our well-used 3M unit the results were not impressive. Whatever the projector, the Datashow liquid crystal display imparts a greenish-blue cast to the white areas; the dark areas appear as a darker version of the same green-blue. A giant computer screen at the bottom of a murky pond would probably look similar. You can adjust the contrast to some degree using the Datashow's cordless hand controller. You can also invert the image so that dark areas show light and vice versa. But the range of contrast is still limited, and even with a top-class projector the results will probably never be as crisp as you would like.

Datashow has other obvious limitations. For a start, it only works in monochrome,



not colour. And it only works with CGA display cards or other cards which emulate CGA mode. We used it successfully with a proper IBM CGA card and with a Vega Deluxe card supplied by P&P Micro that emulates IBM's Enhanced Graphics Adaptor (EGA). It will not work with the basic IBM Monochrome Display Adaptor (MDA) card, with EGA cards in full EGA mode, or with any of the new higher-resolution cards which IBM is currently introducing.

nature of current liquid crystal technology. The Datashow has essentially the same kind of display as is fitted to lap portables like the Sharp PC-7100 reviewed in last month's issue. Colour LCDs are available, but they are not cheap and the results would probably not be worth the extra expense.

The Datashow's inability to support a full range of graphics standards is also a reflection of its scan rate. This is a fundamental characteristic of all displays which build up an image from a constantly updated pattern of dots. The Datashow will only work with cards that use the standard scan rate of 15.75kHz, which is why it will not work with the IBM MDA card; despite its apparently low specification the MDA uses a higher scan rate. Cards of EGA resolution or above also use a higher scan rate. If you want to know whether the Datashow will work with your system, the rule of thumb is that any card which required a non-standard, high-grade monitor will not be compatible.

Datashow will project an enlarged image of the screen display.

KODAK DATASHOW				
KODAK VERDICT				
	POOR	AVERAGE	GOOD	EXCELLENT
Performance	<input checked="" type="checkbox"/>	<input type="checkbox"/>	<input type="checkbox"/>	<input type="checkbox"/>
Ease of use	<input type="checkbox"/>	<input checked="" type="checkbox"/>	<input type="checkbox"/>	<input type="checkbox"/>
Documentation	<input type="checkbox"/>	<input checked="" type="checkbox"/>	<input type="checkbox"/>	<input type="checkbox"/>
Value for money	<input type="checkbox"/>	<input type="checkbox"/>	<input checked="" type="checkbox"/>	<input type="checkbox"/>
<input type="checkbox"/> Far from perfect in performance terms, but reasonable value given the cost of competing devices.				

Kodak clearly hopes that there is a big enough market interested in CGA-level software to make its product viable. Most spreadsheets, databases and word processors work fine in this mode; it is when you come to CAD, desk-top publishing and presentation-graphics software that you can run into problems. Most of these packages will run in CGA mode but results are not always satisfactory without the higher resolution.

Presentation graphics is clearly one of the main applications that people want a large-screen system for. The real problem with Datashow in this role is its lack of colour, and indeed its rather unsparkling per-

formance even in monochrome. People use presentation graphics to impress their audience, so Datashow's shortcomings are important here. Perhaps its most effective use in this context would be to display live sequences echoed from the computer screen, interspersed between conventional colour acetate transparencies of static text or graphs.

In a training role colour might matter less. You could use Datashow quite effectively to demonstrate a word processor or spreadsheet to a large audience. But most PC software now uses colour, and many corporate users standardise on colour systems, so even here the Datashow's monochrome display could be a limitation.

To set against its obvious inadequacies, Datashow is at least reasonably good value by the standards of the field — see box opposite. It also scores by being portable, although you obviously need an overhead projector before you can use it.

Kodak provides three utilities with the Datashow system. SM Captor is a memory-resident program which lets you grab images from other applications. SM Editor lets you rearrange the images into a sequence for presentation, and SM Player then lets you play them back automatically or under the control of the keyboard or the hand controller.

Once you have installed SM Captor you hit Ctrl, Alt and the minus key to invoke it. A prompt screen pops up over the application you are running on which you specify whether the image you want to capture is in 640 by 200 graphics, 320 by 200 graphics or so-called IBM standard mode, which seems to mean text. The correct choice is not always obvious to the user and while using our multi-mode card we managed to hang the system when trying to capture images.

SM Editor and SM Player are straightforward. You can specify the length of time each image will be shown, or alternatively you can use the keyboard or hand controller to trigger the next image in the sequence. You can also get presentations to cycle continuously without intervention. If you have set up several presentations and have SM Player running you can choose between them using the hand controller without going near the computer.

Documentation takes the form of two short manuals. A 19-page booklet describes how to set the system up, and there is a 48-page software manual, complete with an index. Both are quite easy to follow.

CONCLUSIONS

■ The idea of a portable, low-cost device which fits over an overhead projector is appealing, but in practice the projection quality you get with Kodak's Datashow is not very good.

■ The major limitation is lack of colour; you are also restricted to running software in CGA mode.

■ Large colour monitors are probably a better bet if you only need a small increase in image size. Full-blown projection systems are several times more expensive than Datashow. 

STOP!

WE'VE GOT THE
PRICES YOU NEED!

WHY PAY MORE?

CLIPPER	377	RRP 595
DATEASE	385	RRP 545
DBASE II	265	RRP 395
DBASE III PLUS	339	RRP 595
DELTA 4 PRO	365	RRP 545
FRAMEWORK II	330	RRP 550
FREELANCE PLUS	255	RRP 395
GENIFFER 3	219	RRP 295
JAVELIN	166	RRP 245
LOTUS 1-2-3 2.01	235	RRP 395
LOTUS MANUSCRIPT	249	RRP 395
MS MOUSE	125	RRP 175
MS WORD 3.1	269	RRP 425
MULTIMATE	194	RRP 395
MULTIMATE ADVANTAGE	259	RRP 495
PARADOX	345	RRP 550
QUICKSILVER	299	RRP 460
RAPID FILE	200	RRP 275
SAMNA IV	352	RRP 550
SMART 3.1	365	RRP 695
SUPERCALC 4	199	RRP 396
SUPERPROJECT PLUS	265	RRP 495
SYMPHONY 1.2	335	RRP 550
TURBO BASIC	59	RRP 70
WORD PERFECT 4.2	249	RRP 425
WORDCRAFT 3	309	RRP 475
WORDSTAR 2000 PLUS	275	RRP 549
WORDSTAR 2000 2.0	239	RRP 465
WORDSTAR PROFESSIONAL 4.0	205	RRP 399
XCHANGE	235	RRP 495

- This is a small selection – call for details!
- Fast delivery!
- Friendly professional service!
- Credit accounts available!
- Government/export orders welcomed!

0480 · 53044/413122

Elite Computer Systems

UNIT 2 · HALCYON COURT · ST MARGARET'S WAY
HUNTINGDON · CAMBS PE18 6DG

Prices shown are for IBM/compatibles. All prices subject to carriage and VAT and are correct at time of going to press

→ circle 123 on enquiry card ←

CROTAN

HAS THE ECONOMICAL ANSWER TO EXPENSIVE POWER FAILURES

'DEFENDER' UPS FOR YOUR IBM PC AND COMPATIBLES

A compact and lightweight unit offering protection against inconvenient power failures, voltage surges and spikes. The 'DEFENDER' is ideally suited to office environments and offers simple plug-in connection. Available in ratings of 400VA, 800VA and 1200VA with a minimum of 10 minutes power reserve.

CROTAN has a solution for every power line problem, ask for details.

Leaders in Power Protection for computers and other critical applications.

Please 'phone for details on: (0462) 36111

Also ask for information on our larger UPS ratings up to 600KVA and line conditioning equipment.

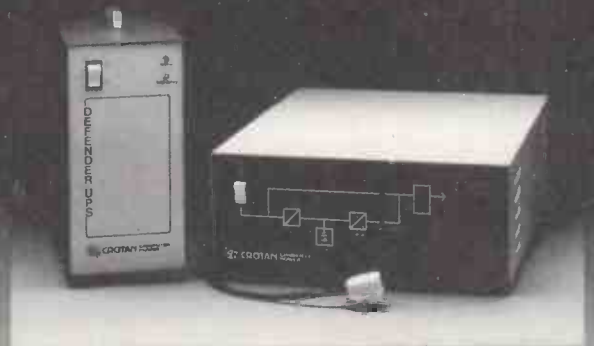

CROTAN ELECTRONICS LTD

New Bridge House, 33 Wilbury Way, Hitchin, Herts. SG4 0TW
England. Tel: (0462) 36111. Telex: 825244

→ circle 124 on enquiry card ←

The PR man was adamant: "We don't want you to write a piece about how we haven't exploited the discoveries made at Parc." What us? We wouldn't dream of such a thing. Anyway, the subject has been written about at dreary length elsewhere. We wanted to know what Xerox had in mind for us now.

Tony Saunders, public relations manager for Rank Xerox, was being unusually reticent. After all in one glorious period in the early to mid-1970s, the company devised Ethernet — with DEC and Intel — Smalltalk, the mouse and windows user interface, and the laser printer. Any company with that kind of track record is worth investigating for clues to how office technology is developing.

The Xerox Corporation has a revenue of around £6 billion, and it has traditionally devoted a large proportion of its income to R&D. Some £400 million was spent on research in 1986. Most of it goes on the famous Palo Alto Research Center (Parc). Under the auspices of its British subsidiary, Rank Xerox, the company has set up a European research centre in Cambridge, which will be devoted to investigations into artificial intelligence (AI). Xerox Corporation has a majority holding in Rank Xerox, which deals with the company's worldwide trade outside the Americas.

Rank Xerox's managing director, David O'Brien, indicated the company's direction in product development: "The idea was to design technology from the point of view of where it is going to be used. In other words, how do you get a user to use the technology."

This has been a strand in Xerox's thinking for many years now. The mouse and windows interface and Smalltalk were both designed to make computers more accessible to the user. In Xerox's view this approach now has to be translated into the office environment.

One of the problem areas identified by the company is to do with the different ways in which people and computers set about accomplishing their tasks. O'Brien explained: "Data processing is good for structured systems, but office systems are not structured. Rather, it should be oriented to the way people operate."

Office systems is the way in which the company sees the future pattern of business emerging. Xerox says it is moving away from the office automation (OA), networking and data-management techniques which have dominated research thinking in the 1970s and 1980s. The trend now is towards the integration of information, office and publishing systems.

Office systems (OS) differs from OA in that it integrates the various applications used in the office. Instead of having word processors, databases and spreadsheets as separate programs, all the applications co-exist on-screen. Equally important, data from one application can be transferred with the minimum of fuss to another.

Xerox's state-of-the-art implementation of these concepts is the Viewpoint desk-top

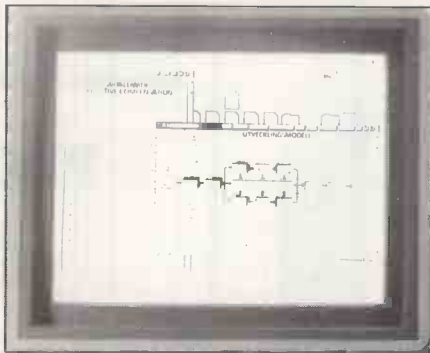

Viewpoint can have several different applications open and running at once.

OFFICE FUTURES

Xerox is continuing its policy of investing heavily in research. **Steve Malone** reports on where it is leading.

management system. It bears a striking resemblance to the Macintosh, although Viewpoint is much larger. Furthermore, unlike the Mac, Viewpoint can have several different applications open and running at once.

The Xerox approach differs from conventional office automation in some fundamental ways, as O'Brien explained. "We must unhook ourselves from OA and invest in OS in an integrated way. The difference between Xerox and Windows is in the integration. It supports overall activity rather than discrete activity, and removes the necessity for housekeeping activities."

The methodology that has been identified by Xerox is that information is gathered from several sources, and thought through and understood by users who then transmit their conclusions elsewhere. O'Brien told us: "Office users move from information acquisition to understanding to communi-

cations. The three attributes are integrated so that the user can interact with them. We provide support for all three processes." The support for the understanding process is one of the more intriguing aspects of Xerox's research. The idea behind Xerox's approach is to apply AI techniques to this aspect of office systems.

O'Brien explained to us that once a person had come to a set of conclusions about some data, AI processes could be applied to see if the conclusions were logical and consistent. "We are working on knowledge-based systems to support thought processing. Much of our research and development is oriented towards bringing AI to the office environment, but the more you bring AI to the office the more you have to concentrate on the way the human mind works. AI is about the recognition of relationships. It is used to test conclusions against a variety of data structures.

"For example, when data is pulled out you can qualify the relationship. By adding further qualifying relationships you build up a knowledge base. At present we are researching the applications, the tools and the way in which the user interacts with them."

Little of the research Xerox is carrying out has yet made its way into commercial products. However, some of the knowledge-based applications of Xerox's research are beginning to bear fruit.

The Kurzweil system is an intelligent document reader which, the company claims, can accept text in any type font. It uses a knowledge-based system which is said to understand what it is reading. It can therefore transmit information as a string of characters rather than as the block images used by fax machines.

Xerox has already made a major impact on the office market. Much of the equipment now taken for granted originated at Parc. With its concentration of research into knowledge-based systems and AI techniques, the company is moving towards a future in which the machines will not be mere tools in the office but full partners in the decision-making process. 



Xerox pioneered both the mouse and windows interface, and laser printers.

MicroSight

LOW COST IMAGE CAPTURE

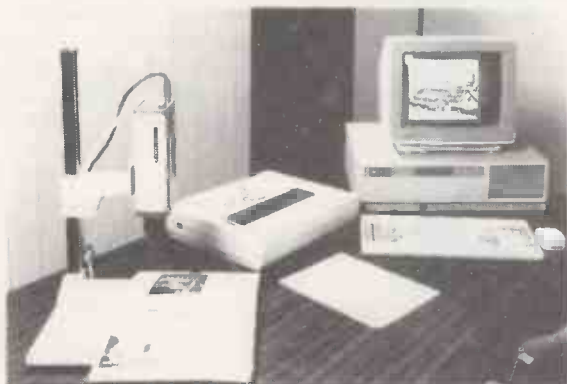

MICROSIGHT I

The popular low cost image capture system for IBM PC/XT/AT and compatibles capable of capturing up to 512 x 512 resolution images at 255 grey levels. MicroSight I includes camera, Microeye Scanner Card and software.

A camera stand is included to allow images of a variety of sizes to be captured **£595 + VAT**

MICROEYE SCANNER

Image capture card for use with your own camera/video system, provided with software for image capture, disk storage and printing. The microeye scanner has a resolution of up to 512 x 512 pixels at 255 grey levels.

Suitable for IBM PC/XT/AT and compatibles **£295 + VAT**

Versions of MicroSight and Microeye available for RM NIMBUS, Apricot, BBC Model B, HP 9816 and Victor 9000/Sirius

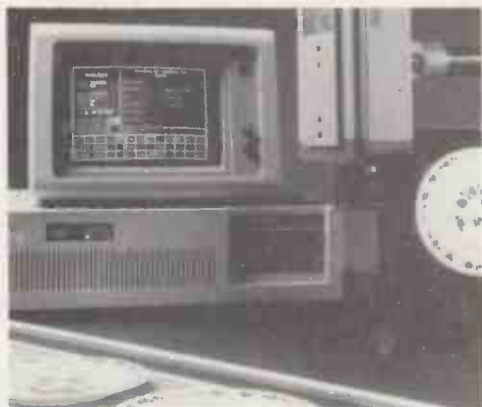

MICROSIGHT RT

A real time image capture system for use with IBM PC/XT/AT with capture of 512 x 512 resolution images at frame rate. Complete with camera and software **£1,490 + VAT**

MicroScale image processing and measurement software available with MicroSight products.

For Further details contact:-

DIGITHURST

The image analysis people

Digithurst Ltd.

Church Lane, Royston, Herts SG8 9LG

Tel (0763) 42955 Telex 818451 DHURST G

→ circle 125 on enquiry card ←

PROTECT YOUR KEYBOARDS



Prevents damage from dirt & spills

VIZIFLEX SEELS

made of Ultrafilm an ultra-thin,
ultra-clear,
ultra-strong plastic

Offering a comprehensive range of seals to
fit most keyboards

TRANSPARENT KEYBOARD PROTECTION FOR

- Computers
- Telephones
- Point of Sales
- Machine Tools
- Pushbuttons
- Circuit Breakers
- Cash Registers
- Control Panels
- Terminals
- Instrumentation
- Rocker Switches

CERATECH Electronics Limited

● LOW TOOLING COSTS
FOR CUSTOM ORDERS

LENTEN HOUSE, 20 LENTEN STREET, ALTON, HANTS. GU34 1HG
Tel 0420 88674 85470 Telex 858509

→ circle 126 on enquiry card ←

TASTM Modifiable Accounting

TAS Plus Database from only £99

TAS Modifiable Accounting was written in TAS Plus, the high speed, 4th generation database and application developer. It combines the power of a relational database with a runtime compiler that produces lightning fast code and outperforms any database we know of. Just look at what you get:

- Relational Database
- Screen Painter
- Program Generator
- Report Generator
- Database Browser
- Source Code Editor
- 4th Generation Language
- Runtime Compiler

Three versions are available. TAS Plus which costs £99. TAS Plus Developer's Version at £199 (this is the one that is included in the price of Modifiable Accounting) and TAS Plus Multi-User Developer's Version at £349 for NETBIOS compatible networks.

A version with a different specification is also available for Concurrent CP/M at £349.

Modifiable Accounting £499

Nominal Ledger

3 years totals by month. Budgeting by month. Multiple departments/profit centres. Up to 10 Rates of VAT. Post to previous periods and reclose. Financial statement writer. Up to 5 bank accounts. Detailed history files.

Purchase Ledger

Easy to enter invoices. Recall last nominal distribution. Pay invoices automatically or by hand. On-line account enquiry. Full supplier history and ageing reports. Real time updates.

Sales Ledger

Invoicing and sales analysis. Easy adjustment of current ledger entries. Statements, aged debt reports, bad debt letters, daybooks etc. Define individual customer history.

Advanced Accounting £799

In addition to Modifiable Accounting you get three more modules:

Stock Control

Wholesale distribution-type. Regular and non-stock items. Average and last cost. Multiple selling prices. Easy stock adjustments. Month and year to date sales and cost. Post to individual nominal accounts. Full reporting.

Purchase Order Processing

Provides for regular and non-stock items. Automatic last cost check. Easy adjustments. Allows for part delivery, over/under shipment.

Sales Order Processing

No limit sales order entry with invoicing and backorders. Full salesman support. Unique price matrix "remembers" specials per individual customer. Picking slips. Easy adjustments and much much more.

TAS-Modifiable Accounting

This comprehensive and fully integrated accounting system consists of Nominal, Sales and Purchase Ledger. No big news you would say. Well, what's unique about it is that it is written in TAS. The high speed multiuser database and application developer that's taking the world by storm. But there is more... Besides the database you also get the source code (that's the original database code the accounting modules were written in) and all other information and tools, including an excellent tutorial and reference manual. This allows you or your supplier to add modules or make changes to existing modules that will become your 100% solution.

Flexible

If you don't like a report you can change it. If you want to combine two reports into one you can change it. If you want a different customer account format you can change it. Never will you have to hear "we can't do that because we do not have the source code".

Expandable

With TAS Accounts you do not have to stand still. Once you have used the accounting system for a few months you may find that you require extra facilities or reports or functions that are specific to your business. Since you get both the database and the source code of the modules included in the package, you can add your own, or have them added for you by one of a growing band of dealers that use TAS accounts as a back-end for their own vertical market software.

Secure

You no longer have to be dependent on the support of a single supplier or on the originator of the accounting package. We know of many computer users that would like to change suppliers if only they could. Or worse, many suppliers have disappeared over the years. Because you have everything you could possibly need to modify and maintain your accounting system it is a secure supplier independent solution.

Cost Effective

For what others charge for a single module you get both the database/application developer and the three integrated accounting modules consisting of Sales Ledger with Invoicing. Purchase Ledger and Nominal Ledger with Report Writer. TAS modifiable accounts offers everything needed by most businesses. It is fully menu driven and designed to be used by everyday business people.

Multi-User

The accounting modules have been written to operate in a multi-user environment. So you can upgrade anytime to multi-user TAS and your Modifiable Accounting is all set up and ready to go with full file and record locking.

What the Press say about the TAS Plus Database:

"Combination of good, basic menu driven facilities with powerful programming tools make it excellent value for money, especially for novices wanting to learn, and developers wanting economical runtimes systems". (Personal Computer World)

"On a value for money basis, this must be one of the most attractive databases on the market". (Accountancy Magazine)

"TAS manages to pack plenty of power into its small price. It performed well in our tests and you can quickly write dense and efficient code for custom applications". (PC Magazine)

"There is no doubting that TAS is a very capable product—it handles serious-sized applications and does so with speed." (What Micro Magazine)

System Requirements

TAS Modifiable and Advanced Accounting runs on any IBM XT, AT and true compatible with a hard disk and at least 384KB RAM. A version for Concurrent CP/M is also available with a different specification.

Money Back Guarantee

The package you receive contains a sealed and an unsealed set of floppy disks that is fully operational but can only save a limited number of records. This allows you to evaluate the complete working system at your leisure. Provided the sealed set remains unopened and all goods are in a good condition and returned to us within 30 days, we will refund your purchase price less handling and a 10% re-stocking charge.

Act Now!

Order Your Copy Today or send or phone for more information to find out how TAS can be your 100% accounting solution.

TAS

Please send me the following items:

More information.

TAS Plus @ £99:

TAS Plus Developer @ £199:

TAS Plus Modifiable Accounts @ £499:

TAS Plus Advanced Accounting @ £799:

Add handling & shipping @ £6:

Add 15% VAT

I enclose a total of:

Payment

Cheque Access Visa

Card Number:

Card Expiry Date:

Card Name:

Card Address:

Postcode:

Daytime Tel. No.:

Signature:

A VAT Invoice will be included in the parcel. Enclose a company letterhead if Invoice name and address need to be different from card name and address.

MEGATECH
CORPORATION

111-113 Wandsworth High Street
London SW18 4HY
Telephone: 01-874 6511. Telex: 21768

When fire hit a computer room at the Open University in Milton Keynes in March it was estimated that the cost of the damage would be near £500,000. Not all computer disasters are as dramatic or as costly as this, but damage to any system can prove expensive — not only in replacing kit but also in reinstating data and carrying on business as usual.

Yet it is estimated that over 50 percent of U.K. organisations have no contingency plans to fall back on should their systems fail. And according to American market research, 80 percent of companies which have suffered a computer disaster go bankrupt within 18 months, and 93 percent of them go out of business within five years.

How a disaster affects you depends largely on what you are using for kit for and on how you deal with it. You may not be able to prevent something happening, but you may be able to minimise its effects.

A disaster can take many forms. Even when an office has fire protection built-in, a system could be vulnerable to fires originating from floors above or below or from neighbouring premises; the Open University blaze was probably caused by a faulty heater on the outside of the building. A fire could even be the result of an arson attack — say, by a disgruntled employee. Water from leaking piped water systems, burst radiators or even a tap which has been left running could cause damage. The failure of an air-conditioning system could cause a computer

to overheat and malfunction. Lightning could cause a power surge. Power cuts or power fluctuations could lose or corrupt essential files which have not been stored. Your hardware or network might fail.

Such things do happen. Business Information Systems' Disaster Casebook estimates that 48 percent of disasters at computer installations are the result of fires and explosion, 17 percent are caused by lightning and power failure, 14 percent by water-related incidents, eight percent by building defects, while the remaining 13 percent is accounted for by other causes.

If your micro also serves as a mainframe terminal your company may well have a contract with a recovery service. Companies like Computer Disaster Recovery, Alkemi, Allen

SURVIVAL GUIDE

An accident to your computer system could be a catastrophe for your business. **Carol Hammond** explores the ways you can minimise its effects.

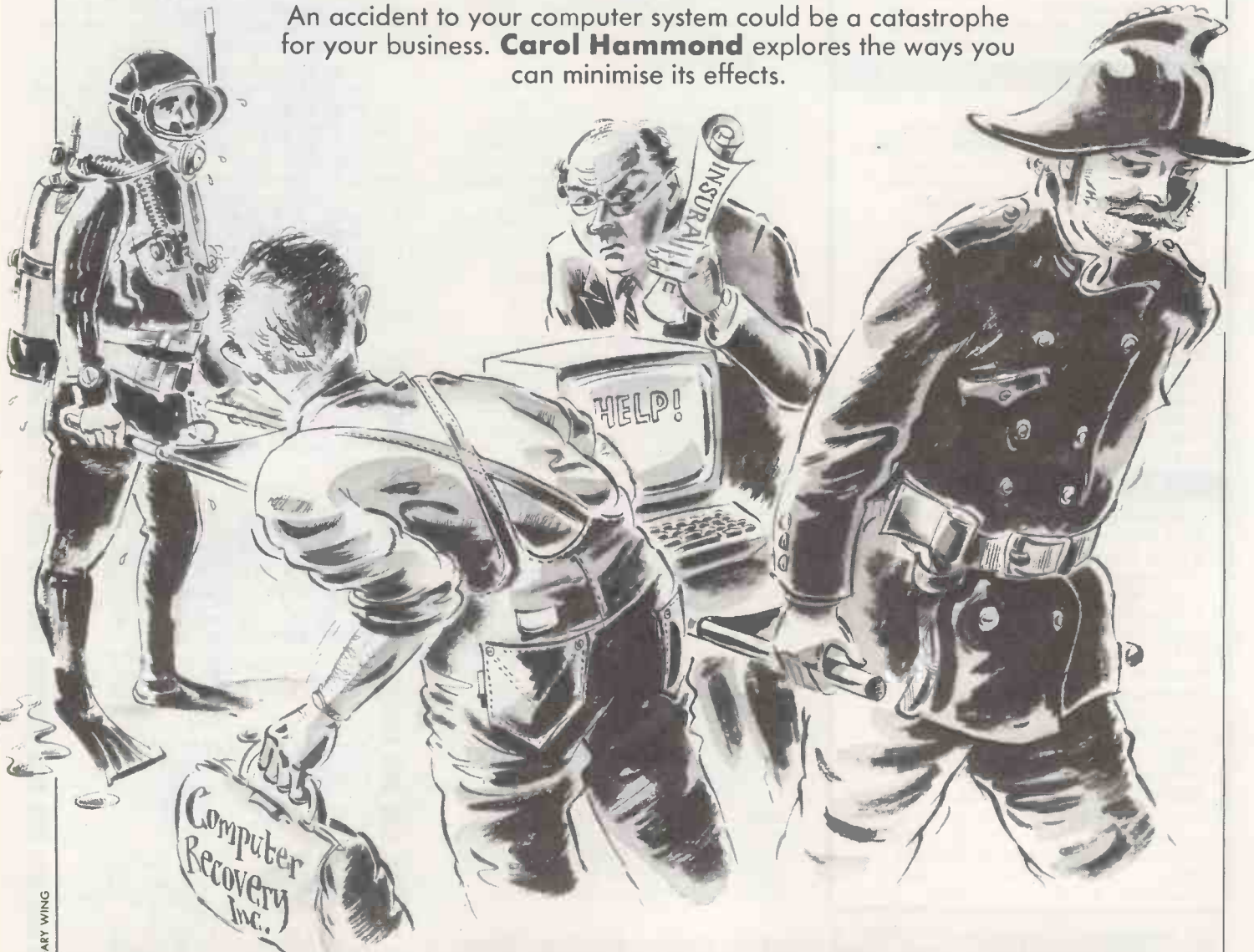

Computers and Failsafe are primarily for minicomputer and mainframe users, as it usually takes them longer to get a replacement machine in the event of a disaster.

Such companies will provide standby facilities in the form of a backup machine. Backups can either come as mobile units or be made available at a site which is shared with a number of other companies. The assumption is that they will not all suffer a disaster at the same time. Standard standby contracts usually provide for backup equipment to remain on-site for a fixed period, after which a daily charge is made.

If a disaster does strike, a recovery service attempts to ensure that a client's systems can be implemented on the backup hardware as quickly as possible. Copies of the client's operating systems, applications software and live data are to hand, and staff will attempt to recover programs and files. The recovery systems supplied are reviewed regularly to make sure they match developments in the client's systems. The recovery service is usually available 24 hours a day. It may also provide alternative facilities for staff where offices have become unusable.

Another way you can prepare yourself against a disaster is to take out insurance. Many insurance companies have moved into insuring computers in response to the rapidly increasing demand for this type of service, and some employ a computer insurance specialist. The type of cover you get varies. The simplest approach is to match a standard policy to your requirements. Alternatively you might want a tailor-made option; this requires a visit from the insurer to assess the risks and your requirements.

Your micro may well be covered by a company-wide insurance policy which takes into account the cost of the hardware, ancillary equipment, loss or damage to media, the cost of recompiling data and the increased cost of working while the system is being reinstated. If there are similar machines available elsewhere in the company the increased cost of working may be small; this is particularly likely to be the case with micros. If you have a maintenance contract this may well cover breakdowns too.

If you do have to take out a policy especially to cover the risk of system failure, different companies offer different kinds of policies. For example, National Vulcan offers a commercial computer policy; General Accident's engineering division, Scottish Boiler and General, offers a micro/mini computer insurance policy; while Norwich Union will cover micros

GETTING HELP

Alkemi Kingswick House, Sunninghill, Berkshire SL5 7BJ. Telephone: (0990) 23491

Allen Computers Allen House, 40-48 Bernard Street, London WC1N 1LE. Telephone: 01-278 4595

BIS Applied Systems 20 Upper Ground, London SE1 9PN. Telephone: 01-633 0866

Computer Disaster Recovery 1 Norley Trading Centre, Valepits Road, Garretts Green, Birmingham B33 0TD. Telephone: 021-784 7445

Failsafe (Istel Ltd) PO Box 5, Grosvenor House, Prospect Hill, Redditch, Worcester B97 4DQ. Telephone: (0527) 64274

General Accident Fire and Life Assurance Corporation Pitheavlis, Perth PH2 0NH. Telephone: (0738) 21202

National Vulcan Engineering Insurance Group St. Mary's Parsonage, Manchester M60 9AP. Telephone: 061-834 8124

Norwich Union Insurance PO Box 48, 1 St. Stephen's Street, Norwich NR1 3TA. Telephone: (0603) 682730

S&S Enterprises 31 Holloway Lane, Chesham Bois, Amersham, Buckinghamshire HP6 6DJ. Telephone: (02403) 4201/28095

under an all-risks extension to a standard business policy.

The type of details you will be expected to supply are the make, serial number and age of your computer, how much it would cost to replace new, the value of media unused, the cost of reinstating programs and other stored information, and the increased cost of working over a set period. It is worth checking what exactly is covered. You may have stuffed your PC with sophisticated expansion boards and have attached it to a costly printer; these items should obviously be protected too.

Policies usually cover three different areas: damage to the computer itself, the increased cost of working, and reinstatement of data. Replacing a micro itself is not usually a problem, but reinstating data — if it is possible at all — can be time consuming and expensive. Information not only has to be rekeyed; it might also have to be gathered all over again. Both activities are laborious, and the effect on your business of losing data even for a few days could be damaging, so you may want to make sure you are insured for consequential loss too.

You should check to see if you will be insured against accidental or malicious erasure of stored information, damage through power-supply failure, the cost of modifying equipment or replacement of records due to incompatibility of computer records, and how much money you will be allowed for computer rental if that is needed.

If you carry a portable micro around with you you may well have thought to insure it outside the office, but if you carry discs around you might not. Even if you have

made backups you may have left those in the office, say, while yours disappear inside a lost suitcase on a trip abroad, wasting time and money. And remember that while reinstating data such as a mailing list is a tangible proposition, reinstating ideas is not and it is unlikely your policy would cover such an event.

It is also worth reading the small print in any agreement for exclusions and stipulations. Some companies may not recompense you for data lost due to the presence of a magnetic field, and that could be caused by something as mundane as a telephone. You may be expected to service equipment regularly, allow only trained and authorised users access to the system, name the individual who has erased any data, take weekly backups, store a duplicate set of discs in a fire-resistant safe, and so on. Some insurers offer lower premiums if a company has a disaster recovery policy.

If you have corrupted data held on disc it is sometimes possible to retrieve it using one of the many utility packages designed for the purpose, or by taking your system to a data-recovery service like S&S Enterprises. Dr Alan Solomon of S&S handles many cases where data has been lost as a result of hardware failure, and many more where carelessness and what he calls "the unforgiving nature of DOS" are to blame.

He cites the most common problems S&S gets as formatting hard discs and wiping out an entire subdirectory. Runners up are the situations where a data file suddenly has zero bytes, where DOS overwrites garbage on the boot sector, the directory and the file-allocation table, and finally when a database file or spreadsheet gets slightly corrupted. He also mentions some programs as culprits for corrupting hard discs and directories.

S&S uses hardware to get data off hard discs and relies heavily on the expertise and experience of its own staff. Various data-recovery programs are used for particular problems, and new ones may be written if a fresh problem arises. Solving problems like this does not come cheap, but it is still likely to be less expensive than retyping a mailing list or reconstructing a complex series of spreadsheets.

Some problems you can try to solve yourself using utilities like S&S's own Undelete to undelete a file, and Unformat to recover data from a hard disc. The Norton Utilities set includes several programs that are invaluable for recovering data that would otherwise be lost for good. Its Unerase routine, for example, will usually restore an erase file and is very easy to use.

Above all, prevention is better than cure. One way of avoiding a disaster is to take frequent backups and to ensure that they are never left in the same place as the originals. Take discs home with you if necessary. If you have just lost the software, then the company you bought it from may well replace it at a minimal cost. After all, in other contexts software houses are at pains to emphasise that you have not bought the discs but the right to use the software on them.

Replacing a micro itself is not usually a problem, but reinstating data can be time consuming and expensive. Information not only has to be rekeyed but gathered once again.



PROBLEM? How do you transfer your valuable data files between PC's of a different type and/or drive size?

SOLUTION! PLUS-FD: A family of 3", 3.5" or 5.25" external floppy drives that make transfer of files between PC's as simple as inserting a floppy diskette!

IMAGINE ★ A 5.25" IBM drive on your APRICOT or VICTOR 9000 ★ A 3.5" APRICOT drive on your IBM PC or compatible.

PLUS-FD



PLUS-FD is supplied cased, with power supply, driver and formatting software. Prices from:.....£299.00

PC UPGRADES



YOUR PC

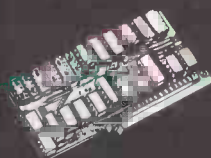

RAM BOARD



INTEGRAL HARD DISC



PLUS CARD

FOR THE IBM PC/AT & COMPATIBLES:
PlusCard - 20Mb and 30Mb Plug-In Hard Disc. A 3.5" hard disc on a card that is simply installed in your PC expansion slot. Integral Hard Disc - 5.25" hard disc in 10Mb to 150Mb. Prices from £395.00

FOR THE APRICOT RANGE:
3.5" 20Mb Internal Fixed Disc. Prices from £595.00

Single-board RAM running at full processor speed.
256k £115
512k £130

MASS STORAGE SUB SYSTEMS

FIXED DISCS: Our external Fixed Discs are available in a range of capacities from 10Mb to 260Mb.
REMOVABLE HARD DISC CARTRIDGE: Solve your data integrity problems by locking your hard disc away at night. Available in 10Mb or 20Mb options, the removable hard disc cartridge uses the same technology as the fixed disc and can be used both as fast back-up and additional on-line storage.
TAPE STREAMERS: Capacities up to 45Mb. Our high speed tape drives will back-up 10Mb in only two minutes.
COMBINATIONS: Fixed Disc units are available in a combination unit, either with a removable hard disc cartridge or tape streamer.
PRICES FROM: £850.00



PlusNet

POWERFUL: PlusNet enables up to 7 PC's of the same or differing types to access/share the data on the same hard disc subsystem.
SIMPLE: For existing Users of a PLUS 5 subsystem, upgrading to PlusNet could not be easier. PlusNet supports single-user software and no additional memory is necessary.
COMPATIBLE: PlusNet supports most PC's running under MS DOS.
PRICE PER MACHINE:..... £350.00
All PLUS 5 Products are covered by a 12 month parts and labour warranty. Optional ON-SITE MAINTENANCE from PLUS 5 is available. (Prices on application). Prices are subject to VAT.

Available from:

PLUS 5 ENGINEERING LIMITED

Crowborough Hill, Crowborough, Sussex TN6 2EG. Tel: (08926) 63211/Telex 95538 PLUS G



Mail and Telephone Orders welcome.

→ circle 128 on enquiry card ←

WHOLESALE CHANGES

At first sight, distributors have no obvious function except to cream off some profit between the manufacturer and dealer. But **Steve Malone** discovered that they have a useful niche in the unstable world of software selling.

In its journey from software house to end-user a program disc passes through many hands. From the user's point of view, one of the least known and apparently unnecessary links in the chain is the distributor. The distributors buy software in bulk direct from the software houses and sell the programs on to dealers, who in turn sell the product to the end-user.

In Britain just three distributors cover the great majority of products sold. The companies are P&P Micro, now the oldest of the large U.K. distributors still in business, along with First Software and the U.S.-based Softsel.

To the cynical and price-conscious end-user, the distributor might appear to be a superfluous link in the chain. After all, why could the dealer not buy direct and pass the savings on to the customer? Leaving aside the naivety which assumes that cost savings will necessarily be passed on, this view has been firmly knocked on the head by a recent attempt to bypass dealers altogether.

A few years ago manufacturers came up with a wheeze to sell direct to many of the large corporations and other big software consumers. But as well as having to set up large and expensive sales and marketing departments, the manufacturers found themselves dealing with a flood of enquiries from customers requiring technical support. They also succeeded in angering the distributor and dealer networks.

John Weatherhead, the managing director of First Software, told us: "About 18 months or even two years ago there seemed to be a change in attitude by the big manufacturers. At that time the future of distributors looked fairly bleak. But in the last year, there has been an increasing realisation by manufacturers of the role of the distributor.

"An established company would like to look after the top 100 accounts itself. But there are many thousands of small companies that need looking after as well, and that is where we come in. Also, if you are a little software house we give you access to the dealer market, and give you help to get to places that you wouldn't otherwise."

Distributors provide the small dealers with some of the benefits of economies of scale. They buy in quantities of a product which a single dealer cannot afford to stock and can therefore command big discounts.

Some of these savings can be passed on to the dealers, who in turn achieve a bigger margin than they would otherwise.

As well as providing the first layer of the pyramid that hands the product down from the manufacturer to the end-user, the distributor performs another vital service for the dealer. Few dealerships, even the largest ones, can afford either the money or the staff to scour the world for new products, particularly as many of them originate in America. On the other hand, if you are a large distributor people will often come to you.

Kevin Hawkins, the technical director of P&P Micro, outlined a typical story. "We are the existing distributor for most manufacturers. Any products that they develop will come to us naturally. We go round all the shows, particularly those in the U.S., and look for new products. We also talk with our customer base about the kind of pro-

ducts they are looking for, and then we actively look for them. We do this by contacting our existing manufacturers to ask if they have got such and such a product in the pipeline, and maybe we suggest something. We also read the technical press for any new products that might emerge." P&P has permanent contacts in the U.S. who have access to the software houses where most new products emerge.

Softsel has an even greater advantage. As the biggest distributor in the U.S., the company is able to deploy more people in the field to look for new products. Furthermore, many of the smaller software houses will automatically approach Softsel as distributor, rather than other British companies.

John Weatherhead, however, relies mostly on his own contacts to get hold of new products for First Software. "I know a lot of people in the industry," he told us. "Not just in the PC side but in electronics and semiconductors as well. We have gained many of our lines on a personal level, including companies such as Hercules and Intel. We don't have any staff in the U.S. We've talked about it but there aren't that many super-duper new products out there to justify it."

Although their bread and butter comes from a network of dealer accounts, some distributors also deal directly with end-users, especially the large corporate software users. P&P Micro adopts this approach and has its own corporate accounts force (CAF) to do the job. The CAF will not only negotiate discounts, but also acts as a kind of consultancy. This service does not extend to writing customised software, but the CAF does take part in the customers' strategic decision making. For example, P&P might use its insight into the industry to advise a company to invest in one local area network rather than another.

The situation is complicated further by the fact that some very large companies hold their own dealerships. ICI, for example, has a wholly owned division called Agvisor, which is a fully fledged IBM dealer. It was set up within ICI to deal with the computing needs of the corporation and to resell products within the group. Thus for a distributor dealing with Agvisor, the relationship is not one of distributor and customer but more the standard distributor/dealer one.

Not all distributors have the kind of

(continued on next page)



There are many small companies that need looking after, and that is where we come in. Also, if you are a little software house we give you access to the dealer market.

JOHN WEATHERHEAD, FIRST SOFTWARE

(continued from previous page)

direct-selling operation used by P&P. The principal reason for this is that the distributors do not wish to antagonise their dealers. Everyone we spoke to at P&P was quick to emphasise the company's commitment to its dealers. David Southworth, the managing director, said: "P&P is a distributor as far as we are concerned. Most of our effort goes into supporting our dealers. We have both hardware and software products that we have built up over a number of years, and can offer dealers a complete solution."

Softsel, on the other hand, will sell only to dealers. Peter Scatchard, Softsel's marketing manager, explained why it takes the position: "We have no direct corporate selling force, and it is not our policy to do so. We don't see how that is a viable policy. I'm amazed that dealers deal with people who do that sort of thing, as it is taking the bread out of their mouths."

Although distributors provide many valuable services to their dealers, with a wide-ranging choice of applications and utilities, they still have to go out and sell their products. Over the years, the distribution companies have developed a whole battery of methods of doing this.

Peter Scatchard enumerated the approaches taken by Softsel, while stressing that there is no common pattern to the way it approaches its dealers. "We use the full range of marketing devices to create awareness of a product. We have a weekly newsletter which goes out to the dealers, we advertise in the trade press, we use telesales and we have field sales staff. We also



We have no direct corporate selling force. I'm amazed that dealers deal with people who do that sort of thing, as it is taking the bread out of their mouths.

PETER SCATCHARD, SOFTSEL

organise the Soft-Teach seminars, which bring people up to date with the latest products."

Between the dealer and the distributor a new kind of company is emerging, perhaps best described as a corporate value added reseller. In the United States the largest company of its kind is Corporate Software Inc., and a year ago it set up a U.K. subsidiary known as International Software.

David Skok, the managing director of International Software, explained how the company operates. "We are not strictly a distributor or a dealer but we are something completely different. We deal directly with the information centres within companies. We have spent a hell of a lot of time researching into these information centres."

The information centres that Skok refers to are departments within a corporation dedicated to dealing with end-user problems and training. Often the information centres will be the data-processing department, although this is by no means exclusively the case.

David Skok continued: "Most dealers treat these centres as just another end-user, and only provide a first level of support — how to move a column of figures in a spread-

sheet, for example. We provide a second tier of support, dealing with more complicated questions.

"Most information centres are busy on the telephone doing hotline support. Our figures have shown that corporate numbers have grown from 80 PCs per site to something like 700, while at the same time the number of technical support people at an information centre has grown from two to four. When they come across a complex problem they throw it straight at us. We manage to solve 95 percent of problems the same day."

International Software receives its products both from distributors and directly from the manufacturers. Skok says that his company benefits from its established reputation. "We are usually approached by a manufacturer, and they will demonstrate the product to us. We look for products that are unique and meet a need in the corporate marketplace. We don't want to sell just another spreadsheet, as most companies have already decided to standardise around Lotus 1-2-3."

One of the major problems confronting the entire retail side of the computer industry has been the shakeup in the micro-computer dealer network. Many of the High Street names which arose with the first great boom in business micros have now gone into liquidation. But distributors continue to take a relaxed attitude. Peter Scatchard's comments reflect the mood. "There are a greater number of outlets where you can buy computer products than ever before. There are fewer of the traditional dealers but there is now a different sort of dealer. The corporate dealer, consultancies and High Street retailers are all doing very well, and we will deal with anyone who wishes to sell computer products."



Most of our effort goes into supporting our dealers. We have both hardware and software products that we have built up over the years, and can offer a complete solution.

DAVID SOUTHWORTH, P&P

64 reasons why you should get your hands on a SigNet 4.

The hands of 32 people using word processing, spreadsheets and data bases, all at the same time, are 64 very good reasons for taking a good hard look at the SigNet 4. Truly a multi-user, multi-processor computer of the highest calibre.

Networking PC's can be a complex and expensive business. Hence the new breed of 'plug and go' 4 user systems which seem to offer the instant solution.

Maybe, but what of the long term? What if your company's future needs are for a 5, 12, or 24 user system?

It's precisely because a company that's growing needs to have all its options open, that SigNet 4 is designed to be a perfectly flexible solution and at under £1,000 per user it's cost effective too.

As your needs grow just add another board which allows you to run 4 more users. The basic computer includes all the structure and operating systems needed for up to 32 users, as and when you're ready.

With SigNet 4's modular approach you can have your system built to order in just 30 minutes with the hard disc capacity and tape back-up requirements tailored to your needs.

Because each expansion board is a computer in its own right, adding extra users doesn't slow existing ones down. Applications demanding large amounts of memory can have up to 4 Mbytes of RAM for each user if required. Furthermore, almost any application your company has can be met by SigNet 4 because it uses Digital Research's Concurrent DOS which means that you have access to an enormous range of industry standard software.

Data Dynamics, who designed and manufacture SigNet 4, have been building computers since 1966, (indeed our SigNet 3 system earned itself the title of "Britain's most used multi-user micro"). So experience is our strength.

No-one recognises the importance of back-up facilities more than we do. Which is why we have our own field service company with depots and engineers throughout the country.

Send back the coupon and we'll send you a brochure, or better still, ask us to give you a demonstration in your own office.

If you are a company with an eye to controlling your own future and finances you'll find there are *at least* 64 reasons why you should get your hands on a SigNet 4.

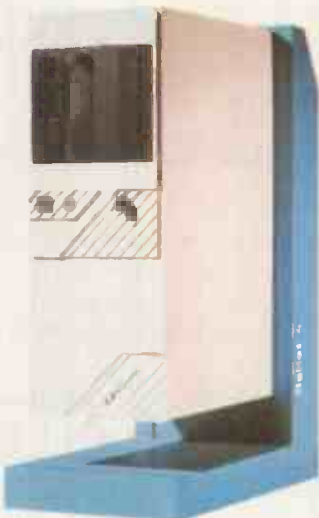

SigNet 4

data dynamics

- Please send me full details of the SigNet 4 System
- Please call me to arrange a demonstration of the SigNet 4 System

NAME _____

POSITION _____

COMPANY _____

ADDRESS _____

POSTCODE _____

TELEPHONE _____ EXTN. _____

DATA DYNAMICS LTD.,
Clayton Road, Hayes, Middx.
UB3 1BD

ORCHID'S JET 386: POWER FOR THE FUTURE NOW



Jet 386 is the Ultimate Accelerator Upgrade for your AT

Announcing an end to obsolescence. Orchid's Jet 386 accelerator card extends the life of your computer investment into the 1990s, by incorporating the very latest PC technology; the 80386 processor.

Three Times Faster than an AT

Unequalled compatibility with ALL your existing PC applications AND provision for future 386 software and operating systems; the Jet 386 accelerates spreadsheets, CAD, networking . . . by up to three times. To ensure 100% compatibility, there's even a toggle switch between 286 and 386 modes.

→ circle 142 on enquiry card ←

Easy Installation

Simply plug the Jet 386 board into your system. There's no special software, no new commands; Jet 386 boosts your AT up to three times its normal speed. Orchid's Jet 386 provides the most cost-effective performance upgrade for your AT.

From the People Who Started it all

Orchid combines 80386 power with XT Turbo Technology perfected in the critically acclaimed TinyTurbo 286. Like the whole Orchid Turbo family, the Jet 386 is built for lasting value.

Contact Orchid for information on the Jet 386, and the full range of Turbo products. Or call an Orchid distributor for your local dealer:

First Software 0256 463344
LanCom International 0993 76543
Softsel Computer Products 01-568 8866

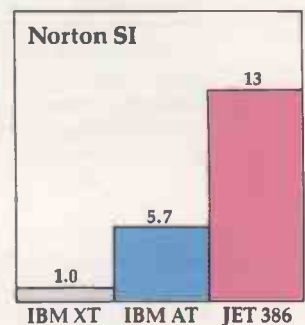

ORCHID
The Innovative Leaders
Orchid (Europe) Ltd.
Unit 9A, Intec 2, Wade Road,
Basingstoke, Hants. RG24 0NE
Tel 0256 479898 Tlx 946240 ref 19023380

IBM'S NEW STANDARD

IBM has finally done it: on 2 April it launched the Personal System/2, its successor to the PC. After more than a year of industry speculation about the form the business computing standard for the 1990s would take, IBM has confounded many predictions: it has not followed a



totally closed proprietary route, nor has it chosen to meet the clone challenge head on. Instead it has

produced what has all the indications of being a far more coherent and longer-term strategy which embraces its complete range of products, including minis and mainframes. Along the way it has put together the fastest micro around, reinforced the Token Ring

network standard and given its official blessing to Worm optical storage discs. Perhaps the most surprising aspect of the new machines is the fact that IBM seems to have got so much right.

The details are spelt out by Steve Malone on page 87, including a full explanation of the new

standards and benchtests of all

the machines. On page 93

Ian Stobie discusses OS/2,

the powerful new operating

system written by Microsoft.

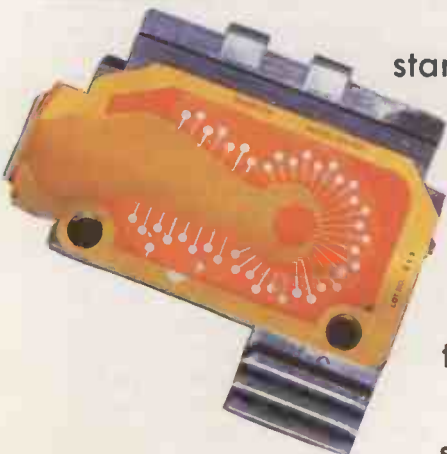
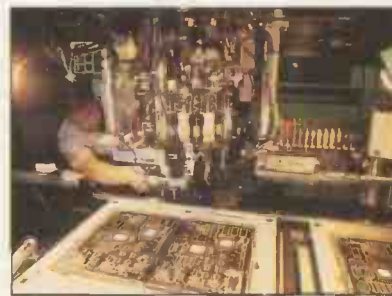

(continued from previous page)

The contrast between the two generations of IBM micros could hardly be greater. The IBM PC seemed almost thrown together by a maverick IBM division, working despite rather than with the rest of the organisation of which it was nominally a part. The Personal System/2 clearly represents not just a product but also an overall strategy for the whole company. Even the name betrays this.

Before the launch, people routinely referred to the coming IBM machine as the PC 2. The shift to PS/2 — from "computer" to "system" — is a clear indication that these new micros belong to the world of IBM's other machines like System/36 and System/38 minis, and the System/370 mainframes. They are to be thought of as part of a family of integrated products designed to offer complete solutions to a company's computing needs. The recently announced Systems Application Architecture (SAA) is the glue which binds these different systems together.

SAA is discussed in greater detail on page 96. Basically, it offers users the possibility of transferring programs and data across the whole range of IBM products — something which has hitherto been impossible. This addresses a great weakness of the IBM range compared with the DEC family of products. The contrast had become particularly unflattering to IBM in the light of the announcement of the DEC Microvax 2000 — reviewed on page 42 of this issue — which provides a bottom-end system complementing the rest of the Vax range. DEC now offers machines from desk-top to mainframe, all capable of running the same program, something which is a powerful selling point for companies looking to develop their computing facilities while retaining compatibility.

The buzz word for this integrated approach is "connectivity". The linking up of the Personal System/2 to mainframes has been made easier by extra features in the operating system. Significantly, IBM's advertisements for the Personal System/2 pick up this concept

We are underwhelmed — and flattered — by these announcements. After all the speculation about proprietary architectures and radical changes in technology there is nothing in these announcements that presents a real challenge to us as the major compatible manufacturer.

OLIVETTI

and explicitly introduce the word "connectivity"; they also emphasise that many of the ideas built into the new micros come direct from the world of mainframes.

In effect, the functional connectivity now offered by IBM will be matched by an organisational one. In the process, the original concept of an independent, truly personal computer will be blurred; instead, as far as the user is concerned, the ambiguously named Personal System/2 will become an element of the corporate computing solution. In this respect, it is no coincidence that the top-end models no longer sit on the desk but skulk under it.

Advertisements for the new machines highlight another key strategic element. For the first time, IBM has acknowledged the existence of the clones, claiming "Only the past can be cloned. The future must be created." This is a clear signal that the new range is designed in part as a response to the enormous loss of market share which IBM has suffered at the hands of the assorted compatibles.

But IBM has been subtle about it — so subtle, in fact, that many people, clone manufacturers included, have been foolishly dismissive about the ease with which the Personal System/2 will be mimicked. In part this is because OS/2 — which will be available to any manufacturer — is purposely designed to allow software houses to ignore hardware details completely. The old ROM BIOS, which formed the core of

cloners' efforts on the PC, can be dispensed with entirely, leaving nothing to copy.

Instead, IBM has chosen to use hardware as its defence against the cloners. For example, the PS/2 machines contain a number of advanced custom chips. Whereas the PC was notorious for being knocked together from standard components which anyone could — and later did — lay their hands on, the Personal System/2 will require a lot more research from potential compatible manufacturers. They could use discrete components to reproduce the behaviour of the new IBM chips, but in doing so they would lose any cost advantage they may have hoped to offer over the IBM.

The effect of the other semi-proprietary element is even harder to evaluate. It is the Micro Channel, which is described in detail on page 90. IBM has been very vocal in emphasising its proprietary nature while stressing that it will remain open in terms of published specifications. Quite how it is proprietary is unclear — even to the IBM U.K.'s technical experts, apparently.

It is hard to see how even IBM could hope to patent things like voltage levels or the size of pins. Yet against this there are the words of IBM U.K.'s Chief Executive Tony Cleaver: "Given the widespread copying of our products you would also expect us to act to protect our own investment — and you would not be disappointed." The success or otherwise of the cloners may well hinge on the precise nature of the proprietary elements in the Micro Channel, and the ease with which its functions can be duplicated by other means.

Perhaps the biggest question mark hanging over the Personal System/2 is how soon — if at all — it will replace the earlier generation of PCs as far as users are concerned. One school of thought holds that the current standard — of which there are something like 10 million adherents in terms of hardware, including clones — is a mass too large to be budged. According to this view, IBM has lost control of the PC standard, which now belongs to the users; they are hardly likely to ditch billions of pounds of investment in hardware, not to mention time and energy.

On the other hand, it is argued that users will want to move forward; they are sick of the restrictions imposed by DOS, and frustrated by the limitations of hardware. The new software which exploits the multi-tasking power of the 80286 chip, the stunning graphics of the Personal System/2 machines and the other exciting elements of the new systems — they will all be eagerly snapped up by the power-hungry business world.

Of course, both are right. The 10 million users of current PCs are not going to experience overnight conversion. But it seems equally clear that many users will welcome the new power, and particularly the new integrated approach. This

The PS/2 Model 50 (left) is likely to take over the workhorse role currently filled by the PC/AT (below).



suggests a possible pattern for future micro purchasing.

Larger companies who are looking for a complete unified corporate computing policy are almost certain to go for the Personal System/2. It offers them the chance to tidy up all the loose ends which micros have introduced. By sticking with IBM, they can be sure they will not get locked out of future developments. On the other hand, smaller companies who have bought ATs are likely to stick with them for some time. For one thing, they need to write off the cost over several years; for another, their personal computing needs are far more modest. In fact, they have probably barely begun to use the full power even of present-day machines.

And so the world of personal computers will split into two. At the bottom end there will be the huge residue of older machines, faithfully serving their owners year after year. New programs will continue to be written for them, though by the smaller software houses; many of them will be for vertical markets. The manufacturers of add-on boards will flourish in this sector even more than before as they provide all kinds of wonderful upgrades which compensate for the increasingly ancient technology.

For those with good memories, this will sound very familiar: it is a replay of the story of the Apple II. When the IBM and later the Macintosh were introduced, the pacesetters and power users moved on. But the millions of satisfied Apple II users did not disappear. Instead they went on buying new programs and new cards designed to soup up their ageing systems, which continued to serve the purposes for which they were originally bought.

And just as the IBM PC and Macintosh took time to catch on, so the Personal System/2 will experience the same transition period. Initially there will be few boards around because IBM itself has catered for most needs. But as the shortcomings of the machines become evident, so third-party manufacturers will fill the gap.

It will be the same with software. Nobody is going to rush in; instead there will be a gradual coming to market of programs running under OS/2. Indeed, during the transition period, many programs running under Windows and DOS 3.3 will probably appear, preparatory to being moved across to OS/2. Microsoft's forthcoming version of Excel for the IBM is a case in point. First it will run under Windows and then later, presumably, be ported across to OS/2.

Although practically all DOS programs will run under OS/2 they will not run particularly efficiently. Writing from scratch for OS/2 will produce improvements in performance. As a result there is a real chance for a totally unknown software house to break the stranglehold of the main players who currently dominate the DOS world.

Several of the fastest-growing areas in software at the moment are likely to be among those most affected by the appearance of the new systems. For example, the desk-top publishing scene will be transformed by the rise of Windows. Enhanced graphics standards will also be an important factor here, allowing new players to enter the presentation-graphics market. The multi-tasking facilities of OS/2 should greatly broaden the scope of the communications area and make possible exciting developments in the world of integrated packages.

Of course, one of the biggest brakes on the appearance of software, and indeed the acceptance of the Personal System/2 as a whole, is the delay before OS/2 becomes available. It will be released in an early version to software developers in the next few months, but it will not be until 1988 that the full-blown version hits the streets. The 80386 version could well be one or even two years later.

The delay suits IBM perfectly. By introducing uncertainty into the market it throws its competitors into disarray. While the world waits for the next round of products, IBM can continue to sell off the old inventory: it creates a vacuum in the market and then fills it. It is not just the products which appear to be well thought out. This whole strategy of pre-announcing models and thus stealing the opposition's thunder suggests that IBM is in fighting mood and unwilling to settle for second best. Although in the short term the micro industry may well suffer, in the long term it will probably benefit as the market leader begins to attack with advanced technology, not just sheer marketing muscle.

Quite where things will be in one or two years' time is hard to say in the present climate of engineered confusion. For example, it is not clear how the top-end 80386 machine will affect the already poor sales of the lame duck RT/PC or even those of the System/36. Once Unix comes through, the Model 80 must be a strong contender for multi-user departmental applications, and it will be interesting to see how this potential clash has been resolved in IBM's master plan. One thing, though, is certain: the next few years in the world of business micros will be far from dull.

Apricot is committed to the open architectures supported by the industry as a whole. Apricot will incorporate Personal System/2 features into its products in accordance with market demand and support of the software industry.

APRICOT

THE HARDWARE STANDARDS

STEVE MALONE DETAILS THE TECHNICAL FEATURES OF THE PERSONAL SYSTEM/2 FAMILY.

With the launch of the Personal System/2 IBM has come to terms with the advances in technology that have taken place in the years since it launched the PC. It also goes a long way towards recognising that users have moved on as well — not only in the technology that they expect but also in the way they are now using their machines.



SURFACE MOUNT TECHNOLOGY

Central to the new design is the use of surface mount technology for most of the chips. Instead of being connected by the traditional method of mounting chip sockets on the board and then pressing the chips themselves into the holders, the chips are soldered directly on to the board.

This has several major benefits for the design. To begin with, the components can be packed far more tightly. You can therefore get more chips on to a smaller surface area, which means that the final footprint of the machine can be considerably smaller. Secondly, the single biggest cause of failure in computers is not the components themselves but damaged pin connections between the chip, the socket and the printed circuit board. With surface-mount technology the possibility of that kind of fault almost disappears.

Surface-mount technology also lends itself to the automated assembly of circuit boards, and this has long-term implications for the future of high-technology industries in developed economies and for IBM's Greenock plant in particular. Throughout the 1980s there has been an accelerating movement of high-technology manufacturing away from traditional areas such as the U.S. and Europe towards the Far East.

The conventional method for the construction of computers has contained a large and irreducible labour element, so the low wages paid in countries such as Taiwan, South Korea and Singapore have brought considerable benefits. Even Japan has found much of its production moving overseas. But with automated lines assembling surface-mount components IBM expects to be able to undercut Far East production. Obviously this is good news for IBM and its workforce, but it also emphasises the company's determination not to be outpriced again.

PC-SIG LIBRARY

Now over 700 Disks

Only £6 per disk
special introductory offer all disks
£5. Offer ends June 30.

Finally software you don't have to be rich to own

We're ISD, UK's Sole Authorised Distributor for PC-SIG. We offer the world's largest library of public domain and user supported software. (whose authors request a donation from satisfied users) For £6 per disk, you buy software that has been selected from leading authors, thoroughly analysed and professionally supported.

UTILITIES

- 66 GINACO54 polished routines written in basic for any beginner or experts.
- 133 ULTRA-UTILITIES 4.0 recover lost files, modify sectors, etc.
- 245 ULTRA-UTILITIES FILES UNSQUEEZED.
- 405 PC-DESKMATES Better than all of the rest of the memory resident desktop utilities.
- 273 BEST UTILITIES All of the most requested utilities on one disk.
- 478 HARD DISK UTILITIES A collection of the best in the library.
- 414 UNPROTECT Various routines to disconnect protection schemes.
- 376 PATCHES make back up copies of some of the most popular commercial programmes with this collection.
- 507 PC-SPRINT Software and instruction on how to cheaply speed up your system 2-3 times.

EDUCATION

- 403 PC-TUTORIAL A great introduction to DOS.
- 105 PC-PROFESSOR Learn Basic the easy way. One of the best tutorials on BASIC.
- 254 PC-DOS HELP type "help" for the DOS command you forgot.
- 320 TOUCH-TYPE Advanced type tutor.

WORD PROCESSORS

- 78 PC-Write 2.4 a fully featured word processor.
- 415 W-ED LETTERWRITER Word Processor editor. Controls letter processing.
- 480 PC-OUTLINE Outline and organise information, much like Thinktank

DATABASE PROGRAMMES

- 5 PC FILE III most popular database program.
- 398 ESIE EXPERT SYSTEM Artificial intelligence shell to build a custom knowledge base.
- 503 RELIANCE MAILING LIST Keeps track of multiple lists, sorts and prints by specific group - good for custom mailing.

FINANCIAL PROGRAMMES

- 423 PROJECT MANAGEMENT handles over 1,000 tasks with CPM
- 430-431-432 ANALYTICAL DISKS (3) Complete spreadsheet, database, graphics, word processor- fast!

COMMUNICATIONS

- 212-334-621-622 RBBS 14.1 A bulletin board classic. (4 disks)
- 310 QMODEM the fastest communications programs you can buy at any price.
- 499 PROCOMM Communications with XMODEM, KERMIT, ASCII protocols, supports, IBM-3101, DEC VT52/108, ADM-3 and ANSI.

MANY GAMES AVAILABLE
DEALER ENQUIRIES WELCOME

GRAPHICS

- 344-345 PC-KEY DRAW A Colour Graphics system. Lots of demonstration files.
- 418 PC-GRAPH Allows user to create graphics from PC-File report files.

MATHS AND STATISTICS

- 88 EPISTAT 3.0 Statistical analysis of small to medium-sized data samples.
- 654 655 Kwikstat Graphical Orientated programme for graphic statistical analysis.

LANGUAGES

- 148 XLISP 1.4 Lisp language interpreter.
- 417 PROLOG VERSION 1.9 Complete with editor and documentation.
- 409, 410 SNOCREST BASIC two disk set. Real basic interpreter. Can be used with a multi-user system.
- 424 PASCAL COMPILER Written in Turbo Pascal.
- 510 VISIBLE PASCAL COMPILER Learn to programme PASCAL

SPREADSHEETS

- 199 PC-CALC Fabulous 123 work-a-like from the author of PC-File.
- 406 FINANCIAL PROGRAM Lotus worksheet
- 301-303 Lotus financial and budgeting applications (3 disk set)

LATEST ADDITIONS

- 522 INSTANT RECALL memory resident programme that stores and retrieves a wealth of information.
- 523 SIDE WRITER Print your large spreadsheets sideways on the printer.
- 528 NEW YORK WORD The most powerful wordprocessor we have; all the standard features plus automatic indexing, table of contents and foot-noting.
- 568 PC-PROMPT Memory resident helper for DOS command and syntax.
- 576 PC-TICKLE The perfect reminder for appointments and 'thing to do' list.
- 577, 578 C TUTOR Perfect for those wanting to programme in C.
- 579, 580 PASCAL TUTOR Learn to programme in PASCAL in the convenience of your own home.
- 598 DISKTOOL Like Norton's; recover erased files, or fix damaged files.
- 608 AUTOMENU Create professional menus, without all the hassle.
- 611 BLACKBEARD The programmer's editor for writing code in PASCAL, C, or FORTRAN.

QUICK START EVERYTHING FOR THE NEW USER, includes CATALOGUE LISTING OVER 600 DISKS

403 COMPUTER TUTOR 5 PC FILE III
78 PC WRITE 273 BEST UTILITIES
199 PC CALC 476 PATRICK'S BEST
405 DESKTEAM GAMES

£70 VALUE - ONLY £40
10 DISKS - £50

QTY	DESCRIPTION	PRICE	VALUE
	DISKS		
	QUICK START	40.00	
	SHIPPING		2 00
	SUB TOT		
	VAT		
	TOTAL		

PC-SIG
AUTHORIZED
DEALER

ISD INTERNATIONAL
SOFTWARE DISTRIBUTORS Ltd.
P.O. Box 872, Sutton Coldfield,
West Midlands, B75 6UP
Telephone: 021-378 2229

USER GROUP ENQUIRIES
WELCOME
MEMBERSHIP AVAILABLE

0007

→ circle 143 on enquiry card ←

NETWORKS ARE A NIGHTMARE!

Networking Is complicated, expensive and difficult to understand and implement!

This has been the traditional view but now there's EASYNET, the reliable and inexpensive network that keeps computers in touch. EASYNET is different from other, more expensive systems because it works by enhancing the operating system of the PC's you're already using - C/PM, MS DOS or PC DOS. There's no central file server or expensive cable. Installation is as simple as plugging in a phone. With EASYNET, the people in your office can share modems, printers, hard disks and other resources to get the information they need quickly and efficiently.

EASYNET for
£350.00
per station.

Supports C/PM, PC DOS, MS DOS

Shared Resources (Printers, Disk Drives, Modems)

NO Dedicated File or Printer Servers

Flexible print Queue and Spooling

High Speed Communications (1.5Mb.p.s.)

Efficient Bus Topology and Low Cost Twisted Pair Cable

Up to 200 Stations Per Network

User, Group and Global security access

Interstation Messaging

Very easy to Install and Use

EASYNET STARTER KITS ARE
£695 (+VAT)

This includes:
Software, 2 x Plug in Cards, Cabling kit & Documentation

EASYNET

The Low Cost, High performance LAN Solution

Send for further information to:

LOGOTRON

Dales Brewery, Gwydir Street, Cambridge CB1 2LJ. (0223) 323656

→ circle 144 on enquiry card ←

(continued from page 87)



PROPRIETARY CHIPS

Another of the technology advances which has occurred in the past five years is the emergence of the very large scale integration (VLSI) gate arrays. These chips pack the functions of a number of smaller chips into one highly efficient device. Many of IBM's rivals already use this technology.

The introduction of five proprietary IBM VLSI chips across the range is bound to give the clone manufacturers pause for thought. What they would have liked was for IBM to have bought in the VLSIs from a manufacturer like Chips & Technology so that they could have bought identical chips from the same source.

The new chips are the Multi-Colour Graphics Array chip used in the Model 30, the giant Video Graphics Array (VGA) chip in the Models 50, 60 and 80, a direct memory access controller, a processor support chip and a peripheral I/O controller. While it would be rash to say that these chips are unclonable, they are likely to provide a lot more trouble than the discrete components they replace. This probably gives IBM at least a year to 18 months head start on the opposition.

For some reason unknown even to the IBM engineers we spoke to, the company has not used surface mount technology for its BIOS chips, and has used conventional socketed packages instead. The Model 30 has two 32K BIOS ROMs of a kind familiar from the earliest IBM PC. Further up the range the ROMs are renamed the Compatibility BIOS (CBIOS). There are in addition two ROMs, called the Advanced BIOS (ABIOS), that will cope with the extended features of the OS/2 operating system when it appears.

The ABIOS has a security feature designed to prevent unauthorised access to the data and programs stored on disc. A password can be held in battery-backed CMOS RAM, and it is possible to arrange for the machine to require the user to enter the password before it will complete its boot sequence. A security file held on the disc also contains the password, and can be used if the battery fails. The security provided by this facility is far from unbreachable, and it remains to be seen how useful this facility really is.

It is also not yet clear how clonable the ABIOS might be. Given the way in which the original BIOS was reproduced, this aspect of the machine is likely to be the least of the compatible manufacturers' problems.



FLOPPY DISCS

Perhaps the most obvious difference between the PS/2 machines and their predecessors is the use of 3.5in. disc drives. The movement away from 5.25in. floppies has been signalled by IBM for at least two years. The only question was when, not if, the new drives would appear as standard on a mainstream line of machines.

At the moment we are looking at the situation and evaluating its impact. On the development side we are evaluating everything necessary to investigate boards for the PS/2 area. It is too easy to overreact to announcements by IBM, and it would not be true to say that boards like the AST Sixpak are a thing of the past.

AST

The ground was prepared with the launch last year of the Convertible lap portable. When the machine reached the dealers' showrooms the clone manufacturers dutifully fell in behind, and in response to nods and winks from IBM itself the software vendors began to move their software to the new media. Most important programs are now available on 3.5in. disc. For those that are not, IBM is thoughtfully bringing out an external 5.25in. floppy-disc drive for use with the PS/2 machines.

At the top of the range, IBM has gone one better than most people expected. Apart from the Model 30, which has standard 720K floppy drives, all the models in the range are fitted with 1.44Mbyte disc drives. These large-capacity drives can read the 720K format, and IBM says that all its software will be distributed on 720K discs so as to maintain compatibility across the range.



MEMORY CHIPS

Another first for the Personal System/2 is provided by the memory chips fitted to the top machine of the range, the Model 80-111. For this model, IBM has chosen to use page mode aspect dynamic 1Mbit RAM chips identical to those used on its mainframe computers. These chips have an 80 nanosecond access time which, on the face of it, is insufficient to cope with the very high speeds of modern processors. It is by using page mode aspect that the access time is cut.

Page mode aspect is built into the RAM chips themselves. It works by the processor addressing a memory cell in the normal way — that is with a page and offset. Once the address has been identified a 2K stream is released on to the data bus without further addressing being necessary.

IBM says that this method of addressing can cut the access time down to 40ns. The technique works most efficiently when the processor attempts to access 2K blocks, and its advantages will be lost if the processor is constantly leaping around memory. However, as a great many accesses are short loops within a 2K block there is likely to be a sufficient saving to warrant its use.



VIDEO DISPLAYS

It seems that whenever IBM launches a new micro it feels the need to introduce a new graphics standard. This time we got not one but two new graphics standards to go with the four IBM already has on offer.

The top three models in the range are fitted with the Video Graphics Array (VGA) chip, which is capable of supporting most existing formats. Thus the chip can support programs written for the Monochrome Display Adaptor (MDA), the Colour Graphics Adaptor (CGA) and the later Enhanced Graphics Adaptor (EGA). The new format has a new character matrix of nine by 16 pixels. It can support up to 256 colours on screen from a 262,144-colour palette on a 320-by-200 resolution. At its maximum resolution of 640 by 480 pixels the number of colours falls to 16.

These machines will also support the new 8514/A display adaptor card, which fits into a special extended slot provided for it on the Micro Channel. It is intended to replace the Professional Graphics Adaptor as the top-of-the-range display for the PS/2 series. It is fitted with 1Mbyte of RAM as standard and offers a resolution of 16 colours on a 1,024-by-768 resolution, for which it requires a special monitor. It can also display 640-by-480 pixel graphics and 16 colours on a standard enhanced monitor.

The 8514/A card is fitted with its own block-image transfer chip, making use of the same blitter technology that caused such a sensation when it first appeared on the Commodore Amiga. The 8514's graphics are equally stunning, with the ability to move images of near photographic quality quickly and smoothly around the screen.

The board has other features too. It can support a high-speed font cache, which works in a similar fashion to the new range of Hercules graphics cards. Custom fonts can be held in RAM and accessed as though they were held in ROM. This is in contrast with the early CGA format, which had to build characters on each pass of the screen. Up to 256K can be set aside for the font cache.

Instead of the VGA, the Model 30 uses an alternative format known as Multi Colour Graphics Array (MCGA). All applications written to run on the old CGA card will run without alteration on the MCGA. The big advantage is that instead of the eight-by-eight-pixel character matrix which has caused premature myopia in a generation of PC users, the character resolution has been doubled to a more acceptable 16 by eight pixels.

The MCGA has other advantages too. It uses square pixels, and they provide a much better graphics display compared with the older round variety. The Macintosh also uses square pixels, with obvious beneficial results. In order to maintain compatibility with the CGA

Even if the PS/2 range is not remarkably innovative, IBM has recognised that it must now compete on specification, price and performance.

FUTURE COMPUTERS

(continued from previous page)

card, the aspect ratio — that is, the relative proportion of the screen length and width — is preserved.

The MCGA improves on the CGA in two ways: the refresh rate has been doubled to 70kHz, and a non-interlaced refresh has been introduced. Normally, the VDU's electron beams refresh the phosphor in alternate lines, a process that is known as interlacing. This was necessary to maintain the display in the days of slow refresh rates. The trouble is that the guns can easily get out of sync from one pass to the next, and it is this faulty synchronisation which causes the wobble. With the high scanning rate of the new system interlacing is no longer required and the problem disappears.

In graphics mode the MCGA can support a 640-by-480 screen which offers two colours, or two grey shades on a monochrome monitor. At a resolution of 320 by 200 pixels up to 256 colours can be displayed on-screen, or 64 grey shades. The colours can be selected from a palette of 262,144 different shades. This Amiga-like capability has been achieved by the inclusion of an Inmos G-171S Colour Look-Up Table (CLUT) chip.



FIXED DISC FORMATS IBM has, not surprisingly, provided hard discs across the entire range of PS/2 machines. They are available as an option on the Model 30 and as standard on the remainder of the range.

Most machines in the range are fitted with the ST-506 controller. The exceptions are the Model 80 machines, which will be fitted with a new type of hard-disc controller that uses the Enhanced Small Device Interface.

The average access times for the hard discs as provided by IBM are not impressive. For example, the 20Mbyte hard disc on the Model 50 has an average access time of 80ms., while the 80386-based Model 80-041 can only manage 40ms. for its 40Mbyte disc.

Much of the discrepancy can be put down to the lower data density on the smaller discs. However, our own Bagshaw Benchmarks produce results which are much more favourable. The Model 30 produced a hard-disc timing of 87.8 seconds while the Model 60-041 hard disc achieved 43 seconds. At the top of the range the Model 80-071 produced an outstandingly fast speed of 30.2 seconds.

MICRO CHANNEL LAYOUT

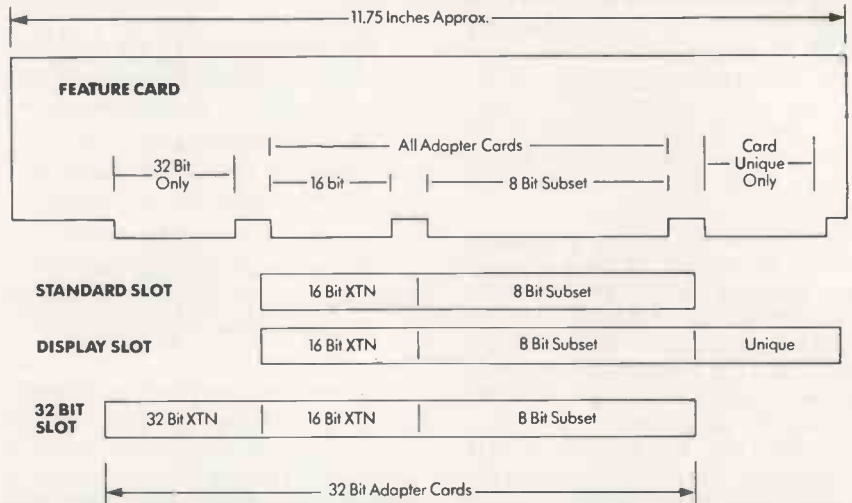

ARBITRATION BUS

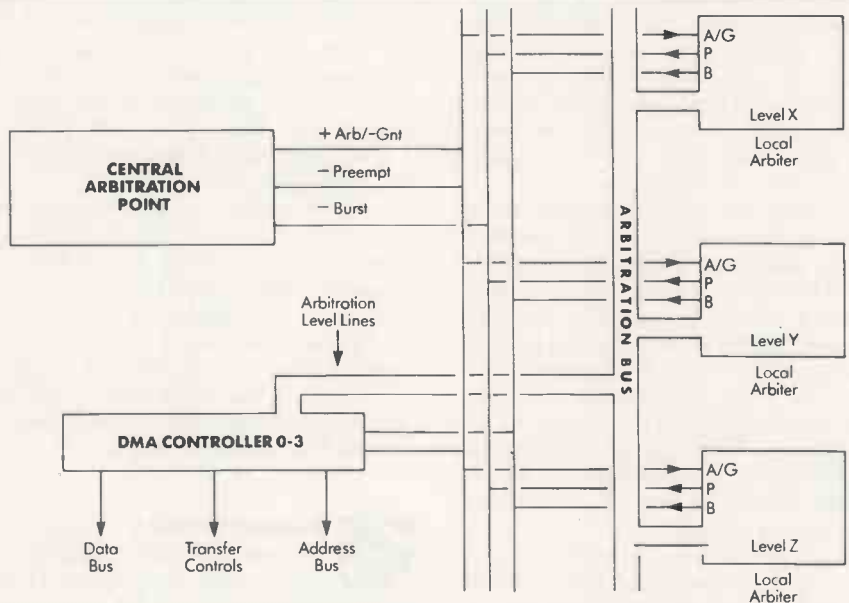

Top: The standard slot fitted to the Model 50 and 60 machines is a 16-bit subset of the Micro Channel. The Model 80 comes with a combination of 16-bit and 32-bit slots. A special 16-bit slot with an extension is required for the 8514/A video adaptor card.

Above: Cards request the use of the bus by sending their priority levels along the arbitration bus. Low-priority cards drop out in turn until just one remains. If a card wishes to perform multiple data transfers it sends a signal along the burst channel, which causes the CAP to suspend arbitration, but if it holds on to the bus too long it is suspended until all other devices on the bus have a chance of access.



THE MICRO CHANNEL Of all the innovations introduced with the PS/2 series, the one that is going to have the most profound long-term effect is undoubtedly the Micro Channel. It is here that the PS/2 machines deviate furthest from the accepted PC

standard, and of all the innovations the Micro Channel both holds the greatest potential and is the most likely to cause would-be clone manufacturers serious problems. It is implemented on all the machines except the Model 30.

The Channel itself has a 32-bit architecture, although on the 80286-based

PC NETWORK BASEBAND



Hidden among the new range of micros, IBM announced an addition to its range of networks.

The new system, to be called PC Network Baseband is a low-level departmental system for up to eight stations. It uses daisy-chain wiring to hook the computers together. The network is organised as a CSMA/CD network with a data rate of 2Mbaud.

The PC Network Baseband supports the IEEE 802.2 standard for interfacing at the Data Link layer and is equipped with IBM's new Enhanced Net BIOS, which has

machines it is implemented as a 16-bit subset. There have been two main forces which have impelled the development of the Micro Channel. The first, and more mundane, is the U.S. Federal Communications Commission rules on the emission of radio signals from electrical devices. The second motive is the need to arbitrate between the even more complex and demanding expansion cards currently under development.

Every fourth connection on the Micro Channel expansion slots is an earth line. The result is that no pin is more than one away from an earth line; this provides a partial screening and prevents the lines interfering with each other.

The Channel itself is built up from a collection of buses with control protocols built around them. One of the greatest benefits to the end-user is that the new Micro Channel architecture does away with the need for DIP switches and other selection paraphernalia that the PC user has had to put up with. Each card which uses the Micro Channel will be assigned a unique 16-bit identification number. IBM has set aside 65,536 of these numbers, half of them to be licensed to outside manufacturers.

A record of the cards that have been installed on the system is kept in battery-backed CMOS RAM. If the machine's bootstrap program notices a new number, it will look for an Adaptor Description File which tells the Micro Channel what resources the card needs. An Adaptor description file will be provided on floppy disc, and will normally be copied into CMOS RAM and on to the hard disc when the card is installed.

The old PC bus does little to arbitrate between the demands of different cards. This means that when certain cards grab the bus, others are unable to function. IBM has got round this with a concept borrowed from its mainframe design and known as the bus master. Any card which requires access to the bus bids for it by sending its priority number down the line. Cards drop out of the bidding when they discover that another card has a higher priority, until there is a single card left, which is given access.

a cleaner interface to the lower levels of the ISO seven-layer model. IBM says that the Enhanced Net BIOS will now be made available across its range of network operating systems.

To expand the system beyond the basic eight stations IBM is offering a PC Network Baseband Extender. This unit can link together up to 10 of the daisy-chains, giving a maximum limit of 80 machines on the network. The price of the new network makes it the cheapest in the IBM range, with an average cost per node in the region of £400.

FAMILY PORTRAIT

THE PERSONAL SYSTEM/2 ENCOMPASSES A RANGE OF MACHINES EXTENDING FROM LITTLE MORE THAN AN UPGRADED PC TO AN 80386-BASED SUPERMICRO.

STEVE MALONE HAS BENCHTESTED THEM.

Four models in the Personal System/2 range have been announced: the Models 30, 50, 60 and 80. The Model 30 will be hitting the streets first. Like its cousins it is housed in a modern-looking plastic box, and is fitted with a new keyboard and 3.5in. disc drives. Measuring 16in. by 15.6in. by 4in., the Model 30 is considerably smaller than any desk-top machine that IBM has previously produced.

The keyboard adopted for the PS/2 range has the same layout as that which has recently become standard for AT and XT machines. It has a separate numeric keyboard and cursor-control cluster, and 12 function keys across the top.

IBM does not bundle the keyboard in with the rest of the machine; it costs another £185 on top of the machine's price. The keyboard plugs into a small seven-pin DIN socket at the back of the machine. This means that unless you are handy with a soldering iron you will not be able to avoid paying the extra price simply by plugging in your old keyboard.

On the front of the Model 30 is the IBM badge — now tilted at a rakish angle — either one or two 3.5in. floppy-disc drives, power and drive LEDs and the on/off switch. Along the bottom there is a generous grille to allow throughput of air.

Before the new family of machines was announced it was widely predicted that IBM would fit the commonly used I/O ports on to the motherboard. This is what the company has done, although it turns out that there are one or two surprises. The entire range is fitted with a mouse port which again connects to a seven-pin DIN plug. The mouse itself and its driver software are licensed from Microsoft and will cost £60.

The other I/O interfaces are less surprising. All the machines in the range are fitted with parallel printer port, a 25-way RS-232 serial port — although this is a departure for IBM — and a standard nine-pin RGB socket for the monitor. Also on the back of the machines is a security lock. Whereas the lock on ATs disables the keyboard, the PS/2's lock protects the innards from unauthorised access. Software security is provided by password protection on power-up.

There are two versions of the Model 30. The Model 30-002 has twin 3.5in. floppy discs, while the Model 30-021 is fitted with a single floppy drive and a 20Mbyte hard disc. The Model 30's floppy discs have a formatted capacity of 720K.

IBM has finally abandoned the old 8088 CPU which has served it so well. Instead the company has given its entry-level machine a 16-bit 8086 processor running at 8MHz. A full 640K of RAM is fitted as standard, and there is a socket to hold an 8087 maths co-processor if it is required.

While the Model 30 has been lumped together with the Personal System/2, inside it bears many of the hallmarks of the old PC range. For example, while most of the chips are fitted to the motherboard with the new surface mount technology, the old BIOS ROMs remain firmly in their sockets. Unlike machines in the rest of the range, Model 30s are not equipped with a Micro Channel; instead they have a back-plane bus which can hold three of the old eight-bit PC expansion boards.

This expansion configuration raises several questions which the IBM people we spoke to were unable to answer. To begin with, why eight-bit slots? The 8086 is a full 16-bit processor and should therefore be able to handle the AT's 16-bit cards. One possible reason might be that as the cards would be sideways mounted, there would not be room in the system box for the full-size, AT-style cards. But the XT-286, which has a similarly restricted space, can take 16-bit cards. Perhaps IBM does not expect enough PC-sized 16-bit cards to be produced to make it worthwhile.

The Model 30 contains four of the five custom VLSI chips described on page 89. The 16-channel DMA controller, the I/O management chip, and the processor-control chip also appear in other models in the range. The MCGA video chip is unique to the Model 30.

The Model 30 is a very different animal from the other members of the PS/2 family. The lack of the Micro Channel and VGA video chip used with the other models means that it cannot really be considered as an entry-level machine for the PS/2 series. On the other hand, the 3.5in.

IBM is clearly repositioning its PC line as an extension to its systems strategy, and trying to gain a hold on users that seem to make more sense for IBM's marketing status than for end-user's needs. IBM has moved away from the industry standard, thereby isolating over eight million industry-standard personal-computer users, 40 million software packages and 32 million peripheral products.

COMPAQ ▶

SPECIFICATIONS

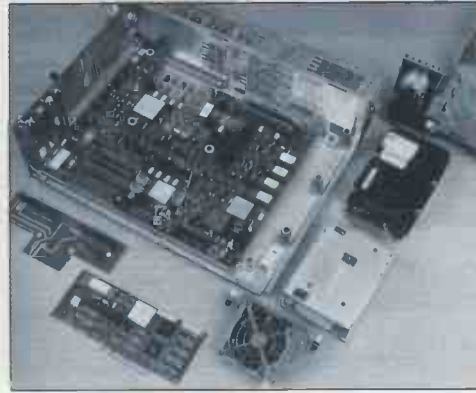
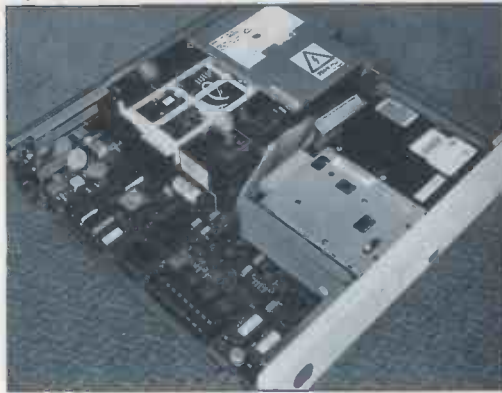

MODEL 30

CPU: 8086 running at 8MHz; socket for 8087 co-processor
RAM: 640K
Interfaces: RGB, parallel printer, 25-way RS-232 serial, mouse
Display: MCGA with maximum character resolution of 80x25 and pixel resolution of 640x480
Mass storage: twin 720K 3.5in. floppy-disc drives on Model 30-002; one floppy drive and one 20Mbyte hard disc on Model 30-021
Expansion: three eight-bit PC-style slots
Price: Model 30-002 £1,106, Model 30-021, £1,559; keyboard £189 extra
Available: now

MODEL 50

CPU: 80286 running at 10MHz; socket for 80287 co-processor
RAM: 1Mbyte
Interfaces: parallel printer, 25-way RS-232 serial, RGB, mouse
Display: maximum character resolution 25x80 characters;

Top row: The Model 30 (left), Model 50 (centre) and Model 60 (right). Bottom row: The Model 30 (left) has a backplane bus. The Micro Channel makes its debut in the Model 50 (centre). The Model 80 (right) offers eight expansion slots.

maximum pixel resolution 640x480
Mass storage: one 3.5in. 1.44Mbyte floppy-disc drive and one 20Mbyte hard disc
Expansion: three 16-bit Micro Channel slots
Price: £2,847
Available: July

MODEL 60

CPU: 80286 running at 10MHz; socket for 80287 co-processor
RAM: 1Mbyte
Interfaces: parallel printer, 25-way RS-232 serial, RGB, mouse
Display: maximum character resolution 25x80 characters; maximum pixel resolution 640x480
Mass storage: one 3.5in. 1.44Mbyte floppy-disc drive plus one 44Mbyte hard disc on Model

60-041, or 70Mbyte hard disc on Model 60-071
Expansion: seven 16-bit Micro Channel slots
Price: Model 60-041 £4,075; Model 06-071 £4,464
Available: July

MODEL 80

CPU: 80386 running at 16MHz; Model 80-111 is clocked at 20MHz
RAM: 1Mbyte on Model 80-041; 2Mbyte on Models 80-071 and 80-111
Interfaces: parallel printer, 25-way RS-232 serial, RGB, mouse
Display: maximum character resolution 25x80 characters; maximum pixel resolution 640x480
Mass storage: one 3.5in. 1.44Mbyte floppy-disc drive plus one 44Mbyte hard disc on Model

80-041, or 70Mbyte hard disc on Model 80-071, or 115Mbyte hard disc on Model 80-111; a second hard disc can be fitted as an option
Expansion: four 16-bit and three 32-bit Micro Channel slots
Price: Model 80-041 £4,916, Model 80-071 £5,757, Model 80-111 £7,245
Available: Models 80-041 and 80-071 available third quarter 1987, Model 80-111 available fourth quarter 1987

EXTRAS

Monitors: 8503 monochrome monitor £201, 8512 colour monitor £505, 8513 colour monitor £583, 8514 colour monitor £1,204
Display adaptor: 8514/A colour display adaptor £853
Keyboard: standard IBM keyboard £185
U.K. distributor: IBM U.K. Ltd, National Enquiry Centre, 414 Chiswick High Road, London W4 5TF. Telephone: 01-995 7700

(continued from previous page)

discs mean that it is not really a member of the PC family either.

So where does the Model 30 fit into IBM's grand strategy? My own opinion is that the Model 30 is a first-stage booster for the PS/2 rocket. Over the next few months it will be the only PS/2 machine available, but it will get software houses and customers used to the idea of the PS/2 format.

The Models 50 and 60 will take over once the PS/2 series is off the ground. At that point the Model 30 will be jettisoned. This is not to say that IBM will stop making the machines completely, as many people will be happy to remain with the old IBM PC standard.

The second machine in the range is the Model 50. Externally, it is very similar to the Model 30, with its keyboard, neat system box and 3.5in. disc drive. The

floppy drives on the Model 50 and models higher up the range have 1.44Mbyte capacity, though they can also read 720K discs. The Model 50 has a 20Mbyte hard disc included as standard. On the back there are three openings for vertically mounted expansion cards.

The Model 50 is fitted with an 80286 processor clocked to run at 10MHz. There is 1Mbyte of RAM and provision for a maths co-processor on the motherboard.

Like the Model 30, the Model 50 has CBIOS ROMs included in sockets. In preparation for the arrival of Operating System/2, two extra ROMs have been included. Between them they contain the 64K of Advanced BIOS code which will provide the hooks that are to be used by OS/2 when it arrives.

The Model 50 marks the first appearance of the Micro Channel. At first sight the most striking characteristic of the Micro Channel slots is their small size, which leaves plenty of space for IBM to pack other chips on to the motherboard. Two of the Model 50's three slots are for the 16-bit subset of the Micro Channel, while the third has an extension with extra pins that will take the new 8514/A graphics adaptor. But for normal purposes, most people will stick with the graphics provided by the on-board VGA chip.

The Model 60 is conceived as the power user version of the Model 50. The chips used, the clock speed and the Micro Channel are all identical to those of the Model 50. The main difference is that it has seven expansion slots and comes in a floor-standing casing. On the front of the machine there is an on/off switch, LED indicators for power and hard-disc activity, and a horizontal floppy-disc drive. There is also space for a second floppy drive to be fitted.

At the back are the openings for eight expansion cards alongside the serial, parallel, monitor, mouse and keyboard ports. To expose the motherboard you have to unlock the unit and turn two large screws on the cover unit on the right-hand side of the case. Inside, there is room for seven 16-bit expansion cards on the Micro Channel; the eighth is used for a hard-disc controller.

Because the Model 60 has additional

With Personal System/2, personal computing has come of age. The user has what he or she wants: powerful processing to handle their individual application requirements. At the same time, data processing and communication are back within the control of the corporate information-services environment.

DIGITUS

expansion slots it needs a bigger power supply. The Model 30 has a 70W power supply while the Model 50 has a 94W unit. The Model 60 has a healthy 204W at its disposal, which should support almost any combination of boards that you can imagine. One feature of the power supplies which will prove to be a boon, both to travelling users and to IBM, is that they can detect the voltage of the mains supply to which they are attached.

At the top of the range is the Model 80 — IBM's eagerly awaited 80386 32-bit machine. Externally, it looks similar to the Model 60. There are three versions of the Model 80: the 041, the 071 and the 111 with 40Mbyte, 70Mbyte and 115Mbyte hard discs respectively. The 80-041 and 80-071 run at 16MHz, while the 80-111 will have a 20MHz clock speed.

The Model 80 has a total of eight expansion slots although, as on the Model 60, one of them is given over to the hard-disc controller, leaving a total of seven slots free. Four are 16-bit slots and three are 32-bit.

BASIC BENCHMARKS

The Basic Benchmark ratings came out as 6.62 seconds for the Model 30, 3.38 seconds for the Model 50 and Model 60, and 1.83 seconds for the Model 80. These results raise several interesting points. To begin with, the 8086-based Model 30 manages to beat competitors with a similar specification. It is one-third of a second faster than the Amstrad PC-1512 and over half a second faster than the Olivetti M-24.

The timings for the Model 50 and Model 60 machines are a respectable 3.38 seconds. Last month we reviewed the Compaq Portable III — which also has an 80286 processor but which is clocked at 12MHz — and it produces a Basic Benchmark average of 2.8 seconds. The faster clock speed is sufficient to give the Compaq machines the edge.

IBM can gain some consolation with the Model 80. The machine we Benchmarked used the 16MHz version of the 80386 processor rather than the 20MHz version promised for the end of the year. But even though it uses an identical processor running at an identical speed to the Compaq Deskpro 386, the Model 80 manages to win by a nose, the figures for the Deskpro 386 being 1.89 seconds.

Quite how the Model 80 manages to squeeze ahead of the Deskpro 386 raises some interesting questions about the design. IBM told us that the Page Burst Mode RAM is not fitted to the early models of the Model 80, and will only be on the 20MHz Model 80-111. The machine we used had ordinary DRAM fitted, as opposed to the Deskpro's static-column RAM chips. Looking solely at the specifications, the Compaq should therefore be faster. Although no one we spoke to at IBM claimed to know the reason, the feeling we gained was that the faster speed is a result of the Micro Channel architecture. The bus arbiter and DMA control take over many of the tasks which would otherwise be undertaken by the CPU, freeing the processor for computational tasks.

OS/2

IAN STOBIE LOOKS AT THE OPERATING SYSTEM THAT WILL MOULD IBM PERSONAL COMPUTING FOR THE NEXT DECADE.

In the short history of the micro industry few announcements have been of such far-reaching importance as that of the new system software designed to accompany the Personal System/2. The rules of the game for both developers and users have been changed.

Among the large number of new products, OS/2 is the key. It is the officially approved heir to MS-DOS, and everything else makes sense in terms of it. Both Microsoft and IBM declare OS/2 to be the future mainstream operating system for business personal computers. They expect it to remain stable for the next 10 years.

At a stroke, OS/2 takes care of all the annoying limitations of MS-DOS, such as the restricted memory addressing and the lack of a standard way of handling multi-tasking and pop-ups. OS/2 is designed to take advantage of the higher performance of modern processors, screens, storage devices and printers as they become available. While being the way forward to the future, OS/2 is not unfamiliar: to both users and programmers it looks very similar to Microsoft Windows.

Having said all this, MS-DOS itself is not dead. To emphasise the point, Microsoft is launching a new release, version 3.3, which will be available immediately. MS-DOS 3.3 will be the standard operating system for the junior member of the PS/2 range, the Model 30, as well for other 8086-based machines from IBM and other manufacturers. OS/2 will only run on machines based on the powerful Intel 80286 and 80386 processors, and their future successors.

In practice MS-DOS 3.3 will initially also be the standard operating system for the Model 50, Model 60 and Model 80 machines as OS/2 will probably not percolate through to end-users before the beginning of 1988. So far it is not even available in beta-test form. Complicating the launch schedule even more, IBM intends to release OS/2 in three stages, while Microsoft is launching it in one go. OS/2 itself is not proprietary to IBM, though in its final stage IBM will incorporate some proprietary comms and database extensions of interest to larger corporate users.

Microsoft is also launching a new version of Microsoft Windows, version 2.0. It will have an identical user interface to OS/2 and supports all the graphics modes of the new IBM machines. It is scheduled to go on sale in the third quarter of this year with an end-user price of £75, so it is an obvious

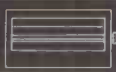

MULTI-USER SYSTEMS

DESK TOP PUBLISHING

ON SITE TRAINING

ON SITE SERVICING

AFTER SALES SUPPORT

**CALL FOR A PRICE
AND GET
PROFESSIONAL ADVICE
(0280) 816087**

Visit our demonstration showroom and see the complete Apricot range including the Xen multi-user system.

Also see Apricot's high performance Desk Top publishing system incorporating Aldus PageMaker and both the Kyocera and the Apple Laserwriter Plus printers.

Bristle Hill Buckingham
Bucks MK18 1EZ
(0280) 816087



apricot

Panasonic
Office Automation **OA**

EPSON

Amstrad

FRASER
Associates Limited

→ circle 145 on enquiry card ←

The 'Classic' Menu Generator.

Eliminate all user contact with operating system commands. Use **MENUGEN** from Microft Technology to create menus to access all your regularly used programs.

MENUGEN is a utility which will create menus for any activity. A menu selection will run a program, call another menu, return to a previous menu, run a basic program, execute operating system commands, or exit to the operating system.

User Ltd. Selection Menu

- 1 ASPECT
- 2 Wordstar
- 3 Lotus 123
- 4 Disk formatting menu
- 5 Exit to operating system

Please type in selection number

FACILITIES INCLUDE

- UP TO 20 MENU OPTIONS PER MENU SCREEN
- UP TO 15 LEVELS OF NESTED MENU
- ANY NUMBER OF LINES OF HEADINGS AND FOOTNOTES
- USE OF COLOUR - FULLY USER DEFINABLE
- ARE YOU SURE? MESSAGE OPTION AFTER ANY SELECTION
- PROMPTING FOR UP TO 16 PARAMETERS AFTER ANY SELECTION
- OPTIONAL PASSWORD PROTECTION ON MENU SELECTIONS
- OPTIONAL LOGGING OF ALL SELECTIONS TAKEN

MENUGEN is available for most CP/M, MS DOS or PC DOS micros including IBM PC/XT/AT and compatibles, Sirius, Apricot, HP150, DEC Rainbow, and many Z80 machines. **MENUGEN** costs £48 + VAT (£55.20) for a single user licence, or £120 + VAT (£138) for a network licence, and is available from Microft Technology Limited, The Old Powerhouse, Kew Gardens Station, Kew, Surrey TW9 3PS. To order, or for further information, telephone 01-9488255.

MENUGEN

MENUGEN is a Trade Mark of Microft Technology Ltd and is a British product.

→ circle 146 on enquiry card ←

M-TEC NEW RELEASE BBC BASIC (86)

for

**PC compatibles, running MS DOS
£95 + VAT**

Now you can use your favourite language
with your favourite operating system

the features of BBC BASIC including:

- Multi-lined named procedures.
- In-line assembler using standard mnemonics.
- Serial random and indexed disk files plus the ability to access any byte in the file.
- BBC Basic VDU commands; graphics; sound.
- Full screen editing.

*You need never say GOTO again — but
we won't stop you*

Available from:

M-TEC COMPUTER SERVICES (UK)
Ollands Road, Reepham, Norfolk NR10 4EL
Tel: 0603 870620

→ circle 147 on enquiry card ←

ZORLAND

VERSION 2

FOR IBM PC/AMSTRAD 1512



NEW! LATTICE/UNIX/ANSI Compatible!
Now Zorland C is even more compatible! It is probably the most up-to-date ANSI standard C compiler on the market today! Why waste hours waiting for programs to compile! ZORLAND C is 3 TIMES FASTER! Even major companies like IBM, XEROX and FUJITSU use ZORLAND C!

NEW! Integrated Compiler/Editor Environment! Our new environment is truly amazing! Gives TOTAL control! It's a wonderful way to program in C! Compile in memory! Edit FIVE files at once! Keyboard Macros! "123" style menus! On-Line Help! Compiling C programs has never been so easy!

NEW! Massive 350 Page Manual! The tutorial takes you step-by-step into the World of C! Start with the "idiots" guide and then (hopefully!) — move on! Build-up to the more advanced features! Lots of examples! Over 210 functions explained! Write your own libraries!

NEW! ZORLAND BTREE/ISAM DATABASE package. Get your business application off to a flying start! Includes FULL SOURCE CODE and an example indexed Name & Address application showing how easy it is! Supplied complete and ready-to-go with our great 70 page manual!

Only £29.95 + vat!

NEW! ZORLAND WINDOWS gives your program that professional look — just like "Framework" and "123"! Fast Exploding and Zooming windows with automatic saving and buffering in memory. "Pop-Up" and "123" style menus — comes with fantastic demo progs and 50 page manual! FULL SOURCE CODE!

Only £29.95 + vat!

NEW! ZORLAND OPTIMIZER! will "fine-tune" your progs during compilation by running a THIRD pass to OPTIMIZE your code using state-of-the-art "Global Optimizing" techniques found only on mainframe C compilers! Now you can squeeze that last ounce of speed out of your code! Does NOT replace assembly code! — Does NOT replace good programming!

Only £29.95 + vat!

Here's your chance to save over £300! Buy ZORLAND C at £29.95! Learn how to use our industry standard C compiler! The same as LATTICE and MICROSOFT! ZORLAND C applications are even being ported up to VAX mainframes! ZORLAND C is three times faster than the Giants! One tenth the price! No wonder most U.K. universities and polytechnics are now switching to ZORLAND C!

Save £300!

TECHNICAL SPECIFICATIONS — POWER PACK — A complete FULL K&R specification C compiler with ALL the UNIX V extensions and ANSI enhancements! Supports & emulates 8087/80287 maths co-processor, assembly language interface, Compact, Small, Data & Large models, includes FULL SOURCE CODE to the library, over 210 functions! Including trigs, fast screen access, disk sector read/write, dos/bios calls, interrupts, etc. 64 bit precision. MS-LINK compatible linker and librarian are included together with many UNIX programming utilities like MAKE and TOUCH. Powerrrrrrfull!!!

★ ZCNEWS MAGAZINE! Now ZC Users have their own monthly magazine containing articles on a whole range of topics for ZC enthusiasts! You can submit an article for publication with the opportunity of winning a £250 prize for "Article of the Month". Each issue contains at least 30 pages full of interesting articles for C programmers!

★ ZC USER GROUP! FREE! Subscription to ZCNEWS gives you free membership! Here to help you get technical support and quality control that you need! Telephone hotline provided for members who need to talk through any problems. ZCNEWS/ZC USER GROUP £15.75 p.a.

Highly Recommended Books!



C Primer Plus — £19.95
This 500 page book from USA is highly recommended for those new to C! It takes you through the basics in an easy to follow, easy to read, enjoyable style. It has many example programs that utilize sound, graphics and disk files.

Advanced C Primer — £19.95
This 500 page book starts were most other books stop! It gets right down to the nitty gritty of File I/O, PC Memory, BIOS & DOS calls, Graphics displays and integrating your Assembly Language routines into your progs.

Yes, Send me ZORLAND C now!

- ZORLAND C £34.44 inc. vat.
C compiler with integrated editor and big 350 page manual
- DEVELOPER'S UPGRADE £22.94 inc. vat.
Allows you to compile progs larger than 64k (P,D,L models) and includes FULL LIBRARY SOURCE CODE!
- LINKER/LIBRARIAN £22.94 inc. vat.
MS-DOS compatible LINK.EXE prog and Librarian for creating your own
- ZORLAND C POWER PACK! £68.94 inc.vat.
SAVE £101 Buy all three for only £59.95! This is the full ZORLAND C compiler with the DEVELOPER'S UPGRADE and LINKER/LIBRARIAN!
- ZCNEWS/ZC USER GROUP £15.75 inc.
12 issues of ZCNEWS direct to your door, plus ZC USER GROUP membership.
- C PRIMER PLUS £19.95
500 pages for beginners!
- ADVANCED C PRIMER £19.95
500 pages for advanced users!
- BTREE/ISAM DATABASE £34.44 inc.vat.
- ZC WINDOWS LIBRARY £34.44 inc.vat.
- OPTIMIZER KIT! £34.44 inc.vat.

Name _____

Address _____

For Overseas AirMail orders please add £5.00.

TO: ZORLAND LTD, 65-66 WOODROW, LONDON SE18 5DH
Tel:01-854 1194 (4 lines) Fax:01-317 1284



(continued from page 93)

bridge product for anyone wishing to get a taste of OS/2.

Other announcements from Microsoft and IBM include a new LAN manager for OS/2, which will be available later this year. A software development kit for OS/2 will be available from August, giving developers a chance to get OS/2 applications running ahead of the end-user launch. It will cost £2,500 including a training course and telephone support.

According to Microsoft its own OS/2 and IBM's OS/2 are identical products. The relationship is even closer than that between MS-DOS and PC-DOS: Microsoft is licensing the product to all its existing MS-DOS OEMs, including Compaq, Apricot, Research Machines and Olivetti.

The role of the 128K firmware built on to the main board of the IBM PS/2 machines is not yet entirely clear. Half of it is there to ensure compatibility with MS-DOS; the mystery is over the other 64K, which IBM calls Advanced BIOS. According to Microsoft, OS/2 will run happily without it, so there is no need for other manufacturers to rush out and try to clone it. But does Advanced BIOS boost OS/2 performance? We await a review system with interest.

The OS/2 project goes back to August 1985, when Microsoft and IBM signed an agreement to develop a new-generation operating system for the 80286 and 80386 processor families. In effect this put the seal on a tri-partite alliance between Microsoft, IBM and Intel, maker of the chips. This is the basis of IBM and Microsoft's confidence in the long-term future of the operating system. Judging by its past record, any 80486 or even 80586 chips developed by Intel should run the same binary code.

Some of the system software announced for the PS/2 range is proprietary to IBM, but this is additional to OS/2 proper. It mainly takes the form of the communications manager for 3270 terminal emulation and the SQL-compatible database manager contained in the IBM OS/2 Extended Edition, which is scheduled for release during 1988. Both the 3270 and SQL are already established as industry standards.

IBM is unlikely to try and stop third-party suppliers offering similar features to those contained in the Extended Edition so long as they do not directly copy the code. It looks like it will be relying on reputation and salesmanship to defend its patch rather than technical obstacles or the law.

IBM is bandying the term Systems Application Architecture (SAA) a great deal at the moment. OS/2 is a key part of SAA, as is SQL. The idea is that one day all IBM systems, at micro, mini and mainframe level, will work in broadly the same way. This is not true at the moment, but IBM has been taking a hammering from DEC, whose range is more integrated. SAA is designed to counter this threat.

MS-DOS AND OS/2 MEMORY MAPS

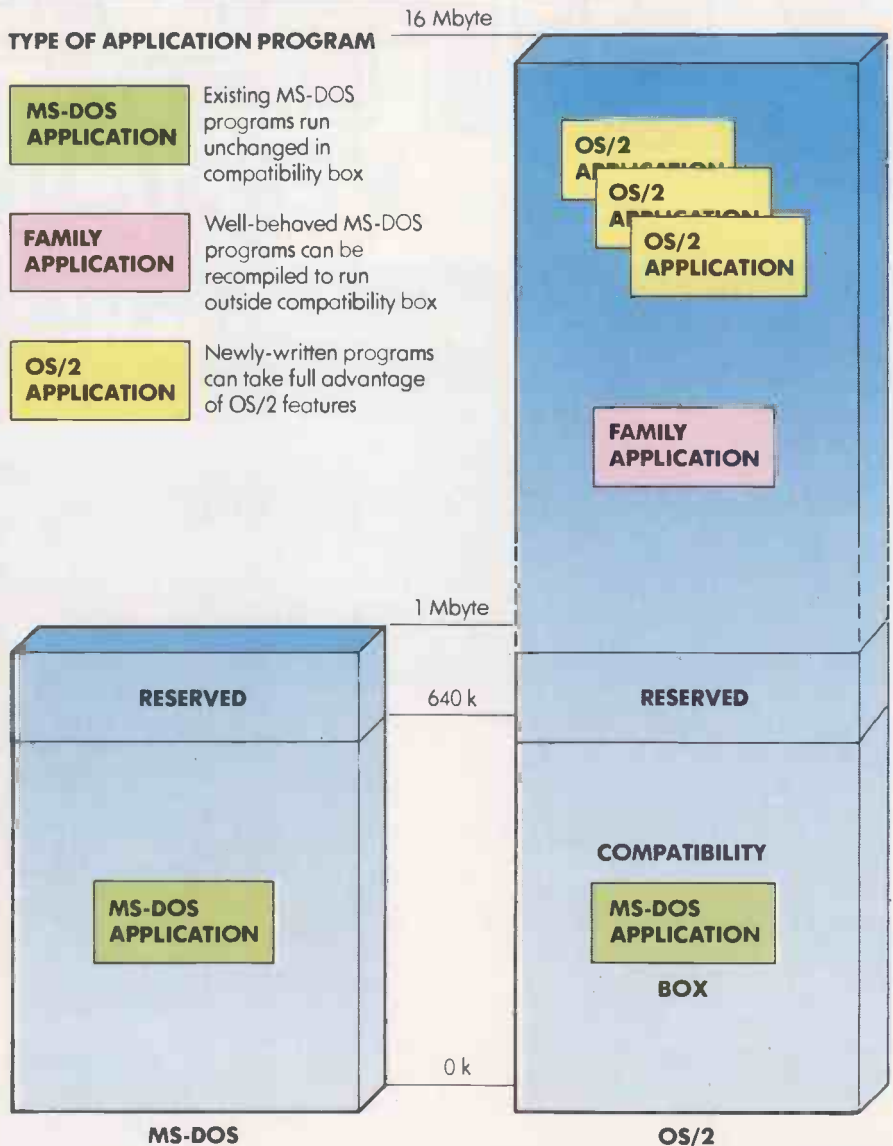

OS/2 gives you 16Mbyte of memory to play with. You can run MS-DOS applications in the 640K compatibility box at the bottom of memory.

At the moment SAA exists mainly on paper. IBM is steadily publishing details of what the future should look like, defining things like communications protocols and key aspects of the user- and program-level interface. OS/2 is one of the very first products to conform to SAA.

OS/2 is a complex product. The code itself is about 400K long — about 10 times as large as MS-DOS — although generally it is not all loaded in memory at any one time. Much of the code is devoted to making things simpler for the user — replacing the unhelpful MS-DOS command line with a Mac-style, user interface closely based on Microsoft Windows, and making software and hardware installation simpler.

Conceptually, OS/2 divides up into two parts. The kernel looks after hardware-related functions like task scheduling, disc

accessing and memory management, while Presentation Manager handles all aspects of the user interface. This distinction is already present in the code for the existing Windows product, but it was not implemented very cleanly. Now the kernel code and presentation code are kept completely distinct.

The Presentation Manager is outwardly very similar to Windows. It replaces the MS-DOS command line with a system of pull-down menus, icons and windows. You can control them with a pointing device such as a mouse, or from the keyboard. It also makes these facilities available to applications programs, so IBM programs should start developing a strong common style, as is already the case with Macintosh applications. Presentation Manager also provides cut and paste functions for transferring graphics and text between different applications.

Microsoft has made one significant change from the original Windows interface. Windows will now overlap in the same way they do on the Macintosh or with

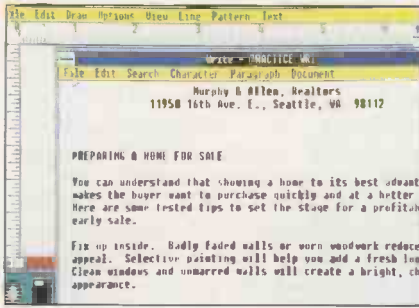

OS/2 and the latest version of Windows (above) look identical. You will be able to run several tasks at the same time in a series of overlapping windows.



Gem, rather than being tiled as on the original Windows. Although this changes the feel of the product quite substantially, it is a trivial change in terms of the coding involved. To preserve compatibility, tiling is retained as an option which programmers can specify.

The whole point of an operating system is to shield application programs from the details of using the hardware. This way the same application can work on numerous different types of machine, and it will keep running happily as hardware technology changes. But with MS-DOS this ideal has only really been achieved as far as the discs are concerned. Software packages still have to be modified at installation time to support different displays, printers and memory cards.

With OS/2 drivers for things like printers or displays become part of the kernel — the real heart of OS/2 that runs the hardware. In principle they only have to be written once. OS/2 comes with most of the common hardware already supported. In the longer-term responsibility for writing new drivers will shift to the hardware developers. When you buy a new large-format display, for instance, it will come with driver software on disc, ready for you to incorporate into OS/2. All the software you already own should then work on the new screen without reinstallation or any other change.

The OS/2 kernel is already almost complete; it is the Presentation Manager which lags behind. This is why IBM plans to release OS/2 without Presentation Manager, in the form of the Standard Edition 1.0 which will use an MS-DOS style command line. IBM needs something

to show off the new PS/2 machines to advantage. The plan is for this quickly to be followed by Standard Edition 1.1, which is the full-blown product with Presentation Manager. The Extended Edition containing IBM's proprietary additions will follow some time later. Microsoft is not bothering with a provisional stage as it has no boxes to shift.

OS/2 supports the full 16Mbyte of main memory that can be directly addressed by the 80286 chip. This is likely to increase to more dramatic levels as further Intel chips become widely available, but initially OS/2 will offer the same 16Mbyte on both 80286- and 80386-based systems.

But from day 1, applications will be able to assume they have up to 1Gbyte — 1,024Mbyte — of memory available. The operating system will automatically swap chunks of data to and from disc to sustain the illusion: this is virtual memory management. It is often better to have the operating system handle large chunks of code or data in this way than for the application developer to do it explicitly.

All existing applications that run under MS-DOS version 3 or above will also run under OS/2. This is achieved in a crude but effective way. The bottom 640K of the address space is reserved for existing MS-DOS applications, and within it they can carry on as before, misbehaving to their hearts' content — directly addressing the screen, issuing software interrupts, making unofficial BIOS calls or whatever. Applications that run amok will be able to devastate the 640K area as in existing MS-DOS. But OS/2 itself resides in the area immediately above the bottom 1Mbyte of memory which is protected by the 80286 or 80386 chip, and so it cannot be overwritten.

Safety is one of the advantages that flows from having a machine that uses an 80286 or 80386 chip. Until now users have not been able to exploit it because even with an AT, MS-DOS did not support the 80286 protection feature. Under OS/2, the system detects any program which attempts to address memory which has not been allocated to it, or which tries to address a peripheral device or initiate a software interrupt in other than the prescribed way. The program can then be shut down, or the system can issue an appropriate error message or take other action. What you avoid is a system crash. This is why true multi-tasking applications really

The new products are good for the corporate users and the industry; the recent announcements have removed a great deal of uncertainty. This will release pent-up demand from corporate users, whose policy decisions are still based upon the IBM XT/AT range.

INTERQUADRAM

had to wait until the 80286 and an appropriate operating system like OS/2 became available.

Under OS/2, applications are divided into three classes. Initially the most numerous will be existing MS-DOS applications. They will run unchanged in the compatibility box — a kind of sin bin for badly behaved programs. Even pop-ups, which intercept the keyboard directly and contend with other applications for the screen, will run.

Some existing MS-DOS applications are well behaved. They do not directly address the screen, issue software interrupts or attempt to grab exclusive control of the keyboard. They use only the official hooks for getting into MS-DOS. These applications can be recompiled quite easily to run under OS/2 as an intermediate class of programs known as family applications. They can then run anywhere within the available address space. When run alongside other applications OS/2 will protect them, and protect the other programs from them.

The programs that fall into this class tend to be fairly boring in programming terms. Anything which demands high performance in interacting with the user — for instance, fast graphics or a quick mouse or keyboard response — probably breaks the rules somewhere along the line. Family applications are likely to be things like text-based accounting programs that use the screen in an uninteresting way, or utility programs with a simple user interfaces. Nonetheless, the family category allows a large number of bread-and-butter applications to be transferred across to the new environment with the minimum of programming effort.

Anything more ambitious will have to be rewritten to get the best from OS/2. Microsoft says that if the application already uses Windows this will not be very difficult to do. But for other software it could involve a substantial development effort.

One crucial issue is whether having to do things via the operating system in the way OS/2 requires will incur a performance overhead. For example, most existing interactive graphics programs, and even multiple-fount word processors, address the screen directly to run at an acceptable speed. Even Microsoft's own Word breaks the MS-DOS rules in this way. Both IBM and Microsoft say the penalty under OS/2 is slight — but then they would say that, wouldn't they. Assessment will have to await the arrival of the first OS/2 applications.

OS/2 is a multi-tasking operating system, but the OS/2 concept of a task is easily misunderstood and its significance missed. Few users will want to run nine copies of Lotus 1-2-3 simultaneously, but multi-tasking is important because it allows system-level tasks to be performed at the same time as an application program. For example, while typing text

(continued from previous page)

into a cell in Lotus 1-2-3 you could be printing another file and monitoring your RS-232 port for incoming messages. Your spreadsheet program could even be carrying out recalculations on the rest of the work sheet while you enter data into the cell.

A task is not the same thing as a program. Developers now have the option of dividing a program up into several tasks which can execute concurrently. This is likely to be particularly useful with complex corporate applications: while the user deals with a spreadsheet-like display another task can be off gathering data from across a network or via a mainframe link. In this example the user interface and the comms side of things would probably be handled as separate tasks within the same program.

Under the OS/2 regime pop-up programs like Sidekick, Ready or Tornado Notes will have to be rewritten to become tasks. This is not necessarily as daunting as it sounds, as much of the effort in writing a pop-up consists of making it interrupt other programs non-destructively, saving the state of the screen and so on, all of which should be rather simple under OS/2. In fact many applications should be easier to write and may take up less space under OS/2 because the operating system itself is capable of carrying out so many more functions.

Even with OS/2, multi-tasking is still something of a misnomer. On present commercial hardware — even on mainframes — tasks do not in fact go on more than one at a time. Multi-tasking is a sleight-of-hand effect that is achieved by switching very fast between different tasks. It is really time slicing rather than true multi-tasking.

The way in which the switch to a new task is generated is through an interrupt. Under MS-DOS, programmers would often get their programs to issue interrupts themselves when they wanted to grab control of the machine for some purpose. These software interrupts were much used as a way of doing things that require an operating-system-like function that is really a bit beyond the capabilities of MS-DOS. Once you set a pop-up program running, for instance, it uses a software interrupt to suspend your main application periodically while it checks to see if you have pressed the hot key to invoke it. Networking software has been another heavy user of MS-DOS interrupts.

OS/2 programs are not allowed to behave in this way. Instead they issue a system call to get access to a system server function, which then allocates time between all the tasks you have running on the system. Under MS-DOS the system had to wait until a task returned control, but OS/2 has the power to pre-empt. This allows it to time slice in a flexible way, allocating use of the system according to the priority of the tasks. For instance, it can

While IBM has made it very difficult for the clone manufacturers, it is good for the industry that IBM has continued with the open architecture as it leaves scope for third-party manufacturers to develop plug-in boards for the new systems. It is also very good for the industry that OS/2 will be shared with other hardware manufacturers. We were afraid that IBM might go its own way and fragment the market.

PC USER GROUP

give a sorting program periodic slices of the action while nothing much else is going on. It will also help with very time-critical tasks like driving a high-speed modem or reading in data from electronic instrumentation.

Despite the far-reaching nature of the OS/2 announcement, there are still some limitations. The 32Mbyte disc limit stays: if you have a 70Mbyte hard disc you can make use of it only by dividing it up into separate volumes, each no bigger than 32Mbyte. The reasons for this limit seem to be historical and it may disappear on future releases.

While updating the operating system Microsoft has taken the opportunity of speeding up disc performance. MS-DOS was optimised for the low-capacity discs current when it was first designed, but OS/2 is optimised for hard discs. As more mini and mainframe applications are ported down on to top-end PCs, the MS-DOS limit of 20 files open at any one time becomes burdensome. OS/2 can support 256, which should do for the time being.

Microsoft seems very confident that OS/2 will last a decade, though this may seem a very rash statement in an industry where an order-of-magnitude change in performance tends to turn up pretty regularly at three-year intervals. Part of the confidence stems from the commitment to the Intel family. As the 80386 succeeds the 80286, to be followed later by the 80486 and so on, it should be easy to move OS/2 onwards. It also comes from contemplating the power of existing mainframes. Most are 32-bit machines — and surely the 32-bit 80386 provides all the power anyone will ever need on a desk.

But this is risky thinking. Speech recognition in real time is just around the corner, with self-adapting software, image and character recognition, and endless other goodies imaginable. One thing is certain: gigabytes — even terabytes — of memory will be required, and with them new ways of organising it all. Roll on OS/3.

In recent years IBM has been one of the few companies to persevere with thermal-transfer printers for general office use. Most other manufacturers have either lost interest in the technology altogether or use thermal transfer only for printers aimed at specialised markets. But in among all the recent IBM announcements is the Quietwriter III, the company's latest thermal-transfer offering. Priced at £1,096 and scheduled to go on sale almost immediately, the Quietwriter III is intended to compete head on with daisy-wheels and even laser printers in word processing and other high-quality office work.

On the face of it thermal transfer has a lot going for it. First, it is very quiet as no impact is involved. Ink is transferred on to the surface of the paper from a special heat-sensitive ribbon. The heat is generated by a row of heating elements, so characters are built up from a pattern of dots as on an impact matrix printer. It is possible to pack a large number of these heating elements together in the print head, so print quality can be very good. The Quietwriter III has 40 such elements.

Historically the big problem with thermal-transfer printers has been getting them to work properly with a broad range of different papers. A second and even more intractable problem has been getting running costs down. Ribbons can only be used once, so their price and life is crucial.

Only IBM has really cracked the paper problem, using a unique proprietary variant of thermal-transfer technology.

SPECIFICATION

Print width: 132 characters at 10 characters per inch (cpi)

Ribbon: proprietary IBM resistive ribbon cartridge, with claimed life of 385,000 draft characters or 265,000 in Quality mode; replacement costs £14.76

Print head: 40 elements.

Maximum graphics resolution: 240 by 240 dots per inch

Founts: Courier at 10cpi, 12cpi and 17.1cpi, plus Boldface Proportional built-in; one cartridge slot for optional fount modules and downloading founts from disc

Claimed speed: 100cps in Quality mode, 80cps in Enhanced mode, 160cps in Draft mode, all at 10cpi

Noise: claimed 45dB(A)

Paper handling: friction feed standard, takes single-sheet plain paper up to 16.5in. wide; optional sheet feeders, envelope feeder and tractor

Compatibility: IBM printer-control codes; supports eight European character sets as standard, with others available on cartridge

Dimensions: 551mm.(21.7in.) × 380mm.(15in.) × 180mm.(7in.); weight 10.8kg.(24lb.)

Price: £1,096

Manufacturer: made by IBM in Holland for IBM Corporation of Armonk, NJ

U.K. supplier: IBM U.K. Ltd., National Enquiry Centre, 414 Chiswick High Road, London W4 5TF. Telephone: 01-995 7700

Available: late May

QUIETWRITER III

IAN STOBIE LOOKS AT IBM'S NEW PRINTER, WHICH COMBINES THE SILENCE OF A LASER AND THE FLEXIBILITY OF A MATRIX UNIT WITH PRINT QUALITY APPROACHING THAT OF A DAISYWHEEL.

The Quietwriter ribbon is the key to the process. It consists of a layer of meltable dye coated on to an aluminised plastic based. The print head itself does not get hot; instead the 40 tiny elements in the Quietwriter head make electrical contact with the ribbon, allowing current to pass through it. The metal functions as a resistor, so heat is generated inside the ribbon itself.

In practice this seems to lead to a good flow of the dye on to the paper, almost irrespective of the roughness of the surface. Print quality with the Quietwriter III is good, with none of the breaking away around the edge of characters which you tend to get on cheaper thermal-transfer printers such as those built into portable electronic typewriters.

In Quality mode the ribbon advance has been reduced so that there is now a slight overlap between characters. According to IBM, this extends ribbon life by 70 percent compared to previous Quietwriters, but does not reduce the quality. With replacement ribbons costing £14.76, and accepting IBM's figure of 265,000 characters per ribbon in Quality mode, ribbon cost works out at about 8p per page on the basis of a 250-word letter. This is still more than typical daisywheel or laser-printer running costs, but probably acceptable for low-volume users, given the reasonable initial purchase price of the Quietwriter III.

Speed in Quality mode is claimed to be 100 characters per second (cps) at the typical printing pitch of 10 characters per inch (cpi). Unlike most printer manufacturers, IBM is scrupulous in qualifying this as the burst speed. The company also quotes a figure of 55cps for Shannon text, which is probably a more reliable guide to throughput. Shannon text is a nonsense sentence which contains letters in the frequency and sequences typical of written English. On the basis of these figures the machine is a good deal quicker than a comparably priced daisywheel, and our impressions confirm this.

For printing on exceptionally rough-surfaced paper an Enhanced mode is available. Here burst speed drops to 80cps at 10cpi. The paper is held in contact with the ribbon for longer, and the ribbon is advanced more to give each character a completely fresh area of ribbon. This mode corresponds to the only mode available on previous Quietwriters, and is obviously the most expensive in ribbon. However, for

most of the time it should prove unnecessary to use it, even for quality work.

Draft mode is completely new to the Quietwriter III. Here you get a claimed burst speed of 160cps at 10cpi, and greatly increased ribbon life. The penalty you pay is quality: characters break up a bit around the edges, but the results still compare favourably with the draft output from most impact matrix printers.

The Quietwriter is a fairly big machine, especially if you have one of the optional automatic cut-sheet feeders installed. The standard model has a wide carriage, allowing you to print lines of 132 characters at 10cpi making it useful for spreadsheet work. A variety of paper-handling options are available, in addition to the basic manual friction feed. A single-bin sheet feeder capable of holding 100 A4 sheets can be obtained. IBM also offers a higher-capacity dual-bin feeder, and a twin-bin feeder which can be loaded up with 50 envelopes. A tractor-feed option is also available.

The machine is very quiet, even compared to a laser printer. As the head moves backwards and forwards across the paper you hear a kind of low shuffling noise, but it is very unobtrusive. There is no fan, so when the machine is not actually printing there is no noise at all.

The Quietwriter III obviously resembles a daisywheel printer in the job it is designed to do. But silence and speed are not its only advantages over a daisywheel. Every element in the head can be controlled, so the Quietwriter can print graphics and a wide range of characters and founts. According to IBM, software designed to support the IBM Graphics Printer and Proprinter ranges will drive the Quietwriter III without change. With the appropriate driver higher-resolution



The 40 elements in the Quietwriter's print head focus down to a small area in the tip. Heat is generated inside the special metallised ribbon, not in the head itself.

graphics modes are available, up to a maximum resolution of 240 by 240 dots.

The full IBM character set is supported, including graphics characters. The standard model available in the U.K. will also support seven other European languages. This feature matches the new multi-lingual code page supported by the new PS/2 machines. Four founts are built into the machine: Courier in three different sizes, and another fount called Proportional Bold. Most people will print using the 10cpi Courier fount, but smaller 12cpi and 17.1cpi can be useful for printing listings and spreadsheets. The Quietwriter's wide carriage is also suited to this role.

You can select founts and print modes from the control panel on the front of the machine, as well as under software control. Up to eight founts or sizes can be used on the same page. Indicator lights show which mode you are in and whether the ribbon or paper has run out.

Next to the front panel is a slot for inserting optional founts on cartridge. According to IBM, over 50 cartridges are already available, as Quietwriter II cartridges will fit the new model. They include several foreign-language founts. A typical cartridge contains four founts, or the same fount in four different sizes, and costs about £60. You can also download founts from disc using a special download cartridge which fits into the same slot and contains 16K of RAM.

CONCLUSIONS

■ IBM's revamped Quietwriter III is a most impressive machine. It is very quiet, even compared to a laser printer, it gives good output quality on most types of paper, and it can handle graphics.

■ Main differences over the previous Quietwriters are greater speed, a new fast draft mode, more built-in founts and better ribbon life.

■ IBM has made some headway in bringing ribbon costs down, but the Quietwriter will still cost more than a daisywheel or matrix printer to run, making the machine most suited to relatively low-volume use.

■ At £1,096 the Quietwriter is ideally positioned to fit the price/performance gap below the cheapest laser printers. It should prove a very strong competitor for the up-market daisywheel. 

Quietwriter III - Quality Mode
Quietwriter III - Draft Mode

THE NEW APRICOT 386 and VX SYSTEMS

Supplied by: The Computer Company.

Telephone: 01-882 8811

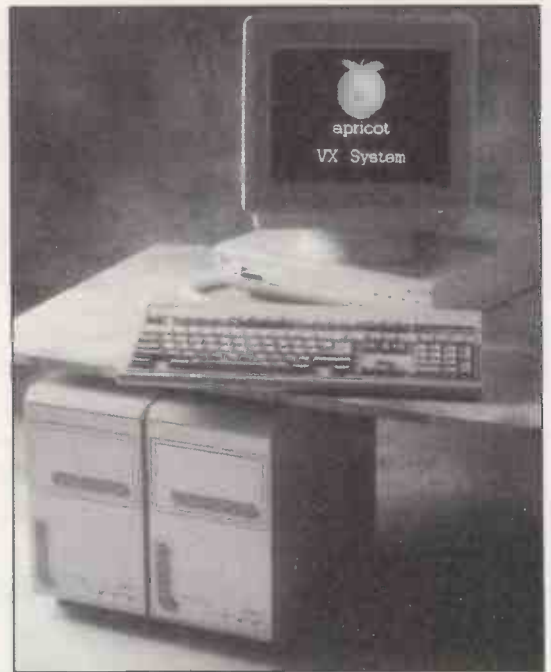
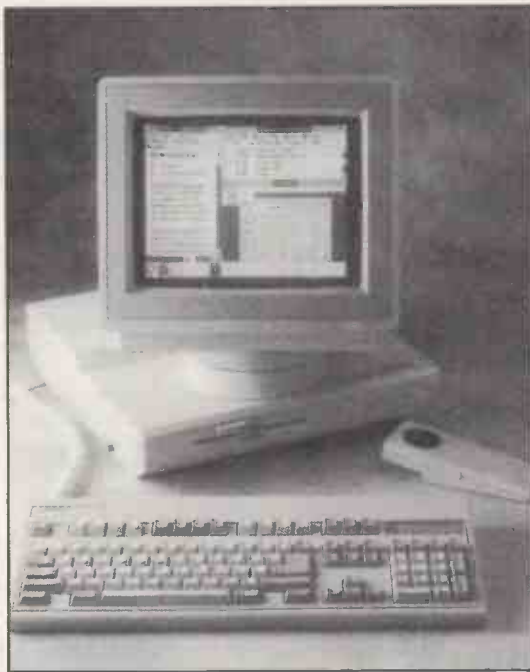

See the complete range of APRICOT systems SINGLE AND MULTI USER in our new showroom (car park to the rear, Southgate tube opposite)

Company Services include:
BESPOKE SOFTWARE
NETWORK PLANNING & INSTALLATION
ON SITE TRAINING
OWN IN-HOUSE TRAINING SCHOOL
CONSULTANCY
FULLY EQUIPPED IN HOUSE
MAINTENANCE WORKSHOPS
ON SITE MAINTENANCE CONTRACTS
AFTER SALES TELEPHONE SUPPORT
We can also provide telephone support for computer users that have not purchased systems from us using our annual telephone support contracts.

The Computer Company

2-16 Burleigh Parade
Burleigh Gardens
Southgate
London N14
Telephone No: 01-882 8811

APRICOT
PEGASUS ACCOUNTS
SOFTWARE
NOVELL NETWARE
XENIX 286/386

*Authorised Sales Service &
Support Centre*

→ circle 148 on enquiry card ←

The data protector.

(A SOFTWARE LOCK ON YOUR MICRO)

Is 'personal' data on your micro secured in accordance with the Data Protection Act?
Is sensitive data secure on your micro?

If the answer to either of these questions is NO then you need CLAM from MICROFT TECHNOLOGY. CLAM, as the name implies, provides a software 'shell' around your computer to prevent unauthorised access to programs and data. Once the simple task of setting up CLAM has been completed on any disk, the data can only be accessed through the user defined menus. (The menu system offers all the facilities of MICROFT's popular menu system MENUGEN.)

On starting the computer users are asked for a password. They then see on their menus only those options for which they have authority. If no valid password is entered at the third attempt no more tries are allowed until the computer has been switched off and then on again.

CLAM works by locking subdirectories. Users can only access those subdirectories for which they have authority. Only the copy of CLAM that locked a subdirectory can unlock it. Access is not possible by loading an operating system from another disk.



MAIN FEATURES

1. All data held on a hard or floppy disk can be kept secure from unauthorised access. 2. Security is by default. Once CLAM has been set up the user does not have to take any positive action to secure data. 3. Access to all activities is via user defined menus within CLAM. 4. Each user is given a user name and password. These determine which menu options the user will see. Each user needs to remember only one password. 5. Even those with access to the DOS prompt can be limited to some (or no) subdirectories. 6. A complete audit trail of all use of the system is kept.

CLAM is available for most micros with PC/MS DOS version 2.0 or later: These include the IBM PC and all compatibles. CLAM costs £148 + VAT for a single user licence. Site and corporate licences are available. Existing MENUGEN users may upgrade to CLAM for £110 + VAT. CLAM may be purchased from MICROFT TECHNOLOGY LTD. The Old Powerhouse, Kew Gardens Station, Kew, Surrey TW9 3PS or from most dealers. To order or obtain further information telephone 01-948 8255.

CLAM

COMBINES THE FRIENDLIEST POSSIBLE 'FRONT END'
WITH COMPLETE SYSTEM SECURITY.

→ circle 149 on enquiry card ←

CLAM is a Trade Mark of Microft Technology Ltd and is a British product.

TOP 10

There is a wealth of information available from on-line data sources. **David Barlow** explains where to look for it, and how to find it.

More and more users in all manner of professions are finally beginning to realise the benefits that an appropriate on-line service has to offer. Undoubtedly this greater awareness has been given a tremendous boost by on-line services software and hardware that no longer demand any special computer expertise from the user.

High running costs, which currently average £50 per hour, must be seen as a major stumbling block to the average micro user, even though many of them already possess the necessary communications hardware and software. The costs do not end there, as on top has to be added the phone bill for ringing through to the host computer, plus a yearly subscription and often a joining fee too.

Because of the way on-line databases work, you end up dealing with two entirely different kinds of supplier, although their charges may well be presented to you in a single bill. Your direct contact will be with the host operator who runs the micro-computer or mainframe to which you connect with via the telephone system. It is the host computer organisations that are the

subject of this Top 10 survey. The host operator will usually charge you a joining fee to cover initial administration costs, and an annual subscription.

The databases stored on the host computers are prepared and updated by a publisher. Normally you will be charged for

every minute you have access to the information, though some databases allow a certain amount of free use or will grant unlimited access for an annual fee.

All hosts offer a selection of databases, so once you have joined you are not limited to just one source of information. Dialog is a classic case. Its list now extends to over 200 titles covering many aspects of professional life, including business, chemistry, medicine, law, science, news, energy, education, social sciences and people.

Choosing a suitable host can be a problem, as you may want one database available through host A and another available through host B. It is often possible to avoid paying two subscriptions as some of the more common databases are supplied by more than one host. By choosing your host operators carefully you may be able to keep your subscriptions down.

Using an on-line service seems complicated at first, but like most aspects of computing it gets a lot easier with familiarity. The trouble is that with charges running at up to £100 per hour, users are understandably reluctant to use the time-honoured trial-and-error method through

COMPUSERVE

COMPUSERVE boasts in excess of 350,000 subscribers worldwide for a comprehensive service that started back in 1979. Business coverage is excellent but there is much more to Compuserve than formal information. Its on-line databases include health and fitness, food and wine, and a shopping service. Although some of its services are rather trivial, they make for enlightening reading. Business interests are covered by such databases as AP Business News, Business Wire, Quick and Reilly, and Max Ule. The news database from Associated Press includes AP News and Sports Wire. Sports Forum, one of Compuserve's many on-line conference facilities, offers a place to talk to other supporters, players and professionals. Compuserve also runs on-line conferences, many of them with distinguished guest participants. Subscribing from the U.K. is not easy, but is well worth the effort as this is a lively service that contains much of interest to computer users.

COST: \$40 one-off subscription includes user guide, password and \$25 access-time credit; 300 baud access \$6 per hour off-peak, \$13 per hour peak time

DATABASES: commodities, news, standards and poors, financial forecasts, U.S. Today Update

DATASOLVE

THE MAINSTAY of Datasolve is World Reporter, which includes the full text of newspapers. Coverage goes back to 1985 for the FT, 1981 for the *Economist*, 1984 for the *Guardian*. Also available on-line is Tass, the official Soviet view of international news and current affairs. The BBC External Service news broadcasts are covered back to 1982. The Magic database gives you instant access to market sizes, brand leaders, media spending, press comment, and social and economic forecasts on most consumer goods in the U.K. The World Exporter database collects information about forthcoming projects, calls for tender, export contracts awarded, trade finance and currency movements. Datasolve is simple to use, and most searches can be accomplished with six command words.

COST: £60 per hour
DATABASES: World Reporter, now including *Business Week*, *Sunday Telegraph*, and *Daily Telegraph*, marketing and advertising, World Exporter, business intelligence

DATASTAR

DATASTAR offers a wide range of information sources, but its strengths are in business and medical areas. New databases are added frequently: it now

carries an Aids services published by the Bureau of Hygiene and Tropical Disease that includes critically evaluated records of important work on the virus drawn from over 1,100 journals worldwide. The BMAP database comprises summaries of articles in the media concerning key medical topics. Datastar includes Chemical Hazards in Industry (Chin), which gives coverage to published hazards along with Health and Safety information required by the bulk chemical industry. Datastar backs up its databases with personalised newsletters, a help desk and training courses.

COST: £60 per hour average use, £40 per hour medium use

DATABASES: company, market, industry, investment, biomedical, drug, chemical, technology

DIALOG

ALTHOUGH based in the U.S., the Dialog service is international and gives a PSS number to all U.K.-based subscribers. It runs at 300 baud or 1,200 baud and is backed by probably the most comprehensive set of literature currently available for an on-line service. It also offers the largest selection of databases covering all professions. It is hard to single out particular areas of strength, but business, science and education are the most notable. The business-software database includes descriptions of 3,000 business pack-

ages for minis and micro-computers with publishers' names and prices. Dialog's clear, printed price list details all the costs likely to be incurred with each database.

COST: \$25 per year, \$60 to \$80 per hour
DATABASES: Dun & Bradstreet, business data, medical, law, science, news, energy, education, social sciences

INFOSERVICE

INFOSERVICE contains details on share price movements both past and present. Users are charged on a per-price basis plus connect time. Data available includes commodities, stocks, options and bonds plus details on money markets and currency movements. Pricelink is of particular interest to micro users as it provides financial data in a form that can be loaded into a Lotus 1-2-3 or Symphony spreadsheet. Other spreadsheets can be used if they support data in ASCII or APL format. Infoservice Energy Data brings together all the reputable intelligence sources available, including Petroleum Argus, London Oil Reports, Lundberg, Petroleum Intelligence Weekly and Reuters.

COST: £52 per hour
DATABASES: OECD, IMF, Pricelink, aviation, Dow Jones, energy

which most of us have learned to use our machines. Because of this, it makes sense to consider one of the training courses that are offered by many hosts.

Generally speaking, U.S.-based host systems are far easier to use than their European equivalents. Lack of development, language problems and bureaucracy all conspire to make joining a European system a tedious business. Even when this hurdle is behind you, using the system can be made problematical by the absence of common communications protocols.

One way to keep both connect-time and access-time costs down is to use the fastest possible modem speed. Most services support both 300 baud and 1,200 baud. Although a higher charge is usually levied for using the higher speed it is invariably the most cost-effective solution. Another method of reducing connect-time costs is to join the Packet Switch Stream (PSS) network, the data-only system run by British Telecom. It lets you ring long distance at local rates plus a small PSS charge, and this service is more or less essential if you are going to access hosts in the U.S.

Finding out the details on databases avail-

DATABASE HOSTS

Compuserve 5000 Arlington Centre Boulevard, Columbia, Oh 43220, U.S.A. Telephone: (U.S. area code 614) 457-8600

Datasolve Datasolve House, 99 Staines Road West, Sunbury-on-Thames, Middlesex TW16 7AH. Telephone: (0932) 785566

Datastar Plaza Suite, 114 Jermyn Street, London SW1Y 6HJ. Telephone: 01-930 5503

Dialog PO Box 188, Oxford OX1 5AX. Telephone: (0865) 730275

Infoservice I P Sharp Associates, 10 Dean Farrar Street, London SW1H 0DX. Telephone: 01-222 7033

Mead Data Central International House, 1 St. Katharines Way, London E1 9UN. Telephone: 01-488 9187

Pergamon Infoline 12 Vandy Street, London EC2A 2DE. Telephone: 01-377 4650

Telecom Gold 60-68 St. Thomas Street, London SE1 3QU. Telephone: 01-403 6777

Textline Finsbury Data Services, 68/74 Carter Lane, London EC4V 5EA. Telephone: 01-248 9828

The Source 1616 Anderson Road, McLean, Va 22102, U.S.A. Telephone: (U.S. area code 703) 734-7500

able from each host is obviously a necessary preliminary to joining up. One method of going about this task is to contact all the hosts in our Top 10 and ask for a directory. If you already subscribe to Datastar the job can be done electronically by accessing a directory of databases called Cuadra. It contains descriptions of more than 2,400 publicly available on-line databases detailing name, type, content, language, geographic cover-

age, time span, and the all important frequency of updating.

For people who are not yet subscribers, *Information World Review* a monthly newspaper published by Learned Information Systems may prove useful. There is also a directory of British databases called *Britline*. It is published by Educational Data Information Ltd of Lingfield, Surrey, and costs £30 per issue.

MEAD DATA CENTRAL

U.S.-BASED Mead Data Central has a U.K. office and offers the incredibly comprehensive Nexis news service. Included in the list of publications on offer are such diverse examples as *Rolling Stone*, *Playboy* and *Working Woman*. All the heavyweights are of course covered, including the *FT*, *Washington Post* and *Economist*, but there is a definite bias towards U.S.-based sources throughout. Exchange includes company reports from leading investment-banking, brokerage and research organisations. Refsrv is a world-wide abstract and reference database including ABI/Inform, IAC and Biosis. Altogether Mead Data Central lays claim to the largest full-text database in the world.

COST: \$200 joining fee, \$100 per hour, depending on number of searches
DATABASES: Nexis, Lexpat, Exchange, medical

PERGAMON INFOLINE

INFOLINE is one of the fastest-growing on-line services. It offers access to a wide range of databases on business, patents, technology, health and safety, engineering and construction, many of them exclusive to Pergamon. Most of the databases available on Infoline are created and updated by

U.K.-based publishers and so are more relevant to British users than those offered by large U.S. organisations. There is no joining fee and you only pay for the time you are logged on to the system and the information you receive. Pergamon even allows you a certain amount of free time to get familiar with the way the system works. Working out how costs are running up is made easier by a clear and comprehensive printed price list.

COST: £60 per hour
DATABASES: Jordanwatch, Infocheck, Who Owns Whom, patents, legal, British standards

TELECOM GOLD

BEST known in its role as the leading U.K. electronic mail service, Telecom Gold also offers an increasingly wide range of on-line services to its subscribers. The Datasolve service is now available to Telecom Gold users through its mailbox, as is *Infomatics Daily Bulletin*, a newsletter for the computer industry. Also on offer are Infocheck, for information of financial status of companies, Jordanwatch, Jordansurvey, the Official Airline Guide, and Petroleum Monitor. The Fintech *Financial Times* technology supplements are also to be found on Gold. Today Telecom Gold has over 76,000 mailboxes in use, giving it a lot of clout in the on-line services mar-

ket. With an anticipated growth rate of 100 percent per annum its influence can only increase.

COST: £40 joining fee, £3.50 to £120 per hour
DATABASES: Jordanwatch, Jordansurvey, Datasolve, Petroleum Monitor, Infocheck, Official Airline Guide

TEXTLINE

THE Textline service offered by Finsbury Data includes a combination of full-text and abstracted articles from almost 1,000 newspapers, specialist magazines and press releases. They date back as far as January 1980. The topics covered include company, industrial, political and economic information worldwide. Newsline is a complementary database of extended headlines from the British, French, German and Swiss press. These headlines are replaced by the detailed abstracts on Textline a week or two later. Dataline is a database of annual financial accounts for 3,000 major manufacturing companies. There is a wide variety of contract types, depending on how the system is used.

COST: £50 joining fee; £70 per hour, or annual unlimited-access fee by negotiation

DATABASES: most European news media, specialist magazines worldwide, banking, insurance, chemicals, electronics and computing

THE SOURCE

THE SOURCE has become a household name in the U.S. because it carries all sorts of information. The Source directory lists all the services available, running to around 800 in all. The vast majority are small and extremely specialist, such as Ski Reports or Movie Reviews. Those geared to the business community are large, such as United Press International and Associated Press. The Source also has several special interest groups which at present cover such areas as the IBM PC, Macintosh, Apple II, law and science fiction. The Source used to be owned by Readers Digest, but it has recently been sold to a venture-capital organisation. Fortunately there is no suggestion that this change of ownership will alter the services offered to users.

COST: £49.95 joining fee; 300 baud peak rate, \$0.36 per minute at 300 baud, \$0.43 per minute at 1,200 baud peak rate
DATABASES: Associated Press, UPI, Business Update, Washington Post, share prices, news, weather, education

DAMSON COMPUTING

COMPUTERS, PRINTERS, PLOTTERS, PERIPHERALS,
SOFTWARE PACKAGES AND SUPPLIES

****We challenge you to beat these prices with written quotes****
New unbeatable prices on Sanyo 16 bit Business Computers
FOR AMSTRAD AND EPSON (01-803 7074 AND 01-807 7577
extension 42). Most competitive prices in the UK.

COMPUTERS
We supply Kaypro, Olivetti, Bondwell, Sanyo, Amstrad, BBC, Epson and Atari. Please Inquire about our best prices and excellent service on the PC range Special Offer: Free PC Del after 7pm in North and Central London areas.

Amstrad CPC6128, Green/col. £245/£335
Amstrad PC range. EPOA
Amstrad 8512 W/Prsr + Prnr + Scrn. £472
Amstrad PCW8256 Upgrade Kit. £164
Sanyo MBC 555/2 2X500K DRWS,
WS + CS + DS + MM + RdStar + Phillips Mon DOS2.11
£649
Sanyo MBC 885/IBM Compatible. £725
Sanyo MBC 555 2X160 + WS, CS, Infos. £225
Sanyo DM4112 12" Mono Monitor. £79
DAMSON SANYO SUPPLIER, ASK SANYO RANGE
Bondwell exelent PC compatibility. EPOA
BW34 640K RAM + 5 expansion slots, 4 unoccupied
in BAS machine + MS DOS 2.11 12" green screen +
IBM keyboard + Centri I/F £389
All above for only. £599
Bondwell true portable 3.5" 720K drive, 2nd drive
port, IBM compatible RGB + BAW rechargeable
battery + ext AC/DC. £745
BBC (Master) 128K. £389
Cumana disk drives SP offers. EPOA
Atari 5205TM. £208
Atari 520 STM + Mouse. £320
Atari 1040STEM + Mouse + M Mon. £569

NEW OFFER — SINCLAIR FROM ALAN SUGAR
AMIGA SYSTEM PLEASE ASK NOV SP OFFERS

PRINTERS
DOT MATRIX (Special offers)
Brother M1109 F/T P/S (New) NLO. £184
Brother M1509 F/T P/S 136c NLO. £383
Epson FX800. £310
Epson FX1000. £410
Epson LX86 120cps NLO. £199
Epson LX800 (P) 300cps. £395
Epson LQ800. £449
Epson H180 Plotter. £339
Juki 5510, 180cps, NLO, Colour optnl. £250
Canon A50 (NLO). £279
Canon A1 Laser Printer + cable. £1855
Canon Printer/Computer range. EPOA
Citizen 120D IBM/Epson F/T NLO. £158
Panasonic 1081. £169
MP165, 165cps (Various modes). £189
DAISYWHEEL (Special offers)
Juki 5100 Bi-d (Limited period). £249
Juki 2200 Typewriter/Printer. £215
Sanyo Memory Upgrade to 256K. £45
Sanyo disk drive upgrade 2 x 800KB. £245.
Amstrad PC now available. Please call for price.
Sage/IBM compatible s/w 15% discount.
Amstrad PC1512 DD, MM. £530
Amstrad PC, 20Mb, SD, CM. £1010

20MB HARD DISK UPGRADE FOR £325
30MB FOR £395
SAGE SOFTWARE 20% DISCOUNT
FOR OTHER SOFTWARE P.O.A.

MIRACLE TECHNOLOGY
WS4000 V21, V23, (V22). £130

Please add £6 + VAT per heavy item for parcel post (UK) delivery. £9 for next day delivery and £2 + VAT per item for ribbon and disk boxes. We advise, supply, install, maintain complete systems tailor made to customers specifications. All prices exclude VAT, are rounded to the nearest pound and are subject to change without notice.

Export, quantity and Official orders welcome.

(MAIL ORDER) 6 Rays Road, Edmonton,
London, N18 2NX. (Callers by appointment).

Easy to remember address, P.O. Box 100, London, N18 UK.
Phone 01-803 7074 and 01-807 7577 ext 42.
Telex: 8950511 ONEONE G, Telex Box No. 14514001.

→ circle 150 on enquiry card ←

THE INSTITUTION OF ANALYSTS & PROGRAMMERS



BUSINESS LEAFLET

The Council wishes to announce the preparation of a leaflet listing members' businesses which supply services relating to systems analysis and computer programming. The leaflet is intended for the many potential clients who request the Institution to recommend such services. Copies of the necessary data entry form have been posted to the known addresses of all members together with the 1987 Directory of Members and will be welcomed back as quickly as possible. Similarly, there is only a limited edition of the Directory which is already regarded as a valuable reference book so any member who has not received a copy (free to members, £17.50 including postage to non-members) is advised to inform the Records Department without delay.

The Institution of Analysts & Programmers is the principal association for professional systems analysts and computer programmers in the Free World. It is also the most highly regarded supplementary association for practising accountants, administrators, doctors, designers, engineers, lawyers, lecturers, mathematicians and scientists who use, develop and organise systems analysis and computer programming as a significant part of their professional undertakings.

A guide to the requirements and gradings of membership is available upon request to the Applications Officer either by letter or by telephone.

01-898 2385

The Institution of Analysts & Programmers
GIBSON HOUSE, FOURTH CROSS ROAD, TWICKENHAM
MIDDLESEX, TW2 5EL, ENGLAND

→ circle 151 on enquiry card ←

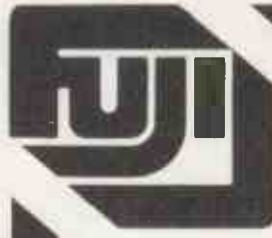

FLOPPY DISKS

All prices plus VAT

Free delivery

		PRICE EACH UNIT			
		CODE	10-40	50-90	100 +
8"	DS DD	FD2D	1.91	1.85	1.79
	SS DD	MD1D	1.02	0.98	0.95
	DS DD	MD2D	1.20	1.16	1.12
5 1/4"	DS 96TPI	MD2DD	1.43	1.39	1.34
	DS 1.6MGB	MD2HD	2.25	2.18	2.11
	SS 250K	MF1D	1.37	1.33	1.28
3 1/2"	DS 500K	MF2D	1.78	1.72	1.66
	SS 500K	MF1DD	1.78	1.72	1.66
	DS 1000K	MF2DD	2.18	2.11	2.04
NEW	DS 1.6MB	MD2HD	5.04	4.88	4.72

Polanka Video Limited

Unit X5 · Acton Business Centre
School Road · London NW10 6TD

01 965 4413

→ circle 152 on enquiry card ←

Forthright



NEW MODULAR FORTH

- * FORTH 83 in Modules
- * MULTI-TASKING
- * Floating Point and many more features
- * AWARD WINNING

£475 + VAT

NEW

FORTH 83 FOR ATARI ST

- * WITH COMPLETE GRAPHICS

£65 + VAT

AND

Our dependable Work-Forth

- * Takes the hard work out of Forth.

£55 + VAT

Extras: Floating Point
Source — Level De-bugger

£35 each + VAT

Forth plus Cross Compilation

Forth allows

- * rapid and interactive software development
- * full control of hardware
- * high speed and compactness

Cross Compilation allows Debugged Forth application on development OS to be ported and ROMmed into target system

Host systems
CPM80, CPM68K, MSDOS, PCDOS, FLEX, OS9, VMS, RSX11M.

£250 per core (buy only once)

Targets

Z80, 8080/5, 8086/8, 8070, Z8, 6502, 6511Q, 1802, 6800, 6801 — 6303, 6809, 68000, 99xxx, PDP11.

£175 per target
8031/15 Target £350

For further information, contact

Micro Processor Engineering Ltd

133 Hill Lane,
Shirley, Southampton SO15 9AP
Tel: 0703 631441



→ circle 153 on enquiry card ←

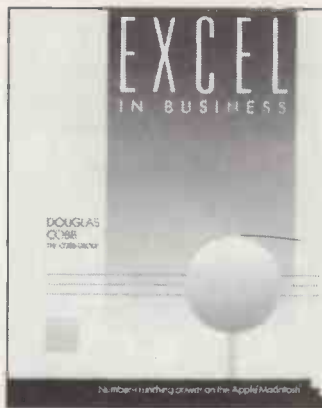

SPREADSHEET

EXCEL IN BUSINESS

By Douglas Cobb • Published by Microsoft Press; distributed through Penguin £19.95 • ISBN 0 914845 61 6

THE Microsoft Press is building up an enviable reputation for definitive high-quality books. Its fat paperbacks show up the previous years' computer books for the unsatisfactory productions they were. *Excel in Business* is no exception.

It is written by a co-author of *Using 1-2-3*, of which some 450,000 copies have been sold. This gives Cobb a good sense of context. And as he points out, Microsoft's Excel for the Mac is in most respects superior to the Lotus product. Following the announcement of OS/2, and the central importance of Windows to it, it is likely that the PC version of Excel will have a significant impact on 1-2-3.

The text proceeds straightforwardly with a look at the basic spreadsheet elements, followed by four chapters on graphics, three on database functions and three on macros. There is an appendix on transferring data and using the Switcher utility, followed by a good index.

The text is very well written, and the layout admirably clear. There are screen dumps and printouts on practically every page. Nice touches include tips and even the odd wish as to what the next version of Excel should contain. Recommended. **GM**

DATA TRANSFER

FILE FORMATS FOR POPULAR PC SOFTWARE

By Jeff Walden • Published by Wiley Press £20.50 • ISBN 0 471 83671 0

FOR the corporate user in particular, it is important to be able to trade information between different packages. But facilities for this are often missing, or they may not work exactly as required.

This book gives you the information necessary to start doing something about the problem.

Over a dozen of the most popular formats are covered: Lotus 1-2-3, Symphony, dBase II and III, Multimate, WordStar, WordStar 2000, Supercalc 3, VisiCalc, Multiplan and Syk, Ability, IBM Plans+ and DIF. Much of the information has been provided by the publishers of the packages themselves, but in some cases the author, Jeff Walden, has had to supplement it with detective work of his own.

Presentation and layout are good, with diagrams where they are needed. The book is 287 pages long, and often extremely detailed. But it still manages to be written in clear English, and never degenerates into an impersonal or poorly explained dump of undigested fact.

For each product family Walden first gives a general overview of the file structure and then systematically goes through the format. Key parts of the description often proceed on a byte-by-byte basis, with several paragraphs sometimes necessary to delineate the functions of a single byte.

In addition to this narrative description in the main part of the book, annotated sample files for most of the packages are provided at the back. As far as possible, the same sample data is used for each

package. For the word processors it is two paragraphs from the Gettysburg address; for the spreadsheets it is the same sample model. This is useful if you want to compare the way different packages do things.

File Formats is not the kind of book anyone is likely to sit down and read at a single sitting. In fact, much of the information in it is probably over the heads of many users. Nevertheless it is exactly the sort of thing you need when things go wrong with a file transfer, or if you are forced to create your own facilities. Even if you lack the expertise to fix things yourself, *File Formats* will give you some understanding of what is involved before you go to a specialist.

Certainly, any organisation that uses a variety of different PC software packages should find it worthwhile having a copy of *File Formats* on the shelf. **IS**

DTP

DESKTOP PUBLISHING: USING PAGEMAKER ON THE APPLE MACINTOSH

By Andrew Lucas • Published by Ellis Horwood • £22.50 hardback, £14.95 paperback • ISBN 0 7458 0169 2 hardback, 0 7458 0203 6 paperback

AS desk-top publishing (DTP) becomes more and more fashionable, so a flood of books on the subject seems imminent. One of the first

AMSTRAD PC

Introducing the Amstrad PC By Peter Rodwell, £7.95 • **Using Gem on the Amstrad PC** By Kathy Lang £12.95 • **Business Presentation on the Amstrad PC** By Kathy Lang £12.95 • **Word processing using Gem Write on the Amstrad PC** By Mike O'Reilly £9.95 • **Using DOS Plus on the Amstrad PC** By Stephen Marris £9.95 • PUBLISHED BY GLENTOP PUBLISHERS

ONE OF the less happy trends of recent years has been the appearance of books to accompany the launch of new micros. Some of them appear almost immediately, casting some doubt on the thoroughness of the work which has gone into putting them together. Since the only way books can be written to such schedules is for the publisher to work closely with the manufacturer, there is also the problem of objectivity. This series of books from Glentop is a case in point. There is the added complication that three of them appear under the imprint of Digital Research Books.

The introductory title from Peter Rodwell does not augur well. It suffers from a lack of subediting which makes the ride rather bumpy for the reader. Its content is not much better: over half the book is devoted to an examination of Gem that is too general to be helpful. Far better is *Using Gem* by Kathy Lang, which concentrates on this area, though again it spreads itself a little thinly in trying to cover all the Gem applications.

Business Presentation Graphics from the same author is probably the best of the lot because it has a sufficiently narrow scope. There are some useful tips on the mechanics of giving talks and suchlike. By contrast, the books on Gem Write and DOS Plus are pretty useless, for the simple reason that the software they focus on is by now of rather marginal interest. Another fault of both these books is the wholesale borrowing of Rodwell's introductory chapter, which does even less here than in its original context. Lang's two books also share some text, but at least it has been reworked, though not sufficiently to justify the steep prices affecting all these books. **GM**

BOOK REVIEWS

past the post is Andrew Lucas's *Desktop Publishing*. Lucas is marketing manager of Prospero Software, but what seems to qualify him to write about DTP is his enthusiasm and experiences as a user.

The book is divided into three parts: an introduction to DTP, an illustrated section on Pagemaker and a final section on other necessary software, including the Finder, Macpaint and Macwrite. The introduction relates what DTP is, plus how and why you should use it. For someone coming across DTP for the first time this should prove useful.

The section on hardware explains what you will need for DTP with the Mac, and the advantages of the Mac and a laser printer for DTP. It even bothers to explain why you may need the help of a graphic designer. The consequences of DTP for the jobs of printers and typesetters are also covered.

The piece on Pagemaker itself is packed with screen dumps as the author gives a step-by-step explanation on how to put together a page. Finally, the chapters on other software are handy, especially for a beginner, providing a brief insight into how to use, say, Macpaint with particular reference to Pagemaker.

Desktop Publishing is a useful reference book for anyone thinking of using Pagemaker on the Mac. It combines a lot of relevant information in one book rather than having it scattered around in several manuals. The author also manages to explain things clearly to the beginner, but at the same time gives technical details and provides a lot of useful advice.

If the book covers what you want it is certainly worth a look. The only problem is that many of the specifics may soon become dated as new software and improved hardware appear. In one sense it is obsolescent already insofar as it omits to mention the Mac II and Mac SE. **CH**

(continued on next page)

BOOK

REVIEWS

(continued from previous page)

PCs FOR BEGINNERS

POWER PACK FOR THE IBM PC

By P Dravillas, S Stilwell and B Williams • Published by Blackwell Scientific £23.50 • ISBN 0 8016 1451 1

THE advent of the Amstrad PC has bought with it a whiff of the heady days of 1983/4 when the home-computer boom was at its height. The emerging new user base is perceived as knowing little of the hardware it is buying, and there are a host of people who are willing to take innocents in hand — for a price.

The computer book industry has accordingly produced a surge of tomes on the lines of "How to Use

Your Amstrad/Gem/MS-DOS". Thankfully, their quality has improved since the days of the home computer, and one of the better books to emerge over the past six months is *Power Pack for the IBM PC*.

The declared intention of the book is to give the beginner a complete grounding in business computing and to provide a basic familiarity with the major applications. To help you along, the book comes with two discs containing a suite of basic word-processing, spreadsheet and database programs.

It starts with an explanation of terms such as "operating system" and "floppy-disc drives", though surely the majority of people who buy a PC clone will know what a floppy disc is. Nevertheless the book is clear and well written, and provides an excellent primer for those who know little or nothing about their machine.

The same goes for application tutorials. Each one is clearly explained with reference to the programs provided on disc. The program themselves are hardly state-of-the-art, but they are not toys or mere education tools either — they actually work. Highly recommended for the absolute beginner.

NETWORKS

DATA COMMUNICATIONS AND LAN TECHNOLOGY

By Ed da Silva • Published by Collins £14.95 • ISBN 0 00 383230 9

THERE is probably no area of computing which has so much misunderstanding surrounding it as that of networking. Any book which purports to throw some light on to the subject is therefore to be welcomed.

Ed da Silva is a lecturer in networks for the Open University and should be skilled in taking novices through a complicated and difficult subject. At the beginning da Silva promises that no technical knowledge is required and that the book is filled with examples from "our daily lives".

But after a while the technical tables begin to appear, and I began to feel that anyone not concentrating hard would lose the thread of the argument. All the same the book is a thorough explanation of networking, even if the general-interest reader may not be particularly intrigued by the pin-outs on an RS-232 socket.

Although the book was published in 1986, it already seems

Introduction to Data Communications and LAN Technology



Ed da Silva

somewhat out of date. It is not just the references to the BBC Micro and the Osborne 1, or even the fact that token passing is disposed of in two pages while there are innumerable references to the older X-21, RS-232 and Ethernet technologies. Rather it is the overall flavour that is at fault. The book appears to be aimed at the home hobbyist, complete with soldering iron, and the computer-science teacher. It could well be ideal for these groups, but the needs of a business-orientated audience are not addressed. SM

Reviewers this month: Carol Hammond, Steve Malone, Glyn Moody, Ian Stobie. 

Oasis Products

OASIS VIRTUAL INSTRUMENT SYSTEM

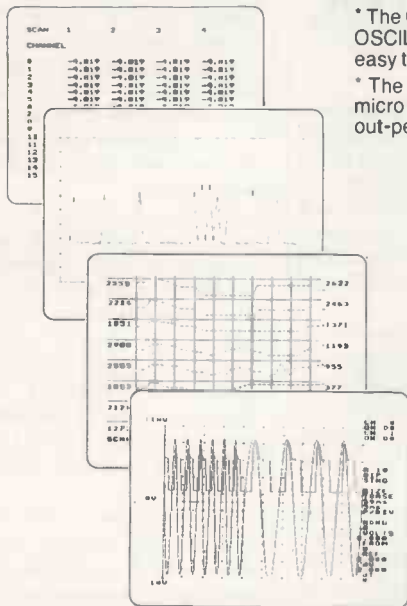

* The OASIS Virtual Instrument System (VIS) emulates conventional DVM, OSCILLOSCOPE, CHART RECORDER, X/Y PLOTTER and DATA LOGGER in one easy to use package and also provides sophisticated data analysis tools.

* The VIS data acquisition module and instrument emulation software turns the BBC micro directly into a versatile and flexible laboratory measurement system which can out-perform and is easier to implement than IEEE 488 linked systems.

* VIS professional, ready-to-use instrument emulations include: Multi-channel DVM with real time numeric and graphic displays, storage SCOPE with on-screen measurement and waveform zoom, DATA LOGGER with logged data compression algorithm and X/Y PLOTTER with programmable integration periods.

HARDWARE

VIS is based on a precision computer controlled 16 channel A-D converter, with six programmable ranges and read rates of 50k samples per second at 8 bit resolution, 25k at 12 bit.

This simply installed unit has proven long term stability and reliability.

SOFTWARE

The menu-driven acquisition, analysis and display programs combine on screen set up of measurement parameters, SPREADSHEET data manipulation and a range of data display formats, including 8 trace CHART RECORDER and oscillogram.

Total data mobility from measured information to memory, disk, screen and HARD COPY output.

The OASIS VIS carries full documentation to allow the beginner or professional programmer to create new interface applications or personalised instrument emulations.

PRICE

At £399 (ex VAT), the price of the complete VIS system is less than any one of the instruments it replaces. Performance enhanced versions also available, e.g. higher acquisition speeds.

For fast delivery, phone your order on 0603 747887. Technical queries answered and requests for further data on this number.

The Street, Old Costessey, Norwich NR8 5DF. Tel: 0603 747887

Design Consultancy

AT PORTABLE COMPUTER

20 Megabyte Hard Disk
3 Speed 80286. High Res Monitor
Tough and Light.
Complete with standard expansion slots
12 months warranty
Only £1199.00 Plus VAT.

NATIONAL PANASONIC KXP1081 PRINTER

£195.00 Plus VAT

MICROLEDGER II INTEGRATED ACCOUNTS SOFTWARE

Sales, Purchase and Nominal Ledgers
Written by Accountants
Multi-User Suitable for most Decent Computers
£99.00 Plus VAT
With Stock Control/Invoicer
£145.00 Plus VAT
Demo Disk £10.00 Plus VAT
VHS Video Training Cassette £15.00
Available in English/Arabic and other Major Languages

CASH WITH ORDER PLEASE

All Major Credit Cards Accepted UK and Internationally
Export Welcomed
Purchase Orders Accepted from PLC Cos. Government/Schools

From Data Marketing Limited,
18 Cardiff Road, Luton, Beds LU1 1PP
Tel: (0582) 458806. Telex: 94016469 (Mill G)
Link MBX 19011700

→ circle 155 on enquiry card ←

System Science

Programming and system support software

AZTECC

For the IBM-PC MS-DOS, Apple IIe, Macintosh and Amiga. Cross compilers for 8080, 8086, 6502, 68000 processors. Includes the compiler, assembler and overlay linker. COMMERCIAL versions also include library sources and ROM support plus development tools.

DE-SMET C

For Apricot and PCs, this fast small model compiler includes an assembler, screen editor and linker with overlay and 8087 support.

PHOENIX PRODUCTS

PMATE — the programmable programmers editor.
PLINK-86 — fast versatile overlay linker.
PLINK-86 Plus — more features, overlay caching.
Pre-C — C syntax checker or LINT utility.
PforC — the C source library with everything — screens, windowing, database and system functions.
PFix 86 Plus — Symbolic Debugger

FORTRAN

Fortran-77 compilers for MS-DOS and PC-DOS are available from Microsoft Ryan-McFarland and Prospero. All support large memory models and 8087 processor. Add-on libraries are available for graphics, maths and scientific functions and database functions. We also stock Fortran compilers for CP/M-80

BORLAND'S TURBO

We stock the complete range of Turbo Pascal products plus add-on products as well as Sidekick, Superkey and the NEW Turbo PROLOG.

LATTICE C

The LATTICE C Compiler, the programmers compiler, with a wide range of applications libraries. Included are four memory models and 8087 support, also from LATTICE the C SPRITE debugger, DB-IIC and DB-IIC libraries, Lattice Make utility and Screen Editor.

MICROSOFT C

Supports all Intel memory models with 8087 support and overlay linker. Symmetric to the Microsoft XENIX C Compiler. Now includes the Codeview Debugger.

C LIBRARIES

Add-on libraries are available for C for a variety of applications. Check compiler compatibility when ordering GREEN LEAF COMMUNICATIONS and GENERAL functions, C-TREE, C-ISAM and B-TREVE for database functions, PANEL and WINDOWS for DATA for screen entry, MULTI-HALO, GRAPHICS for C, Essential Graphics for graphics and many more including real-time sorts etc.

ASSEMBLER

8086 Macro Ass. from Microsoft and from 2500AD Software for MS-DOS. MACRO-80 and 2500AD's 280 Macro for CP/M-80.
CROSS ASSEMBLERS (Macros, relocatable with linker) available for MS-DOS an CP/M-80. Targets include 280, 8086, 68000, 6800, 6809, 6301, 6502, 8051, 8048 etc.

VENTURE-Desktop Publishing

For the IBM PC and AT, with support for Postscript, HP Laser Jet and other output devices. Fonts, graphics, layout etc.

A sample of our range of useful products for the programmer.

6-7 West Smithfield, London EC1A 9JX, Tel: 01-248 0962

→ circle 156 on enquiry card ←

FREE OVERNIGHT DELIVERY*

01-455 9823

COMPUTERS/CALCULATORS/PLOTTERS

LASER PRINTERS			
CANON LBP8.....	£1835.00	HP 18C (BUSINESS CAL).....	£160.00
BDS (CANON COMPATIBLE).....	£2197.00	HP 28C (SCI PRO CAL).....	£200.00
QUME LASER TEN.....	£2285.00	HP7440 (A4 2 PEN PLOTTER).....	£860.00
NECLC08.....	£2399.00	HP745A (A3 8 PEN PLOTTER).....	£1499.00
HP LASER PLUS.....	EPA	HP7550 (8 PEN A4/A3).....	£3220.00
HP LASER JET.....	£1750.00	HP7580B (A1).....	£7500.00
HP THINK JET.....	£435.00	ROLAND 980 (A3/8 PEN).....	£1075.00
RICOH LP 4081-RI (WITH HP LASER		TAXAN 710 (A3/6 PEN).....	£895.00
+ EMULTION.....	£2999.00	SHARP PC 1500A.....	£147.00
AST TURBO-LASER.....	£3550.00	PC1600 (16K).....	£1950.00
KI LASERLINE.....	£1750.00	EPSON PC AX WITH 20MB H/D.....	£1950.00
OLIVETTI M24.....	EPA	AMSTRAD 8512 PC/1512	
EPSON PC 256K + 2 x 360K/D.....	£650.00	(MONO/COLOUR/DISK 10/20	
EPSON PC 256K + 360K/D +		MB/HD.....	FROM £449.00
20MB H/D.....	£999.00	BUDGET DELTA 4/ABC BUSINESS SYSTEM	
EPSON PC + 640K + 2 x		STOCKED	
360K/D.....	EPA	AMSTRAD SOFTWARE SAGE	
HP41 CV COMPUTER.....	£139.00		
HP41 CX COMPUTER.....	£199.00		

MONITORS/PRINTERS

MICROLINE 182 (120CPS).....	£193.50	TAXAN — PRINTERS AND PLOTTER RANGE	
MICROLINE 192 (160CPS).....	£207.50	EPSON COMPLETE RANGE IN STOCK	
MICROLINE 84 T/F (200CPS/NLQ).....	£620.00	LX86 (120CPS).....	£210.00
OKI 294 (400CPS).....	£770.00	LQ1000 67K BUFFER (180CPS).....	£643.00
OKI COMPLETE RANGE IN STOCK		LQ800 (60 180CPS).....	£470.00
NEC P7.....	£465.00	LQ2500.....	£787.00
NEC P7.....	£465.00	EX8000.....	£439.00
NEC P5.....	£750.00	EX1000.....	£559.00
NEC COMPLETE RANGE IN STOCK		SO2500 (NEW).....	EPA
DISK DRIVES/TAPE STREAMERS POA		BROTHER HR20.....	£333.00
DISC DRIVES TAPE STREAMERS.....	POA	HR25 (3K BUFFER 25CPS).....	£549.00
QUME 12/20.....	£410.00	H35 (35CPS).....	£720.00
QUME 12/45 SPRINT (S/P).....	£599.00	20241 (190CPS/NLQ).....	£690.00
QUME 1190 (90 CPS).....	£1255.00	1709 (240CPS).....	£456.00
QUME COMPLETE IN RANGE IN STOCK			
STAR NB15 (136COL/300CPS).....	£760.00		

BUFFERS/IN-LINE 1256K/512MG AUTO-SWITCHES/BIDIRECTIONAL CONVERTERS

MONITOR/TERMINALS

ZENITH.....	FROM £425.00
TELEVIDEO.....	FROM £280.00
WYSE.....	FROM £360.00
QUME.....	FROM £360.00
HAZELTINE/SPRIT.....	FROM £425.00
TAXAN/PHILIPS/ZENITH.....	FROM £65.00
NEC MULTISYNC COLOUR IN STOCK	

CAN YOU FIND A LOWER PRICE PHONE US FOR BEST DEAL

SOFTWARE

IBM/COMPAQ/OLIVETTI/AMSTRAD		SMART WORD PROC.....	£220.00
LOTUS 1-2-3.....	£222.00	DATA MANAGER.....	£299.00
SYMPHONY.....	£339.00	MICROSOFT PROJECT.....	£275.00
D/BASE II.....	£222.00	SUPERCALC 4.....	£238.00
GRAPHWRITER COMBO PAK.....	£339.00	TURBO CAD.....	£330.00
CHARTMASTER.....	£295.00	WORDSTAR 2000.....	£215.00
MAP MASTER.....	£285.00	WORDSTAR PROF 4.0.....	£267.00
PSF PROF WRITE.....	£169.00	MULTIMATE.....	£267.00
PSF PROF FILE.....	£229.00	QUICKCODE III.....	£179.00
PSF PROF PLAN.....	£250.00	SAGE CHIT-CHAT.....	FROM £76.00
FREELASE +.....	£350.00	SAGE ACCOUNTS.....	FROM £85.00
FRAMEWORK II.....	£335.00	CROSSTALK.....	£120.00
D/BASE III PLUS.....	£335.00	GEM PAINT/WRITE.....	£125.00
D/BASE CLIPPER.....	£399.00	BORLAND TURBO RANGE.....	FROM £22.00
JAVELIN.....	£70A	JENIFER.....	£275.00
R BASE 5000.....	£220.00	SANNA PLUS.....	£498.00
EASY FILLER.....	£199.00	MULTIMATE ADVANTAGE.....	£295.00
TRAINING LOTUS 1-2-3.....	£66.00	ORMIS 3D/BASE.....	£295.00
LOGISTIX.....	£90.00	LATTICE C COMPILER.....	£245.00
HERCULES GRAPHIC CARD PLUS.....	£195.00	DELTA PROFESSIONAL.....	£333
FORMATTING AVAILABLE		REFLEX-WORKSHOP.....	£63
HARVARD PRESENTATION		SAGE RETRIEVE.....	£71
GRAPHICS.....	£250.00	VP INFO.....	£62
MS WINDOWS.....	£75.00	LOTUS MANUSCRIPT.....	£269
COBOL COMPILER.....	£495.00	VENTURA-DESKTOP PUBL.....	£769
PASCAL COMPILER.....	£190.00	WORDSTAR 2000+.....	£269
FORTRAN COMPILER.....	£220.00	WORDSTAR PROFESSIONAL.....	£193
VOLKSWRITER 3.....	£169.00	MULTIPLAN.....	£109
MICRO SOFT MOUSE/WINDOWS.....	£199.00	VP PLANNER.....	£61
MICROSOFT WORD 3.1.....	£310.00	PARADOX VER 1.1.....	£377
LOTUS HALO.....	£115.00	QUICK BASIC COMPILER.....	£75
FUNK SIDEWAYS 3.1.....	£68.00	EXCEL (MICROSOFT) FOR MAC.....	£345
HARVARD TOTAL 2.....	£399.00		
R BASE SYSTEMS 5.....	£499.00		
(SELECTION OF EXTENSIVE RANGE)			
OPEN ACCESS II.....	£575.00		
OPEN ACCESS.....	£285.00		
SMART SYSTEM.....	£399.00		
SMART SPREADSHEET.....	£299.00		

IBM COMPATIBLE EXPANSION PRODUCTS AST/PERSYST/EVEREX/TC/MAR/GENOA/OMEGA/QUADRAM/ORCHID/PARADISE

GOODS FULLY GUARANTEED. PRICES EXCLUDING VAT (P&P EXTRA ON ORDERS UNDER £300).

Company and Government orders accepted by telephone.
Barclaycard Access Visa accepted by phone.

Tel: 01-455 9823
MOUNTAINDENE

22 Cowper Street, London EC2

→ circle 157 on enquiry card ←

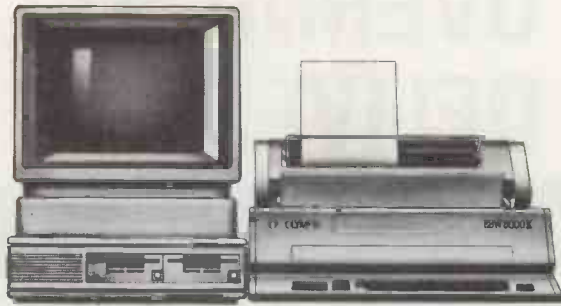

HEWLETT PACKARD.

OLYMPIA.

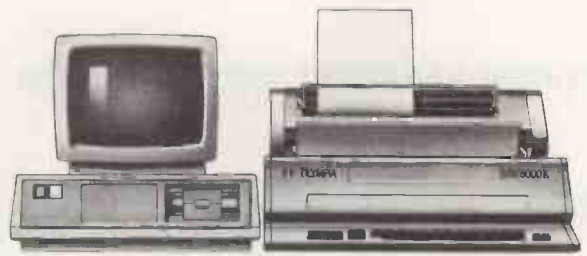

DEC RAINBOW.

OLYMPIA.

We even make a product for our competitors.

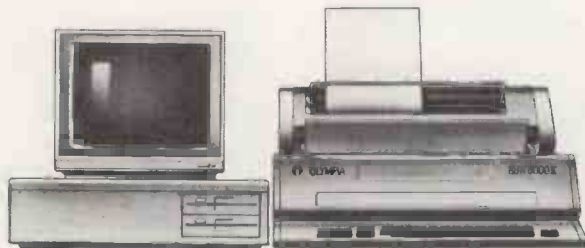

COMMODORE.

OLYMPIA.

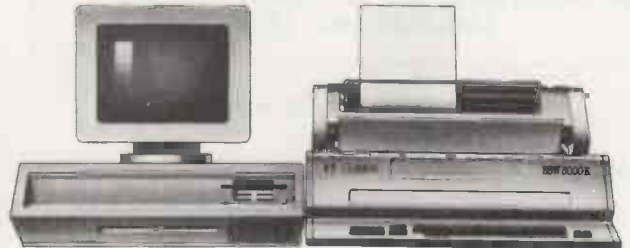

ACT APRICOT.

OLYMPIA.

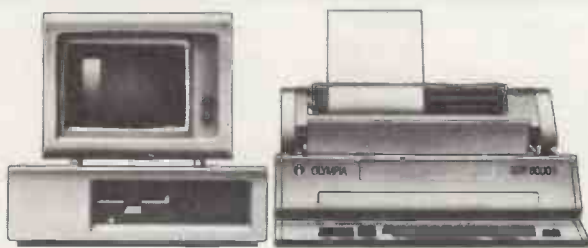

IBM PC.

OLYMPIA.

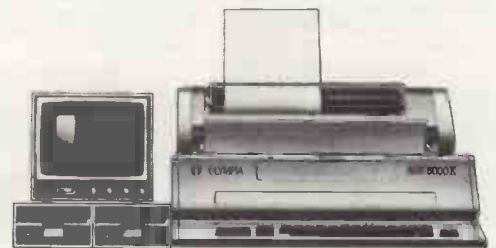

APPLE.

OLYMPIA.

Our daisywheel printers do a very fine job when linked up to our microcomputers.

And they perform equally well when they're next to somebody else's.

We make three printers in all.

The ESW 3000K and ESW 103 have their own keyboards.

So when they're not printing they can be used as typewriters. Unlike other printers that would stand idle. Both possess 4k print buffers and KSR capability.

And both produce letter quality type quicker than a turbo-charged typist. Up to 50

characters per second with the ESW 3000K.

Our third model is the compact RO printer. A neat little workhorse with a built-in tractor feed.

All three printers are as reliable as the weather. (You can rely on there being weather every day.)

For free colour brochures of our complete range of printers send off the coupon now.

You'll see, whatever make of micro-computer you own, we'll bring the best out of it.

Send to Penny Cottee, Olympia Business Machines, FREEPOST, 199/205 Old Marylebone Road, London NW1 1YB.
NO STAMP REQUIRED.
Please send me your FREE full colour Printers brochures.



Name _____

Address _____

Postcode: _____ Tel. No. _____

OLYMPIA

→ circle 158 on enquiry card ←

PROMPTED DELETE

Jim Bates presents an MS-DOS utility which displays a directory listing from which you can choose the files you want to delete.

FROM time to time, it becomes necessary to delete unwanted files from a disc in order to keep things tidy and to make maximum use of available disc space. This process is easy when deleting a set of files with some common factor in their file name — like all the Bak files created by some word-processing programs, for example. However, when there is no common factor, the process can become quite a chore. You have to produce a directory listing of all the files, and then delete those you do not want one by one.

This program should make the process a little easier. It will display each file name that matches the name given on the command line and asks if you want to delete it. If you answer Y the file is deleted; answer N and the next file name is displayed. To abort the program before all file names have been displayed you hit Escape.

Unlike last month's utility, this program does not remain resident in memory. It should be used from the operating-system prompt, like Format or Diskcopy, and it will be overwritten by the next program that is loaded. It includes a message to prompt the operator on correct usage if the original command is incorrect.

A data listing of the program is provided as well as a full assembler listing. If you would like to use the program but don't have access to an assembler just enter the relevant data using the Basic Loader program from last month's article.

This program introduces several interrupt functions that have not been used before in this series, as well as showing how details from the command line and command tail can be examined within an assembly-language program. The command line is the line on the screen where the originating command is entered. For example, when you enter a command like

DIR *.DAT/W

Dir is the actual command, and *.Dat/W is called the Command Tail.

The first section of the assembler program in listing 1 sets up equates which identify the Esc, CR and LF characters and the locations of the file control block and the command tail. When a Com file is loaded into memory by the MS-DOS operating system, a 256-byte area called the program segment prefix (PSP) is created at address 0. The actual program is loaded into location 100hex onwards. This is why the

ORG 100H

statement is required for assembly of Com file programs.

The PSP contains lots of information that the operating system

requires during and after the running of a Com file. Two locations within this area to be accessed are the state of the file control block (FCB) at 5Chex and the start of the command tail at 80hex. Setting equates in this way helps to make the assembly program easier to read since an instruction like

MOV SI,80H

tells us little, while

MOV SI, TAIL

shows that you are accessing the Tail area through the source index register. Both versions will produce the same code after assembly.

Immediately after the equates come the initial instructions for the assembler: Segment and Origin (ORG) statements along with the segment assumptions. To keep these programs simple, I have avoided using segment registers

wherever possible and relied upon the MS-DOS default, which ensures that all segment registers are set to point into the code segment when a Com file is loaded.

The actual code of the program starts at label Start. The first instruction is a jump over the message area to the program instructions which start at label Begin. Messages and data areas can be located anywhere in a program, but by placing them before the bulk of the program code, the assembler's job is made much easier and some potentially difficult errors can be avoided.

The message area lists all the messages that may need to be displayed during the program. Since function 9 of Interrupt 21hex will be used to display them, each one must end with the \$ sign.

Carriage Returns and Linefeeds within the messages are clearly marked as CR and LF.

The first instruction at Begin loads the effective address of MSGO into DX. In this context, the effective address is the location at the start of the MSGO text. We then use function 9 of Interrupt 21hex to display it. This function takes the message starting at the location pointed to by the DS:DX combination of registers, and displays it at the current cursor position on the screen.

Since all the messages are in the code segment, and the DS register is set to point to the code segment when any Com file is loaded, it is necessary only to set DX to point to the message to be shown on the screen. Function 9 will display any characters that you like, up to but not including the \$ sign. So once the function number is moved into AH and Interrupt 21hex is called — just like a subroutine — MSGO will appear on the screen. This message will occupy two lines because of the embedded Carriage Return and Linefeed characters. The final CR and LF characters will position the cursor ready for the next message.

(continued on next page)

LISTING 1. FILE DELETE

COMMENT *

This program is designed to selectively DELETE files which match the specified filespec in the current directory of the default drive.

If no files are specified, then the program will prompt the user on correct usage.

*

```

;=====
;          EQUATES
;=====
    
```

```

CR      EQU    13      ; Carriage Return Character
LF      EQU    10      ; Line Feed Character
ESC     EQU    27      ; Escape Character
FCB     EQU    5CH     ; Location of File Control Block
TAIL    EQU    80H     ; Location of Command Tail Area
    
```

```

;=====
    
```

```

CODE    SEGMENT

        ORG    100H      ; MUST BE 100H FOR .COM FILE

        ASSUME CS:CODE, DS:CODE

START:  JMP    BEGIN    ; Jump over messages
    
```

(listing continued on next page)

■ U T I L I T I E S ■

(continued from previous page)

The next task is to check that a command tail was entered. This is done by examining the contents of the byte at location 80hex in the PSP. MS-DOS stores the command tail at locations 81hex onwards, and puts a number indicating the number of characters in the Tail into location 80hex. The program checks this number to make sure that it is larger than zero. If it is, then processing continues at the Continue Label. If it is not, then no command tail was entered and MSG4 is displayed to prompt the operator on how to use the program.

At Continue the program accesses the file control block (FCB). This is an area created by MS-DOS which contains the command tail in file-name form. The program makes no attempt to check the validity of the command tail; later functions will reject any invalid file names, so there should be no problems. Having pointed the DX register to the FCB the program can call function 11hex of Interrupt 21hex. This function will attempt to find the first file name in the current directory that matches the command tail. The matching of file names with this function also includes the use of the wild-card characters ? and *.

If a matching file name is found, the AL register is returned containing zero; otherwise AL contains 0FFhex. This register is tested to check whether a file was found, and if not the No Matching Files Found message MSG3 is displayed and we quit the program. If a file was found its full name will have been placed in the command tail area, preceded by one byte which indicates the relevant drive.

Processing passes to the label Search to print the Delete message MSG1. This message has a Carriage Return and Linefeed before it and three spaces after it. Thus the cursor is moved to the beginning of the next line before displaying, and it will remain on the same line as the word Delete after display. The name of the file that has been found is displayed using a different function of Interrupt 21hex.

The BX register is used for the location of the byte that is to be displayed. The address of the command tail area, plus the one byte where the drive identifier is stored, is moved into BX and the function number is put into AH. The file name is actually stored as 11 characters: eight for the file name itself and three for the extension. Spaces are used to pad out the area.

Before calling the interrupt to

FILE DELETE

(listing continued from previous page)

```

;=====
;                               MESSAGE Area
;=====
MSG0   DB      'BATES Associates',CR,LF
        DB      'Multiple File Deletion Version 1.20',CR,LF,'$'
MSG1   DB      CR,LF,'DELETE  $'
MSG2   DB      '(Y/N)? $'
MSG3   DB      'No Matching Files Found',CR,LF,'$'
MSG4   DB      'Please use DLT like the DIR command'
        DB      ' eg: DLT *.BAK',CR,LF,'$'

;=====
;                               PROGRAM CODE
;=====

BEGIN:
        LEA     DX,MSG0           ; Sign-on Message
        MOV     AH,9              ; Function Call
        INT     21H              ; Print Message
        MOV     SI,TAIL          ; Check for filename entered
        MOV     AL,[SI]         ; Get number of characters
        CMP     AL,1
        JGE     CONTINUE        ; More than 1 letter so continue
        LEA     DX,MSG4         ; Prompt user on usage
        MOV     AH,9
        INT     21H
        JMP     QUIT            ; Exit to DOS

;-----

CONTINUE:
        MOV     DX,FCB           ; Address the P.S.P. FCB
        MOV     AH,11H          ; Function Call
        INT     21H            ; Find first Match
        CMP     AL,0           ; Found it?
        JZ      SEARCH         ; Yes - so continue
        LEA     DX,MSG3        ; No files Message
        MOV     AH,9
        INT     21H            ; Print Message
        INT     20H            ; End program

;-----

SEARCH:
        LEA     DX,MSG1        ; DELETION Prompt message
        MOV     AH,9
        INT     21H            ; Print Message
        MOV     BX,TAIL+1      ; FCB in TAIL from last find
        MOV     AH,2
        MOV     CX,0BH         ; 11 characters to display

PRT_LOOP:
        MOV     DL,[BX]        ; Get a character into DL
        INC     BX             ; Bump the Pointer
        INT     21H            ; Display Character
        LOOP   PRT_LOOP       ; Go Again
        LEA     DX,MSG2        ; Display the (Y/N)? prompt
        MOV     AH,9
        INT     21H            ; Print Message

GET_KEY:
        MOV     AH,7           ; Function Call
    
```

• U T I L I T I E S •

FILE DELETE

```

INT      21H          ; Get a character from Keyboard
CMP      AL,ESC       ; Was it Escape?
JZ       QUIT        ; Yes - so Quit
CMP      AL,'Y'       ; was it a 'Y'?
JZ       ERASE       ; Yes - so erase file
CMP      AL,'y'       ; was it a 'y'?
JZ       ERASE       ; Yes - so erase file
CMP      AL,'N'       ; Was it 'N'
JZ       NOTERASE    ; Yes - so don't erase
CMP      AL,'n'       ; Was it 'n'
JZ       NOTERASE    ; Yes - so don't erase
JMP      GET_KEY     ; Get another Keystroke
    
```

ERASE:

```

MOV      DL,AL        ; Character to Display
MOV      AH,2         ; Function Call
INT      21H         ; Display DL
MOV      DX,TAIL     ; Point to FCB of file last found
MOV      AH,13H      ; Function Call
INT      21H         ; Delete file
JMP      NE2         ; Jump Display call
    
```

NOTERASE:

```

MOV      DL,AL        ; Character to Display
MOV      AH,2         ; Function Call
INT      21H         ; Display DL
    
```

NE2:

```

MOV      DX,FCB       ; Get next matching entry
MOV      AH,12H      ; Function Call
INT      21H         ; Search for next file
CMP      AL,0         ; Is there one?
JZ       SEARCH      ; Yes - so go again
    
```

QUIT:

```

MOV      AX,4C00H    ; EXIT Code
INT      21H         ; Return to DOS
    
```

CODE ENDS

END START

in this case `Prt_Loop`. The loop will be processed 11 (0Bhex) times, displaying one character at a time from the Tail area where the found file name was stored. Processing continues by completing the display line with the (Y/N)? message, using function 9 of Interrupt 21hex.

The message

DELETE FILE EXT (Y/N)?

is now displayed on the screen, and a response is required from the operator. This response is obtained by the `Get_Key` routine using function 7 of Interrupt 21hex. Function 7 waits for a key to be pressed before returning with the code of that key in register AL. The remainder of the code in the `Get_Key` routine simply checks the returned character to see if it is Y or N — in upper or lower case — or Esc. If the returned code is none of these, processing returns back to the start of `Get_Key`. Otherwise, processing is routed to Erase, Not-Erase or Quit. The `Get_Key` routine does not produce any output to the screen, so at the beginning of Erase and Not-Erase the character is placed in DL, and function 2 is used again to display it.

Erasing the selected file is done using Function 13hex of Interrupt 21hex. It requires that DS:DX point to the FCB of the required file, and this is just what DOS has created in the command tail area. This address can therefore be loaded into DX and the delete function can be called. A little jump is needed to take processing over the character display function at `Not_Erase`.

The final step in the overall process is to search for another file that matches the FCB at 5Chex. This is done in exactly the same way as at label `Continue`, but this time using function 12hex, which finds the next file match. If this is successful then processing returns to label `Search` and the operator is prompted for the next file.

If the Find Next File function is not successful, or if the Escape key has been pressed, processing passes to label `Quit`. This calls Function 4Chex of Interrupt 21hex, which is the approved way of terminating a program's operation and returning gracefully to DOS. □

All the programs in this series are available on IBM-formatted discs at a cost of £5 for each program. Each disc contains the assembler source code, the assembled program and a document file describing the operation of the code in detail. Please send your order to Jim Bates, c/o Practical Computing; cheques should be made payable to Jim Bates.

LISTING 2. DATA FOR BASIC LOADER

Line 1	? 233,	156,	0,	66,	65,	84,	69,	83,	32,	65,	853
Line 2	? 115,	115,	111,	99,	105,	97,	116,	101,	115,	13,	987
Line 3	? 10,	77,	117,	108,	116,	105,	112,	108,	101,	32,	886
Line 4	? 70,	105,	108,	101,	32,	68,	101,	108,	101,	116,	910
Line 5	? 105,	111,	110,	32,	86,	101,	114,	115,	105,	111,	990
Line 6	? 110,	32,	49,	46,	50,	48,	13,	10,	36,	13,	407
Line 7	? 10,	68,	69,	76,	69,	84,	69,	32,	32,	32,	541
Line 8	? 36,	32,	40,	89,	47,	78,	41,	63,	32,	36,	494
Line 9	? 78,	111,	32,	77,	97,	116,	99,	104,	105,	110,	929
Line 10	? 103,	32,	70,	105,	108,	101,	115,	32,	70,	111,	847
Line 11	? 117,	110,	100,	13,	10,	36,	80,	108,	101,	97,	772
Line 12	? 115,	101,	32,	117,	115,	101,	32,	68,	76,	84,	841
Line 13	? 32,	108,	105,	107,	101,	32,	116,	104,	101,	32,	838
Line 14	? 68,	73,	82,	32,	99,	111,	109,	109,	97,	110,	890
Line 15	? 100,	32,	32,	101,	103,	58,	32,	68,	76,	84,	686
Line 16	? 32,	42,	46,	66,	65,	75,	13,	10,	36,	141,	526
Line 17	? 22,	3,	1,	180,	9,	205,	33,	190,	128,	0,	771
Line 18	? 138,	4,	60,	1,	125,	11,	141,	22,	106,	1,	609
Line 19	? 180,	9,	205,	33,	235,	112,	144,	186,	92,	0,	1196
Line 20	? 180,	17,	205,	33,	60,	0,	116,	10,	141,	22,	784
Line 21	? 80,	1,	180,	9,	205,	33,	205,	32,	141,	22,	908
Line 22	? 59,	1,	180,	9,	205,	33,	187,	129,	0,	180,	983
Line 23	? 2,	185,	11,	0,	138,	23,	67,	205,	33,	226,	890
Line 24	? 249,	141,	22,	71,	1,	180,	9,	205,	33,	180,	1091
Line 25	? 7,	205,	33,	60,	27,	116,	51,	60,	89,	116,	764
Line 26	? 14,	60,	121,	116,	10,	60,	78,	116,	22,	60,	657
Line 27	? 110,	116,	18,	235,	230,	138,	208,	180,	2,	205,	1442
Line 28	? 33,	186,	128,	0,	180,	19,	205,	33,	235,	7,	1026
Line 29	? 144,	138,	208,	180,	2,	205,	33,	186,	92,	0,	1188
Line 30	? 180,	18,	205,	33,	60,	0,	116,	166,	184,	0,	962
Line 31	? 76,	205,	33,	0,	0,	0,	0,	0,	0,	0,	314

display the file name the program sets up the CX register as a counter to enable display of just 11 characters. There is no \$ sign to signal the end of the displayed message.

Processing can now move into the display loop. Function 2 will display the character in DL, so the character pointed to by BX is moved into DL ready for display. The BX register is then incremented to point to the next character, ready for the next time round the loop. Interrupt 21hex displays the character, and then the Loop command is processed.

The Loop command is one of the machine-code instructions that processes on a conditional basis. It first subtracts 1 from the CX register, and then checks to see if the answer was zero. If it was, processing continues with the next instruction. If CX was not zero, processing branches to the location specified in the Loop command —

CLASSIFIED

PRACTICAL COMPUTING,
 REED BUSINESS PUBLISHING
 QUADRANT HOUSE
 THE QUADRANT
 SUTTON SURREY SM2 5AS
 TEL: 01-661 3033

SoftOscilloscope

Turn your BBC B, B+ or Master into a powerful tool for fast real-time data collection, display and analysis. Free PCB to create a cheap A/D converter included; also works with other standard converters.

Education Version (EPROM, disk, manual) £49.95 inc. VAT & Postage.

Professional Version : open access system (2 EPROMs, 3 disks, 2 manuals) £199 inclusive.

Individuals send cheque/Amex/Visa/Access with order.

Elsevier - BIOSOFT
 68 Hills Road, Cambridge,
 CB2 1LA, U.K.



COMPUTER CONSUMABLES
 3M Diskettes

3 1/2" 5 1/4" 8"
 SS.DD DS.DD DS.QD

Typewriter & Printer Ribbons
 Originals & Compatibles
 Printwheels
 Singleplastic, Doubleplastic, Metal

Tel: Potters Bar
(0707) 44455

IT REALLY IS MAGIC!



Thinking of buying a Computer, Accessories, Printers or Software? Why not save up to 40% Contact Rocketfield, PRC1, 86 Birch Hall Lane, Manchester 13. Tel. 061-224 4032

WE GUARANTEE THE LOWEST PRICES

Don't forget to ask for your 'Magic' Order form

ROCKETFIELD
 computer systems



EXPANSIONS AND UPGRADES

30110 Floppy Disk Controller for XT, 2+300K Drives	£28.00
30133 Colour Graphics Card, 320x200 Res.	£56.00
30140 Monochrome Video Card, 80+25 Characters only	£56.00
30150 Monochrome Graphics Printer Card	£59.00
30180 Enhanced Graphics Card	£725.00
30200 Multi I/O with Floppy Controller	£78.00
30210 Multi I/O Card	£58.00
30220 Serial Card, 1-3 optional	£24.00
30230 Parallel Printer Card for AT	£16.00
30240 64k Buffered Printer Card with 10k RAM	£19.00
30250 Game I/O Card, 2 Channels	£14.00
30260 384k Multifunction Card supplied without RAM	£59.00
30270 Serial/Parallel Card for AT	£56.00
30280 512k Memory Expansion Card supplied without RAM	£28.00
30290 Clock Card	£25.00
30300 2 5MB RAM Card for AT, supplied without RAM	£126.00
30310 2 5MB Multichip Card for AT, supplied without RAM	£165.00
30320 Hard Disk Controller for XT	£129.00
31100 AD/DA Card, 12 bit	£98.00
31150 Eprom Writer	£117.00
31180 Eprom Writer 48 Testbed sockets	£152.00
31190 PAL Programmer Card	£314.00
31210 8255 I/O Card	£59.00
31220 4 Channel RS232 Card for PC/XT	£138.00
31225 4 Channel RS232 Card for AT	£156.00
31230 8 Channel RS232 Card for PC/XT	£249.00
31235 8 Channel RS232 Card for AT	£315.00
31240 8 Synchronous RS232 Communications Card	£85.00
34010 Inverters	£15.00
34020 Mouse	£49.00
34100 PC/XT Standard Keyboard Type 5050, PC/XT only	£49.00*
34105 AT Style Keyboard Type 5051, PC/XT/AT	£56.00*
34110 Selectric Style Keyboard Type 5151, PC/XT/AT	£73.00*
34200 XT 8 Slot Cabinet	£56.00*
34310 150 W Power Supply Unit for PC/XT	£79.00*
34320 200W Power Supply Unit for AT	£149.00*
35120 PC/XT 20MB Upgrade Kit, 85nS, with cert. cabs. etc.	£368.00*
35130 PC/XT 30MB Upgrade Kit, with cert. cabs. etc.	£468.00*
38220 PC/XT 20MB Hardcard	£399.00*
38230 PC/XT 30MB Hardcard	£499.00*

Please add £1 on item (£4 per item marked *) and 15% VAT and send your order for phone with VISA or ACCESS number to

Western Technology

PO Box 312, Wixham, Cleveley, LE12 0XK
 0246 571877

PROTECT DATA EXTEND HEAD LIFE REDUCE ERRORS

WITH **FLOPPY CLEANICA**

THE UNIQUE
 MICROWAVE-MACHINED
 SOFT POLYESTER
 CLEANING DISC

Safe design containing no magnetic materials or compounds. No messy liquids or 'one time' cleaning pads. Simple 15 second cleaning cycle for both double or single sided drives. Economic lifespan gives 150 operations with usage chart

FLOPPY CLEANICA is manufactured by Audio Technica, a world-wide name in precision made products, and maintains disc drive heads in optimum condition for minimum read/write error. Order directly today by mail (cheque/p.o.) or credit card telesales.

FLOPPY CLEANICA £19.95 INC. P&P
 Please state 5.25" (ATC-205) or 3.5" (ATC-203) DRIVE

audio-technica
 Technica House, Lockwood Close, LEEDS LS11 5UU.
TELESALES (0532) 771441

Thanks for the Memory

For the BBC (B, B+, Master)

OVERLAY BASIC

Transparent, easy to use. Lets your BBC BASIC programs call procedures from disk, use them, then forget them until next needed. Programs now needing 64K RAM may only need 5K RAM. Runtime module allows other BBC users to run the programs from disk without the chip.

£29.95 inc. VAT + p&p

Available only from:

Elsevier - BIOSOFT
 68 Hills Road · Cambridge CB2 1LA
 Telephone (0223) 68622 · Telex 81623

SCREENWISE

APEX HOUSE
 18 HOCKERILL ST.
 BISHOPS STORTFORD
 HERTFORDSHIRE CM23 2DW
 TEL. (0279) 59343
 TELEX 817547

**AMSTRAD PC AND PCW
 MICROS WITH VT100
 TERMINAL EMULATION, FILE
 TRANSFER AND
 NETWORKING**

ALSO VT52, ADDS, TELEVIDEO,
 ADM, etc, etc
 PRESTEL and COMMUNICATIONS
 CUSTOMISED KEYBOARDS AND
 TERMINAL EMULATIONS

Southern sales: (0279) 59343. FULL TECHNICAL SUPPORT & ADVICE
 Northern sales: (0606) 553433 SERVICE & MAINTENANCE CONTRACTS



VT52 and VT100 are trade marks of Digital Equipment Corporation

COMPUTER CLEANERS

****STOP LOCK UPS****

Do you suffer lost data or lock-ups? Do you think mains is the cause? If so then our sockets may be the solution.

As well as cutting high voltage spikes they smooth the cut spikes and filter RF from 1-30MHz (better than 400 spike filters and up to 130MHz.

Now with Three spike filters
 Adaptor (socket) (5a fuse) — £14 incl.
 Adaptor (3 sockets) (5a fuse) — £18 incl.
 Trailing 4-way socket (13a fuse) — £24 incl.
 Simply plug In — no wiring

Telex: 285451 MONREF G (quoting BT GOLD 72: MAG30645)

Tony Firshman Services
 12 Bouverie Place London W2 1RB 01-724 9053

**COPY DEADLINE
 JUNE 3
 FOR JULY ISSUE**

PERFORM IN-CIRCUIT EMULATION CHEAPER WITH THE NEW ICE-KING. SINGLE STEP OR BREAK POINT PROGRAMS — TEST RESULTS IMMEDIATELY! SYSTEM CONSISTS OF POD WITH FLAT CABLE CONNECTORS, PLUS A 2764 EPROM TO PLUG INTO ROM (SIDEWAYS) SOCKET. IDEAL FOR SMALL SYSTEM DEVELOPMENT, EDUCATION, TRAINING, ROBOTICISTS, ETC.

COMPLETE SYSTEM £250 + VAT S.A.E. FOR FURTHER DETAILS: ICE-KING, LANCASTER CONSULTANTS, PO BOX 65, LANCASTER LA1 1PG

ICE KING
THE IN-CIRCUIT EMULATOR
TURN YOUR BBC 'B' INTO A COMPLETE DEVELOPMENT SYSTEM FOR 6502-BASED TARGET COMPUTERS

When replying to Classified advertisements, readers are recommended to take steps to protect their interests before sending money.

SIRIUS EXPANSION: 512K RAM, £185, clock + card £65. New ROM's £32 (inclusive). ISSUE. 18 Norfolk Road, Brighton BN1 3AA. (0273) 736880. 457M.

OSBOURNE 1 portable CP/M computer. Twin disc drive + spare monitor software; Wordstar, Supercalc, Cardbox, SAGE Estimating, CBASIC, MBASIC, Bookkeeper. Offers around £300. Contact Tim Atkinson or Bob Johnson on 0732 865023 (Office hours). 456M.

SIRIUS MS-DOS CP/M-86. 256K. RAM with Epson FX80 printer. All reference manuals and guides. Little used. Offers please. (0342) 892142 anytime. 455M.

IBM PC with 8086 board 4.77/10Mhz clock, 640K RAM, twin floppies plus 20/20 Mbyte, hard disk/tape streamer monitor, keyboard and manuals, £995, RICOH 1600Q 55cps, daisywheel printer as new, £495. FACIT 40cps daisy wheel with sheetfeeder, £545, QUME 11/40 printer £450. 01-886 4200. 454M

FUTURE COMPUTERS. Three Future FX30 Microprocessors each with 250K memory, 10 MEG. Hard Disk Drive, one 760K floppy drive, also one 256K FX20 with one 760K floppy drive. 8086 processors, CP/M 86, WORDSTAR, DATASTAR, DBASEII and CBASIC. 1 PAPER TIGER and 1 STAR-WRITER PRINTERS. OFFERS — Contact K.M McGrath. 01-505 3366. 453M

MBASIC Compiler Vers 5.3 Manual & disc, IBM 3740 format, £100. Phone: Colwyn Bay (0492) 533935 (evenings). 452M

NORTH STAR Horizon, 12-slot-5100. Dual-drive computer VC404 terminal customised for Wordstar, software, technical manuals offers £1,000. Diablo 1650 daisy wheel printer with assorted wheels. Offers £1,000. Tandy Model IV 128K, dual-drive computer with TRSDOS, LDOS, DESPLUS, TRS-CPM Montezuma CP/M and other software offers, £850. Phone: 021-358 7572 between 7.30pm and 10.30pm only. 451M

EPSON PX-8 portable with 120K RAM, rechargeable 3 1/2" drive and video display controller UD80. Offers £700. Phone: 021-358 7572 between 7.30pm and 10.30pm. 450M

STOCK CLEARANCE (discontinued IBM-PC lines), MyWord Word Processor — £249 (list £350) "arguably the most flexible WP package for the PC" (PC User). Dacom DSL2123 modems 300/1200 baud — £145 each (list £265) Quickcode for dBASE II, only £39. Also Epson Print Controller down to £19, STD (lookup STD codes), only £49 (all prices + VAT). Tel: I-C-C-S Congleton (0260) 270870. 448M

QL + Printer + Software + Manual etc. Little used £100. Call: 01-661 3300 (daytime). 449M

RAIR BLACK BOX and ICL PCs (8 bit). Bought sold exchange repaired advice given. Ring 0734 668951 (Reading). 267M

SIRIUS/IBM & Compatibles Public Domain software Incl. Transfer pack send large sae to M. Palaci 122 Kilburn High Road, London NW6 4HY.

ATARI ST USERS send stamp for FREE NEWSLETTER S.P.D. Software details. ST-CLUB (PC187), PO BOX 20, Hertford, SG13 8NN.

ATARI ST OWNERS — Write now for a free copy of our latest Newsletter and Public Domain Library Catalogue: St-Club, PO Box 20, Hertford, SG13 8NN. (stamp appreciated).

IBM-PC Public Domain Software from only £3/disc. NO MEMBERSHIP FEES. Send S.A.E. for catalogue to: PC-STAR, P.O. BOX 164 Cardiff CF5 3YB.

NEWBRAIN newsletters 1-18, Technical manual, handbook £16. Sixty-four volumes of Public Domain Software at £3 each. List of hardware and software disks, expansions terminal etc. GFG Microsystems FREEPOST Cambridge CB4 1BR.

CANON PJ1080A colour ink jet. Printer, brand new, IBM-PC compatible. New, price £500 + . For sale at £350 ono. Tel: 01-836 8751 ext 252 office. 0931-226786. Evenings. 458M

80286 SPEEDCARD Upgrades PC or XT giving AT performance (supports 80287) £225. EGA Card £169. Both new also many Apple items. 01-736 7809.

EPSON PX-8 Portable Computer. 120K Ram Disk plus all Software, Manuals and Cables. £600 o.n.o. 0483-66146 Evenings.

DISK COPYING SERVICE

Moving data and program files from one machine to another is often made difficult because different manufacturers have adopted different disk format standards.

We can copy your files to and from over 250 disk formats including CP/M, CP/M-86, MS-DOS, PC-DOS, ISIS, APPLE, SIRIUS, TORCH, APRICOT, HP150, DEC RT-11, and IBM BPF.

Disks are normally despatched on the day they are received.

Our charge is £10.00 + disk + VAT. Special prices for quantities.

For more information call us.

GREY MATTER

4 Prigg Meadow, Ashburton, Devon TQ13 7DF
TEL. (0364) 53499 10

COMPUTER PROBLEMS?

WE HAVE THE SOLUTIONS

Not all data switches and converters are the same. Check these features when selecting your next purchase.

DO THEY INCLUDE:	Us	Them
*Computer and Printer Cables	✓	?
Direct from manufacturer from stock	✓	?
Attractive styling and small size	✓	?
No quibble guarantee	✓	?
Experienced technical support	✓	?
Competitive pricing	✓	?
1st class postage and packing	✓	?
Customised versions available	✓	?

WE DO!

*Converters include printer cables. Additional Cables at reduced prices. Ring us for quotation or further information about our comprehensive range of data switches, data converters and low cost computer cables; or write to (no stamp required).



TYPRO LIMITED

Freepost, 30 Campkin Road, Cambridge CB4 1BR
Telephone: (0223) 322394

ATARI-ST

PUBLIC DOMAIN SOFTWARE

We probably have the most extensive collection of ATARI-ST public domain software in the U.K.

Over 100 disks are packed with Desk Accessories, Comms software, Games, Utilities, Music and Languages. And the list is growing daily!

Send an SAE for our most recent list to:
SEE US ON STAND 131 AT THE ATARI USER SHOW

THE SOUTH WEST SOFTWARE LIBRARY
5 Barn Owl Way, Stoke Gifford, Bristol, Avon BS12 6RZ

GENTUN INFORMATION SERVICES

Will be opening their new premises at Regent House, Heaton Lane, Stockport.

We will provide office systems for accounting, Data Management, Word Processing etc.

Helpful advice and setting up the most efficient system to suit your business requirements.

GENTUN INFORMATION SERVICES
REGENT HOUSE
HEATON LANE, STOCKPORT

PC/AT COMPATIBLES

BREAKING THE PRICE BARRIER!!!!!!
 MANUFACTURED IN THE UNITED KINGDOM
 USING HIGHEST QUALITY JAPANESE PRODUCTS

PC/XT £380
PC/XT, 20MB,
MONITOR TTL £780

★ 8088/V20 ★ 640k
 ★ "NEC" FLOPPY DRIVE ★ "SERIAL/PARALLEL" PRINTER PORT
 ★ HERCULES GRAPHICS DISPLAY ADAPTOR ★ KEYBOARD NUMS +
 CAPS LOCK ★ 8 SLOTS ★ FLAT SCREEN MONITOR

AT/TURBO £949
WITH 20MB
MONITOR £1280

★ DYNAMIC SPEED CONTROL ★
 ★ 80286 6/8/12 MHZ ★ 512K RAM EXPANDABLE TO 1M
 ★ LEGAL BIOS ★ FLOPPY DRIVE 1.2M
 ★ PRINTER PORT ★ GRAPHICS DISPLAY ADAPTOR ★ AT STYLE KEYBOARD
 WITH SEPARATE CURSOR PAD

★ **NEW 386 TURBO £2900** ★
 MONITOR, 20MB HARD DISK, 640K RAM, 1.2MB FLOPPY KEYBOARD, DOS 3.2
 ALL SYSTEMS ARE TOTALLY COMPATIBLE
 HI REST TTL MONITOR 169 20MB HARD DISK £299
 BILINGUAL SYSTEMS EXPORT ORDERS WELCOME
 12 MONTHS WARRANTY AND SUPPORT INCLUDED PRICES EXCLUDING VAT
 FOR ORDERS AND ENQUIRIES PLEASE CONTACT

C.A.S. COMPUTER POINT LTD
TEL 01-708 3775/01-708 2734
TLX 8952387 ANSWER G

→ circle 159 on enquiry card ←

IBM COMPATIBLE Cards/Peripherals at unrepeatable prices

Mother Board W/Legal Bios.....	£98.00
Computer Case Baby at.....	£50.00
Computer Case AT.....	£60.00
Power Supplies XT (150w).....	£89.00
Power Supplies AT (209w).....	£125.00
Keyboard English XT/AT.....	£75.00
Multi I/D Card 2 x RS232.....	£70.00
Colour Graphics Display.....	£89.00
RS232 Card.....	£36.00
Parallel Card.....	£25.00
Hard Disk Card.....	£76.00
I/O Card 2 x RS232.....	£70.00
Slim Line Dual Disk Drive Cases.....	£25.00 with cable
Hard Disk Drive Seagate 20 MB.....	£295.00

*Cables and Connectors for your requirements.
 All prices exclude VAT*

Cambridge Computer Solutions

42 Clifton Industrial Estate
 Cambridge CB1 4ZZ

Tel: (0223) 213374 Fax (223) 410291

*Free Delivery for orders
 over £50.00. plus VAT*



EX STOCK

→ circle 160 on enquiry card ←

PRactical COMPUTING

Advertisement Index

A		E		M		R	
ABC Systems Ltd	11	Elite Computer Systems	74	MCS	100	Ringdale Electrical	8
AMA Advanced Micro		Elonex	Inside Back Cover	MDS	28		
Application	26	Epson (UK) Ltd	14/15	Megatech Corporation	77	S	
Amstrad Consumer Electronics	24/25			Mekom Computer Products	48	Seltec Computer Products	18/19
Apricot UK	30/31	F		Microft Technology Ltd	20 94	Sharp Electrical (UK) Ltd	44/45
Atari UK	32/33 35	Fraser Associates	94	Micronix Computers	70/71	Silica Shop	69
		Fuji Photofilm (UK) Ltd	29	Micro Peripherals	Back Cover	Star Micronics (UK) Ltd	13
B		Fujitsu Europe Ltd	62/63	Micro Rent	49	System Science	107
Barbatan Ltd	60			Microcosm Research	22		
Borland Intep	Inside Front Cover	H		Mill Computers	107	T	
3		Homestead Data Products Ltd	66	Mountandere	107	Trisoft Ltd	61
Brom Com	41			M Tec	94		
British Olivetti	4					W	
				O		Walters International Ltd	40
C				Olympia International			
Cambridge Computer Solutions	114	I		Opus Supplies Ltd	38	Z	
CAS Computer Point	114	Institution Analysts	104	Orchid Europe	84	Zorland Ltd	95
Ceratech Electronics	76	Programmers	64				
Compumart	23	Interface Systems	88	P			
Computer Express	56	ISD International		Peter Nelson Design	104		
Cristie Data Products	104			Plus 5	80		
Crotan Electronics	74	K		Polankep Video	104		
		Keyzone Ltd	66	Polaroid UK	6		
D						Q	
Damson Computing	104	L				Qume UK	36
Data Dynamics	83	Livingston Hire Ltd	16/17				
Dataplus C Sales	66	Logotron Ltd	88				
Digithurst Ltd	76						
Disking International	52/53						

XT-Compatible 20 Megabytes 4.77/8 MHz

£795

- The PC88 Turbo
- Legal BIOS
- NEC V-20 Super Processor
- Switchable 4.77/8 MHz Clock
- 640K RAM
- 20MB Half Height Hard Disk
- 360K Half Height Floppy
- Parallel Printer + RS232 Serial Ports
- Clock/Calendar with Battery Back-up.
- Monographic/Printer card
- 130W Power Supply
- Professional Keyboard
- "Hi-Res 12"" Green Monitor
- MS-DOS 3.2
- Full Set of Manuals
- 8 Expansion Slots
- 12 Months Warranty

AT-Compatible 20 Megabytes 6/8/10 MHz

£1295

0 or 1 Wait States

- The PC-286 Turbo
- Legal Bios
- Switchable 6/8/10 MHz
- 640K RAM
- 20 MB Half Height Hard Disk
- 1.2 MB Half Height Floppy
- Parallel Printer + Two RS232 Serial Ports
- Clock/Calendar with Battery Back-up
- Monographic/Printer card
- 200W Power Supply
- Professional Keyboard
- "Hi Res 14"" Green Monitor
- MS-DOS 3.2
- Full Set of Manuals
- 8 Expansion Slots
- 12 Months Warranty

OPTIONS

- 30 MB Hard Disk Drive Upgrade £265
- 40MB Hard Disk Drive Upgrade £365
- 14" Colour Monitor Upgrade £175
- 14" Hi Res Colour Monitor and EGA Card Upgrade £395
- EGA Card £165

'ON SITE MAINTENANCE AVAILABLE'



ELONEX (UK) Ltd.

Please feel free to visit our showroom for demonstration

**RAYS HOUSE, NORTH CIRCULAR ROAD, STONEBRIDGE PARK,
LONDON NW10 7XB TELEPHONE: 01-965 3225**



MP 165 DOT MATRIX

This proven best selling NLQ printer offers the user the very best in low cost matrix printing.
Speed: 160cps (Draft), 35cps (NLQ).
Columns: 80. **Compatibility:** IBM/Epson. **Price:** £229.



MP 200 DOT MATRIX

A fast NLQ quality printer, using the latest state of the art technology - IC Font Cards.
Speed: 200cps (Draft), 40cps (NLQ).
Columns: 80. **Compatibility:** IBM/Epson. **Price:** £329.



MP 201 DOT MATRIX

This 136 column, 200cps, NLQ printer offers the best value in the market place - you can't buy better. A range of Font Cards are available.
Speed: 200cps (Draft), 40cps (NLQ).
Columns: 136. **Compatibility:** IBM/Epson. **Price:** £349.

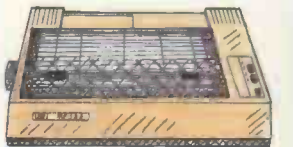

MP 135 DOT MATRIX

A low cost, high performance printer using the latest technology to produce print that makes draft quality look like NLQ.
Speed: 135cps (Draft), 27cps (NLQ).
Columns: 80. **Compatibility:** IBM/Epson. **Price:** £169.



MP 480 DOT MATRIX

Another prime example of Micro Peripherals bringing fantastic value for money in a 480cps dot matrix printer at less than a pound per character per second.
Speed: 480cps (Draft), 74cps (NLQ).
Columns: 80. **Compatibility:** IBM/Epson. **Price:** £369.



MP 26 DAISY WHEEL

A feature rich very quiet (57dB) printer. Universal compatibility with almost all personal computers at an unbeatable price.
Speed: 26cps. **Columns:** 132.
Compatibility: Diablo 630 Interface: Parallel + serial. **Price:** £259.



MP 40 DAISY WHEEL

A very fast, quiet printer packed with features and compatible with virtually all computers and at a fantastic price.
Speed: 40cps. **Columns:** 132.
Compatibility: Diablo 630 Interface: Parallel + serial. **Price:** £379.

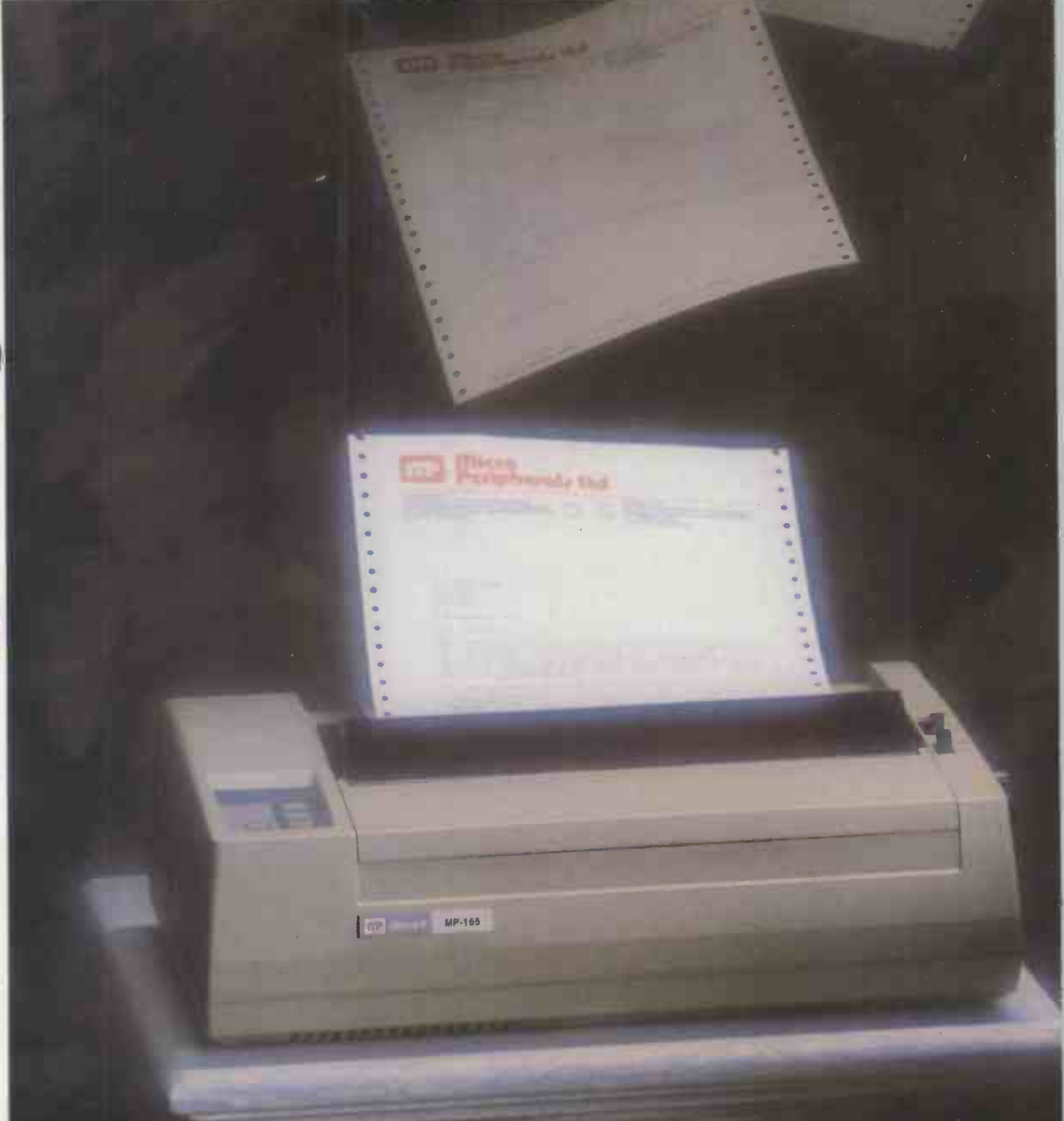

Our printer's produce words faster than you can say them (at prices we like to shout about).

Producing words isn't the only thing Micro Peripherals printers do fast. With quality features you'd normally find on more expensive machines, they sell fast as well.

Whether you want high speed performance, high resolution graphics or a choice of type styles to make you look good on paper, the Micro Peripherals range has the printer to suit your needs and your pocket, as well as a full 2 year warranty.*

Micro Peripherals printers are compatible with most micros, including Amstrad, IBM, Acorn and Compaq. For more information call us for free on 0800 521111 now.



Intec 2, Wade Road, Basingstoke, Hampshire RG24 0NE.
Telephone: 0256 473232.
Telex: 859669 MICRO P G Facsimile: 0256 461570.

Units 5 & 6, Newhallhey Road, Rawtenstall,
Rossendale, Lancashire BB4 6HL.
Telephone: 0706 211526 Facsimile: 0706 228166.

* The 2 year warranty excludes printheads and ribbons. All prices are RRP Ex. VAT. IBM, Epson & Diablo are trade marks and are recognised.